

CONTENTS:

About these Instructions for Use 1
 Information on safety..... 2
 Safety notices 2.1
 Safety symbols..... 2.2
 Regulations regarding ASA..... 2.3
 Intended use..... 2.4
 Predictable incorrect application... 2.5
 Product description 3
 Application examples..... 3.1
 Checklist 4
 Before installation..... 4.1
 After installation..... 4.2
 Important information..... 4.3
 Repair 4.4
 Dismantling, waste disposal... 4.5
 Mounting 5
 Mounting the electronic unit 5.1
 Electrical connection 5.1.2
 Connection overview 5.1.3
 Mounting the probes 5.2
 Suspending the probes..... 5.2.1
 Electrical connection
 of the probes 5.2.2
 Commissioning 6
 Operation..... 7
 Alarm..... 7.1
 Layer alarm..... 7.1.1
 High level alarm..... 7.1.2
 Sludge alarm..... 7.1.3
 Alarm probes error..... 7.1.4
 Maintenance..... 8
 Function test 8.1
 Probes maintenance 8.2
 Troubleshooting. 8.3
 Spare parts 9
 Technical data..... 10
 Appendix..... 11
 Declaration of Conformity (DoC).... 11.1

Save this manual for future reference!

Version 1.0, 01.08.2024

ASA-02

Separator alarm

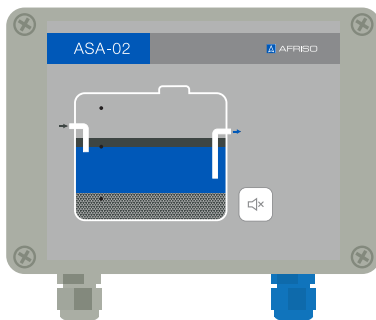

Afriso Ema AB

Kilvågen 2 • SE-232 37 Arlöv

Tel.: +46 (0)40-92 20 50

www.afriso.se



1 About these Instructions for Use

These instructions describe the ASA-02 separator alarm and associated probes. These instructions for use are part of the product.

- You may only use the product if you have read and fully understood the instructions for use.
- Make sure that this manual is always available for all types of work performed on or with the product.
- Provide these Instructions for Use and all other product related documents to all owners of the product.
- If you believe that these Instructions for Use contain errors, inconsistencies, ambiguities or other problems, please contact the manufacturer before using the product.

This manual is protected by copyright and may only be used in accordance with the corresponding copyright laws. We reserve the right to change the instructions.



The manufacturer may not be held liable in any way for direct or consequential damages resulting from a failure to comply with these instructions or from a failure to comply with directives, regulations and standards and any other statutory requirements applicable at the place of installation of the product.

2 Information on safety



2.1 Safety notices

These instructions contain safety notices to alert you to potential hazards and risks. In addition to the instructions in this manual, you must comply with all directives, standards and safety regulations that apply at the product’s installation site. Verify that you are familiar with all directives, standards and safety regulations and ensure that they are followed before using the product. Safety notices in this manual are marked with warning symbols and warning text.

2.2 Safety symbols

SYMBOL	DESCRIPTION
	Critical warning, risk of injury
	Warning risk of damage to equipment or personal injury
Note !	Attention is required
	Things to consider if there is a risk of explosion

2.3 Regulations regarding ASA

SYMBOL	DESCRIPTION
Note !	Read the instructions before installation
	Installation must only be carried out by an authorised installation technician
	The intrinsically safe circuit must not be connected to earth.
	When connecting within an Ex area, observe regulatory requirements

2.4 Intended use

This separator alarm is an associated apparatus designed to be placed outside the hazardous area. Its relay outputs and power supply are internally galvanically isolated from the intrinsically safe output to which external sensors in one intrinsically safe circuit are intended to be connected.

Any use other than the application explicitly permitted in these operating instructions is not permitted and causes hazards.

Verify that the product is suitable for the application planned by you prior to using the product.

In doing so, take into account at least the following:

- All directives, standards and safety regulations applicable at the installation site of the product
- All conditions and data specified for the product
- The conditions of the planned application

In addition, perform a risk assessment in view of the planned application, according to an approved risk assessment method, and implement the appropriate safety measures, based on the results of the risk assessment. Take into account the consequences of installing or integrating the product into a system or a plant.

When using the product, perform all work and all other activities in conjunction with the product in compliance with the conditions specified in the operating instructions and on the nameplate, as well as with all directives, standards and safety regulations applicable at the installation site of the product.

2.5 Predictable incorrect application

The product must never be used in the following cases and for the following purposes:

- Hazardous area (applicable to control unit)
 - If the product is operated in hazardous areas, sparks may cause deflagrations, fires or explosions.
- In rooms that are subject to high humidity (such as bathrooms)
- Interconnection of product and signal transducer whose intrinsic safety parameters do not match

3 Product description

ASA-02 is an EX-classified grease and oil separator alarm consisting of an electronic unit that can be connected to 1 to 3 digital ASA probes. The electronic unit is designed to be mounted directly on a wall and is equipped with IP65 enclosure.

Do not install the unit in rooms with an explosive atmosphere.

3.1 Application examples

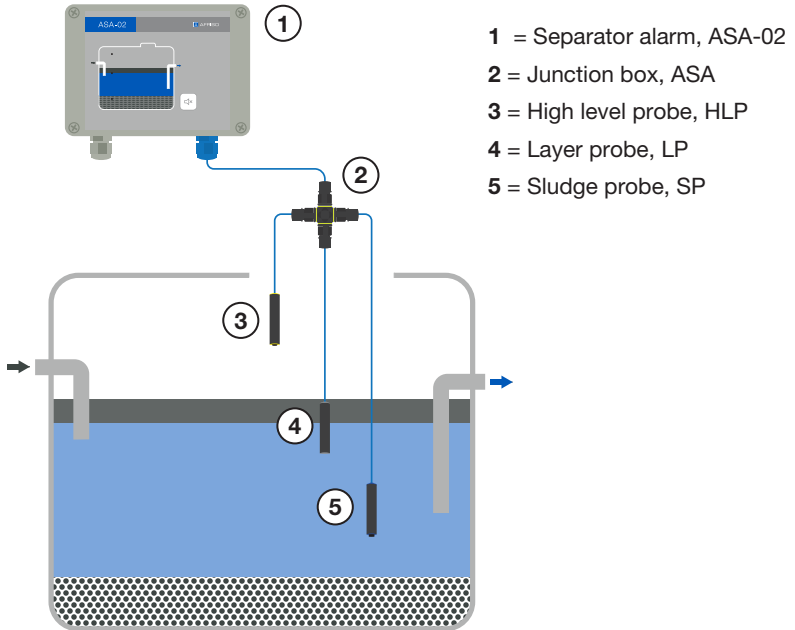

- 1 = Separator alarm, ASA-02
- 2 = Junction box, ASA
- 3 = High level probe, HLP
- 4 = Layer probe, LP
- 5 = Sludge probe, SP

- Separator alarm ASA-02 (1) with an intrinsically safe design and probes that is EX-approved for installation and use in areas with an explosion risk. The unit has 3 potential-free relay outputs that can be connected to external alarms or external monitoring.
- Junction box ASA (2) for connection of 1-3 probes. IP68
- ASA-HLP (3) is an ultrasonic level probe used to detect a rising level of fluid
- ASA-LP (4) is a capacitive layer probe that triggers an alarm when the oil/ grease layer exceeds the preset alarm level
- ASA-SP (5) is an ultrasonic level probe that triggers an alarm when the level of sludge, sand and other solids exceeds the predetermined level

The electronics unit is equipped with an overview image of a separator with status diodes for the probes and a mute button.

4 Checklist

4.1 Before installation

- Do you have the skill sets required for performing electrical installation? Observe relevant Ex regulations and regulatory requirements, especially EN60079-14 and EN60079-17.
- All-pole switches should not be installed to prevent disconnection of alarm function
- Extension cables for probes, at least 2 x 0.75 mm², max. 500 metres
- Be sure to check the regulations and assembly instructions for your specific facility

4.2 After installation

- Check the wiring of the electronic unit and the cable area.
- Flatlist for lid mounted on electronic unit and lid closed
- Check the mounting position of the probes according to separator manufacturer recommendations
- Make sure that the separator is filled with water according to the manufacturer's recommendation before performing the probes functional check
- Turn on power and follow instructions in manual
- Do a functional check according to the commissioning instructions

4.3 Important information

These instructions for use form the basis for certification of the explosion protection of type ASA separator alarms according to certificates DNV 23 ATEX 86944X and IECEx DNV 23.0056X.

The unit is supplied with a cable gland or a cable grommet.

Only a cable of suitable outer diameter may be used in accordance with the installation regulations. Unused connections must be suitably plugged.

4.4 Repair

It is not permitted to repair the electronic unit in the event of a fault. The unit must either be replaced or sent to Afriso Ema AB for fault diagnostics/examination.

4.5 Disassembly, waste disposal

Dispose of the product pursuant to all applicable directives and standards and safety regulations. Do not discard electronic components together with normal household waste.

5 Mounting

5.1 Mounting the electronic unit

Note ! Read the instructions before installation



Installation must only be carried out by an authorised installation technician



Do not place the electronic device in a room with an explosive atmosphere.

- Mount the electronic unit on a level wall at eye level.
- Check that the electronic unit is easily accessible and easy to monitor.
- Make sure the electronics unit is protected from water and splashes.
- Make sure the electronics unit is out of direct sunlight.

1. Unscrew the 4 plastic screws on the lid
2. Carefully loosen cable that runs between lid and bottom part
3. Hold the unit against the wall.
4. Mark out the four drill holes on the wall with a pencil.
5. Drill 4 holes in the wall.
6. Screw the unit to the wall.
7. Connect the inputs as described in the chapter “Electrical connection”.

5.1.2 Electrical connection



Risk of electric shock

- Disconnect the mains power supply before working on the unit and make sure that the unit cannot be switched on.

Note:

- Connect the electronic unit to AC power with a suitable, fixed installed cable 3 x 1.5 mm².
- Properly secure the power supply to the electronic unit (16A max.).
- Make sure that the partition between the terminals and other electronics is in place.

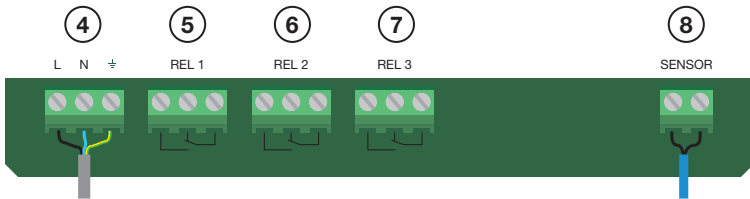
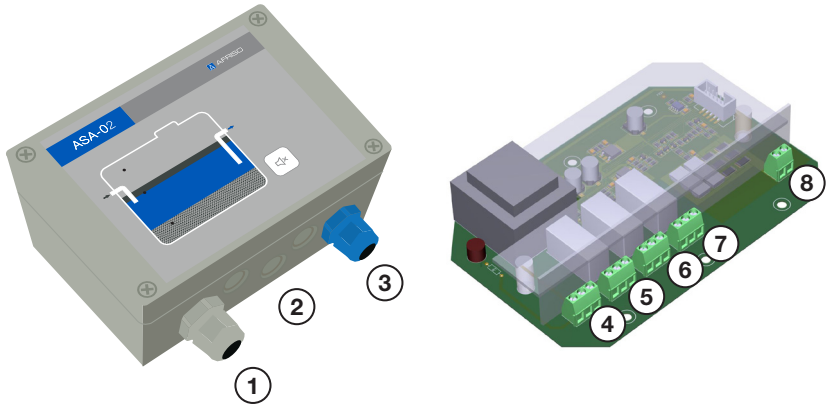

5.1.3 Connection overview

- 1 = Supply voltage cable gland - electric cable type 3 x 1.5 mm²
- 2 = 3 knock-outs for mounting cable glands (if relays are to be used)
- 3 = Cable gland for connection of probes cable – type 2 x 0.75 mm²
- 4 = Terminal for connecting 230 VAC
- 5 = Relay 1 terminal - Potential-free switch (symbol shown in alarm mode)
- 6 = Relay 2 terminal - Potential-free switch (symbol shown in alarm mode)
- 7 = Relay 3 terminal - Potential-free switch (symbol shown in alarm mode)
- 8 = Terminal for connecting probes cable from junction box ASA

5.2 Mounting the probes



Lay the cables within Ex area so they are mechanically protected



The probes may be installed in areas with an explosive atmosphere (Zone 0)

Note !

When installing the sludge probe, the installer must ensure that the probe has clear vision from its position, and down to the bottom of the separator. Check the drawing of the separator or feel with a stick or similar that nothing is in the way.

The illustration below is an example of how to mount the probes, but the exact appearance of the separator type will vary from one manufacturer to another. Check with your separator manufacturer for further details.

5.2.1 Suspending the probes

Layer probe ASA-LP (7) is mounted so that the entire probe is just below the static water level (3). The probe's bottom plug must be in water to NOT trigger an alarm. ASA-LP has a gray top and bottom plug.

High level probe ASA-HLP (6) is mounted so that its underside is located 300 mm above the top of the separator inlet pipe. The probe must be in air (2) to NOT trigger an alarm. ASA-HLP has a yellow top and bottom plug.

Mount the sludge probe ASA-SP (8) so that its underside is 600 mm above the actual bottom of the separator, or as an alternative 300 mm above the recommended sludge discharge height (5), specified in the separator manual. The ASA-SP has a blue top and bottom plug.

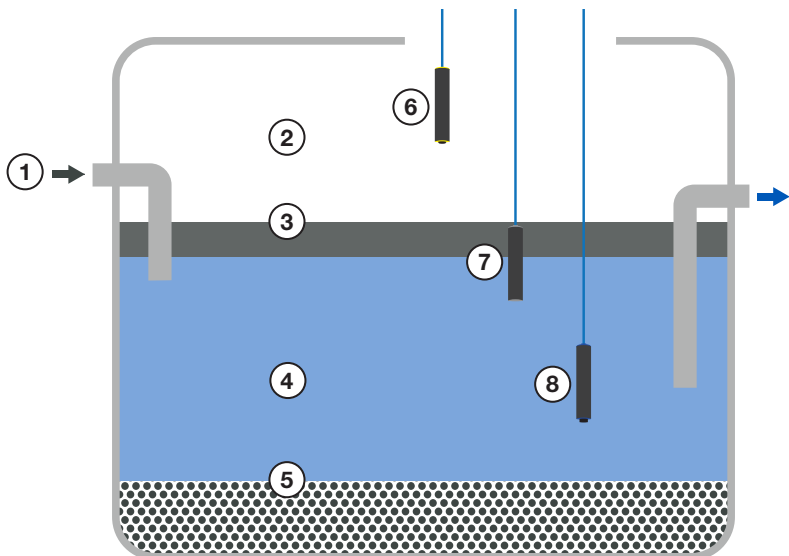

For the secure suspension of probes in separators, a stainless-steel probes bracket with a spring lock, plastic grommet and cable ties are included.

1. Screw the probes bracket into the appropriate position in the separator collar.
2. Immerse the probes in the separator so that it is positioned as recommended in the picture in this paragraph
3. Make a loop on the cable at the level of the probes bracket and insert the grommet into it. Finish by using cable ties to hold the loop together.
4. Hang the loop in the probes bracket, which now ensures that the probes is always in the same position.
5. Twist excess cable together in a ring and secure this with cable ties.
6. Then connect the probes cable to the junction box ASA.
7. Repeat the steps above if additional probes need to be installed.

It is important to leave enough cable to be able to lift up probes for cleaning and when it is time to empty the separator.

5.2.2 Electrical connection of the probes

It is advisable to use a 2 x 0.75 mm² cable between the electronic unit and the separator. Connect this cable in the separator to the junction box ASA, where the probes are also connected (see overview image under the item “Product description”).

4-way box for the connection of 1 to 3 probes

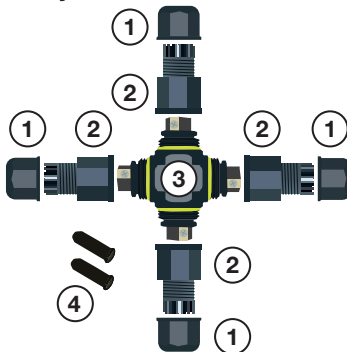

Product description

- 1** = Lock nut
- 2** = Cable bushing
- 3** = Switch cover
- 4** = End plug
(for sealing in cases where bushing is not used)

Connection

1. Unscrew locknut (1) and cable gland (2) from switch cover (3)
2. Thread the cable through the lock nut and cable gland
3. Peel off approx. 30 mm of the cable’s jacket and approx. 8 mm of the conductor’s insulation.
4. Connect the conductors to screws one and two (polarity independent)
5. Screw the cable gland and the switch cover together. Then tighten the locknut.

6 Commissioning

Note ! Make sure that the electronic unit and probes are installed according to the instructions in previous points.

Note ! The oil/grease detector will only trigger an alarm if there is a distinct layer differentiation has formed between the water and the oil/grease. The unit does not work in emulsion or where the grease or oil has been dissolved by chemicals.

Handling for start-up

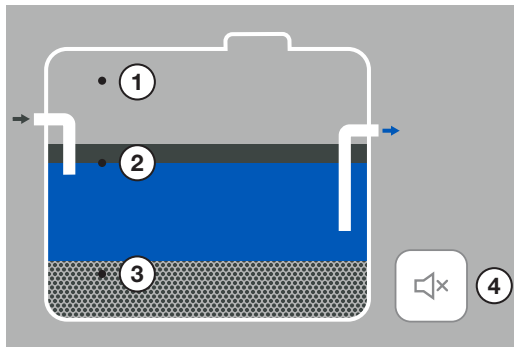

1 = Status diode for high level probe, ASA-HLP

2 = Status diode for layer probe, ASA-LP

3 = Status diode for sludge probe, ASA-SP

4 = Mute button

Buzzer

A built-in buzzer emits an audible alarm, but this can be silenced using the mute button.

The buzzer sound automatically reactivates after 20 hours if the alarm is still active.

Check the following before starting up the electronic unit

Make sure that all connections and installations are correctly done before connecting power.

- Turn on the power for the electronic unit

Start the automatic set-up function. The unit then does a probe input check and automatically registers connected probes.

When the unit is ready, the status diode of the respective probe lights up green.

The next step is to do a functional check as described in the Maintenance chapter.

7 Operation

After commissioning, check the function and, if no status diodes light up red, the separator alarm is ready for use. No special handling is required except that the unit must normally be energised to detect alarms from the probes. During normal operation, all status diodes with connected probes shine green.

7.1 Alarm

The status diodes are used to monitor the probes' status and are described below.

7.1.1 Layer alarm

The layer of oil/grease in the separator exceeds set alarm level. Status diode shines red, the buzzer sounds, and relay 1 changes status.

The alarm can be acknowledged by pressing the mute button for 1 second. If the alarm is still active after 20 hours, the alarm will be triggered again as described above.

7.1.2 High level alarm

The level of liquid in the separator has risen to the preset alarm level. The status diode shines red, the buzzer sounds and relay 2 changes status.

The alarm can be acknowledged by pressing the mute button for 1 second. If the alarm is still active after 20 hours, the alarm will be triggered again as described above.

7.1.3 Sludge alarm

The sludge level in the separator exceeds the alarm level. The status diode shines red, the buzzer sounds, and relay 3 changes status.

The alarm can be acknowledged by pressing the mute button for 1 second. If the alarm is still active after 20 hours, the alarm will be triggered again as described above.

7.1.4 Alarm probes error

A probes short-circuits or a cable is broken. The status diodes flash red and the buzzer sounds.

The alarm can be acknowledged by pressing the mute button for 1 second. If the alarm is still active after 20 hours, the buzzer will sound again.

8 Maintenance

Function test the separator alarms according to SS-EN 1825 and SS-EN 858, respectively.

For further details, see the separator's operating and maintenance instructions.

8.1 Function test

Before function testing, activate the unit's Test Mode so that alarms can be detected without delay/filtration.

Press and hold the MUTE button for 5 seconds. The status diodes illuminate one at a time and three times as confirmation. The unit will remain in Test Mode for 60 minutes, after which it automatically returns to normal operation. To return to normal operation before 60 minutes have passed, press and hold the MUTE button for 5 seconds.

- Lift the layer probe type ASA-LP out of the water to trigger an alarm.
- Lower the high-level probe type ASA-HLP to approach the surface to trigger an alarm.
- Lower the sludge probe type ASA-SP to approach the bottom of the separator to trigger an alarm.

The alarm can be acknowledged by pressing the mute button for 1 second. After resetting the probes to the correct height, the status diode will change from flashing red (alarm) to green (normal operation).

8.2 Probes maintenance

Probes may need to be wiped off at regular intervals, as coating may trigger alarms unnecessarily. If wiping is not sufficient, it is advisable to clean the unit with washing-up liquid and a brush.

8.3 Troubleshooting

Problem	Check	Cause/action
No status diodes illuminated	Make sure that the unit is energised	Unscrew the lid and measure on the terminal for the connection of 230 VAC. Also check the cable between the enclosure's electronics and the lid.
Layer alarm triggered	Check the thickness of the oil/grease layer	Order emptying
High level alarm triggered	Blockage at outlet to separator (critical alarm). Could also be condensation on the sensor.	Clear blockage or determine the cause, alternatively, wipe off condensation on the bottom part of the probe.
Sludge alarm triggered	The sludge level has reached the preset alarm level (normal alarm)	Normally this means that the sludge layer in the tank is too big, this normally causes that the efficiency of the separator is impaired. Emptying of separator should be ordered.
Short circuit or probe disconnection	Cable between electronics unit and probe is shorted or damaged	Check the cable
Probe error layer/high level/sludge	The probe cable is short-circuited, damaged or loose in the junction box	Check the connection in the junction box and then the probe cable

When the ASA electronic unit is connected to intrinsically safe circuits leading into an area with an explosive atmosphere, be extremely cautious when performing fault diagnostics.

The only live parts in the unit that may be touched (with a tool or instrument) are the intrinsically safe connection blocks' connections. Only measuring instruments that do not have a detrimental effect on the intrinsically safe characteristics may be used. EN 60079-17 must be adhered to during fault diagnostics/maintenance. If problems persist, contact the manufacturer.

9 Spare parts

Central unit, ASA-02

Electronic unit

Part no.: ASA-02

RSK no.: 5141014

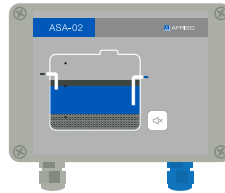

Layer probe, ASA-LP

Capacitive probe that triggers an alarm in the event of a thick layer of oil/grease in the separator.

5 metres of cable.

Part no.: ASA-LP

RSK no.: 5141025



High level probe, ASA-HLP

Ultrasonic probe that triggers a high-liquid level alarm in a separator.

5 metres of cable.

Part no.: ASA-HLP

RSK no.: 5141021



Sludge probe, ASA-SP

Ultrasonic probe that triggers an alarm when the level of sludge is high in a separator.

5 metres of cable.

Part no.: ASA-SP

RSK no.: 5141027



Junction box, ASA

For connection of 1-3 ASA probes

Part no.: 1207

RSK no.: 5141028



10 Technical data

10.1 Separator alarm, ASA-02

Specific terms of use:
Specifications under “Intrinsically Safe Parameters”, “Operating Voltage” and “Relay Outputs” must be followed

Intrinsically safe circuit is galvanically separate from earth.

Intrinsically Safe Execution	⊕ II (1) G [Ex ia Ga] IIA
Intrinsically safe parameters	Uo: 14.3 VDC, Io: 0.3 A, Po: 1.1 W, Co: 16 µF, Lo: 3.1 mH
Operating voltage	230 VAC, 50 Hz
Relay outputs, switch data	Um 250 VAC, Im 5 A, max 100 VA, potential free
Ambient temperature, electronics	-20 - +60°C
Enclosure	175 x 125 x 75 mm (W x H x D), 0.75 kg, ABS plastic, IP 65

Note ! : The above intrinsically safe parameters (Co and Lo) apply under the following conditions:

1. The combined concentrated inductance (Li) and capacitance (Ci) of the external intrinsically safe circuit does not exceed 1% of the above values
- or 2. Inductance and capacitance are distributed as in a cable
- or 3. The external intrinsically safe circuit does not contain either concentrated inductance on its own or concentrated capacitance in combination with a cable. In other cases involving combined concentrated capacitance (Ci) and concentrated inductance (Li) in the intrinsically safe circuit, up to 50% of the value of Lo is permitted and up to 1 µF.

10.2 Probes, ASA

Must be connected to barrier that is galvanically separate from earth.

Intrinsically safe execution	⊕ II 1 G Ex ia IIA T4 Ga
Intrinsically safe parameters	Ui: 14.3 VDC, Ii: 0.3 A, Pi: 1.1 W, Ci: 120 nF, Li: 0 µH
Ambient temperature probes	-20 - +40°C
Enclosure	150 mm, Ø30 mm, PEHD plastic, IP68
Cable	Oil resistant, 5 metres, 2 x 0.75 mm ²

11 Appendix

11.1 EU Declaration of Conformity (DoC)



EU Declaration of Conformity (DoC)

We

Afriso Ema AB
Kilvågen 2
232 37 Arlöv
Sweden

declare that this DoC is issued under our sole responsibility and belongs to the following product(s):

ASA-01, ASA-02, ASA-03, ASA-04, ASA-05 (Control units)
ASA-MLP, ASA-HLP, ASA-MSP, ASA-LP, ASA-SP (Probes)

to which this declaration relates is in conformity with the following standards and directives.

Directive		Harmonized Standard
Low Voltage Directive	2014/35/EU	EN IEC 61010-1 (2010)/A1(2019)
EMC Directive	2014/30/EU	EN IEC 61000-6-1 (2019) EN IEC 61000-6-3 (2021) EN IEC 61326-1 (2021) (ASA-MLP)
RED Directive	2014/53/EU	ETSI EN 300 328 v.2.2.2 (Parts of) ETSI EN 301 893 v.2.1.1 (Parts of) ETSI EN 301 908-1 v.13.1.1 (Parts of) ETSI EN 301 908-13 v.13.2.1 (Parts of) ETSI EN 303 413 v.1 (Parts of)
ATEX Directive	2014/34/EU	EN IEC 60079-0 (2018) EN 60079-11 (2012) EC Type examination certificate: DNV 23 ATEX 86944X Notified Body: DNV, Notified body number 2460

Signed for and on behalf of Afriso Ema AB

Date of issue: 2024-07-09

Signature of authorized person:



Jonas Ericson Nihlstopf, CEO

Notes



Afriso Ema AB

Kilvägen 2 • SE-232 37 Arlöv
Tel. +46 (0)40-92 20 50
info@afriso.se • www.afriso.se