

Uponor Ecoflex chamber

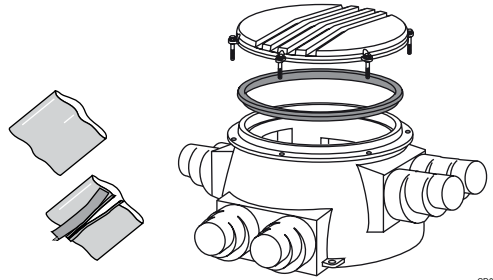

CD0000213

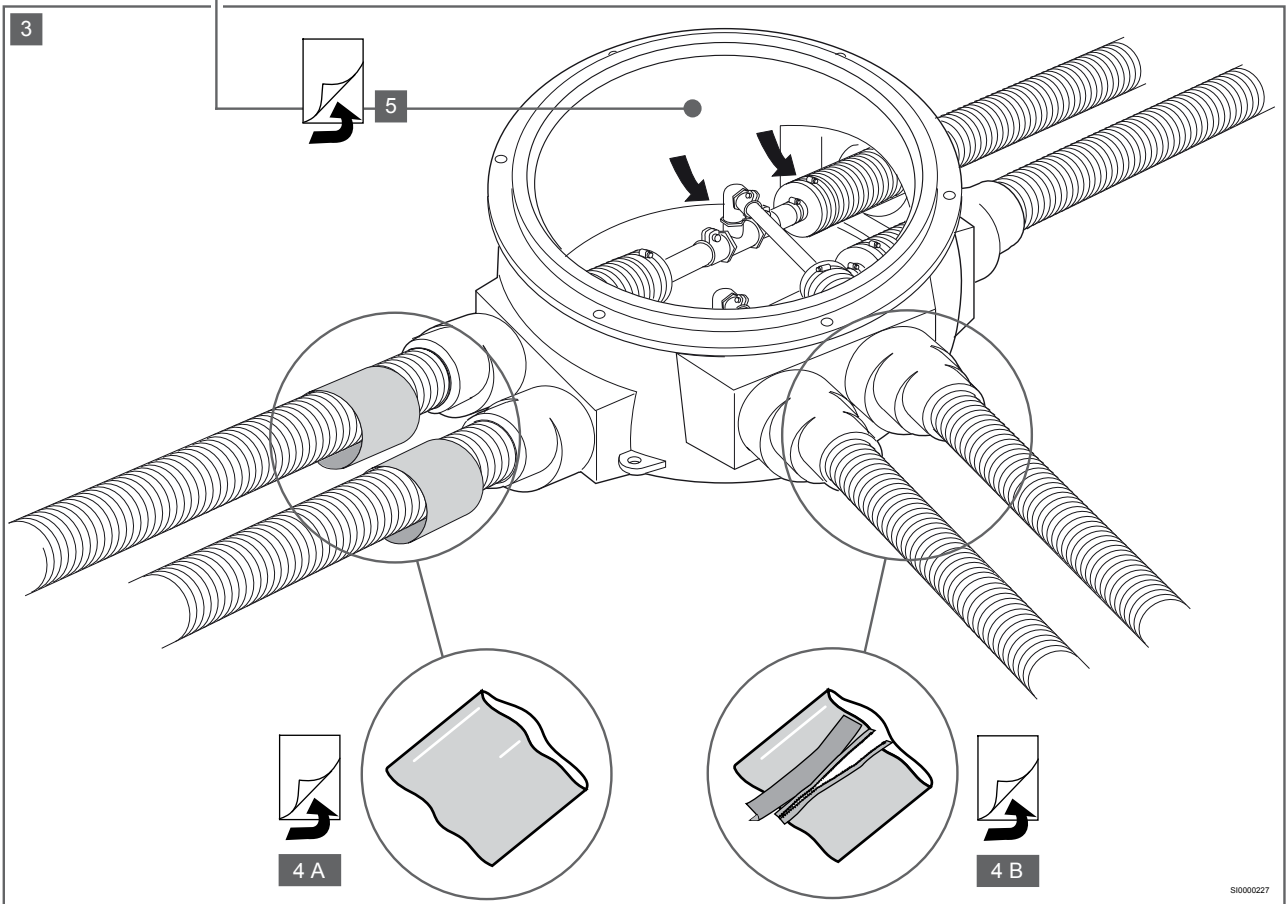
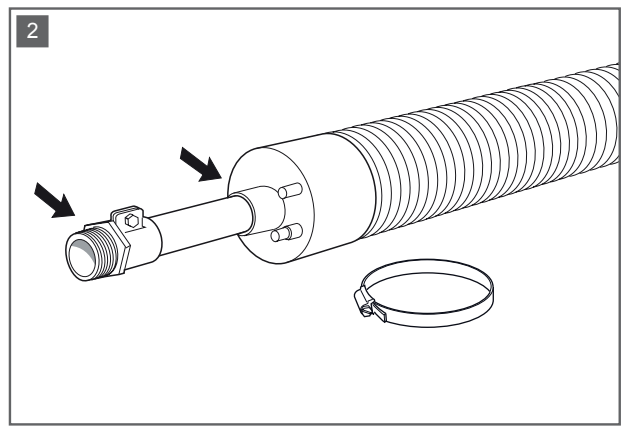
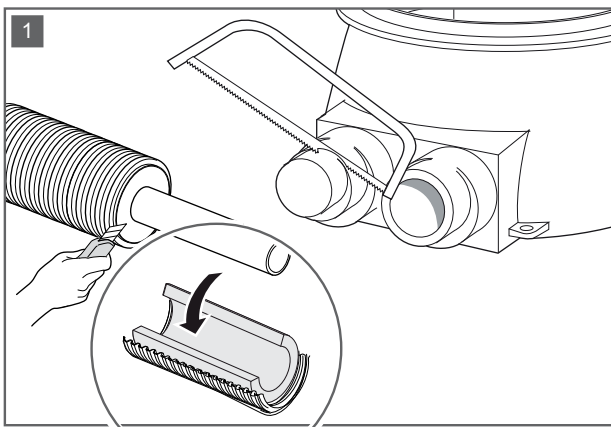

SI0000227

4 A

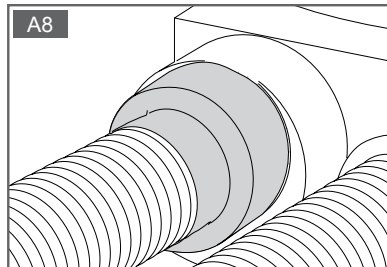
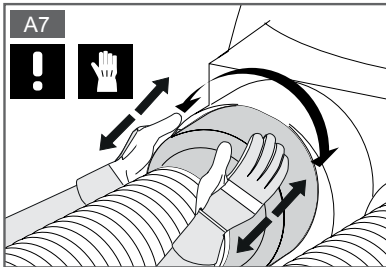
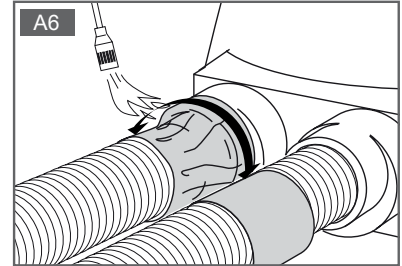
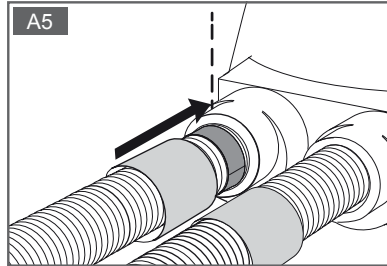
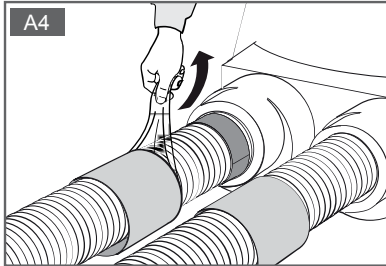
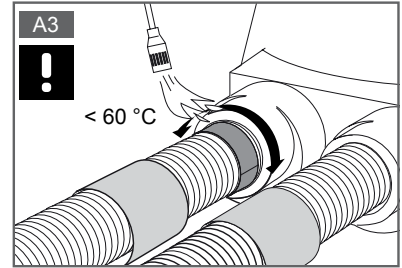
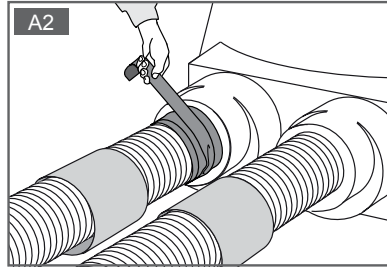
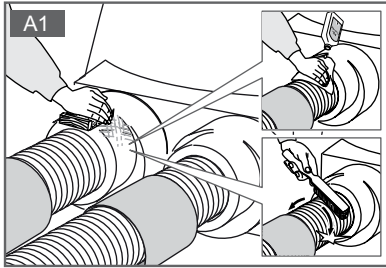

4 B

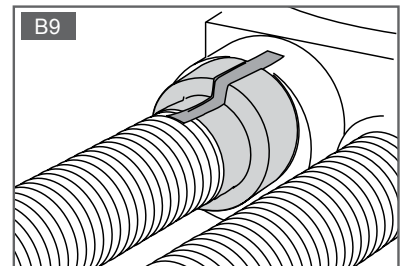
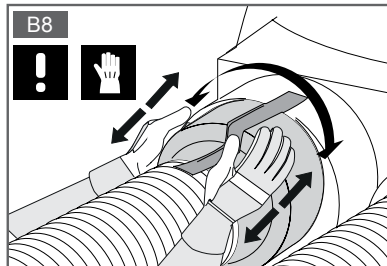
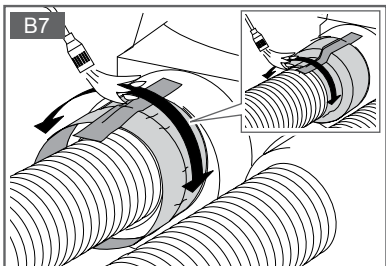
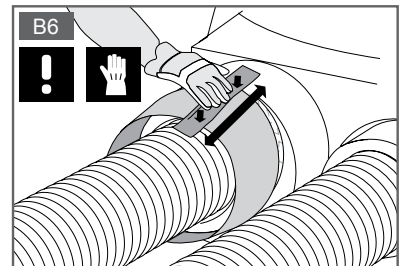
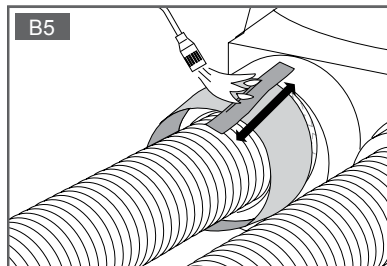
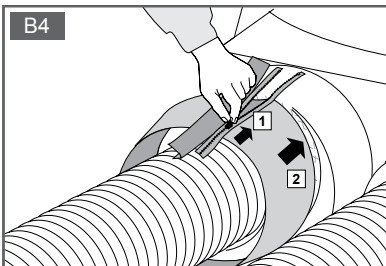
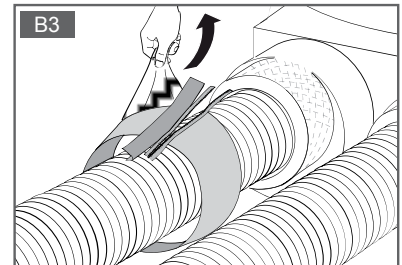
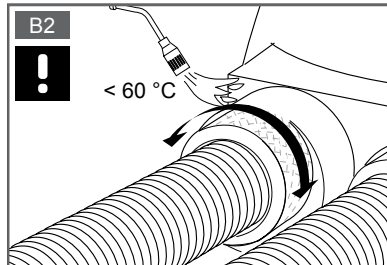
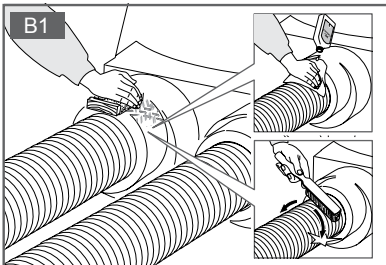

S10000228

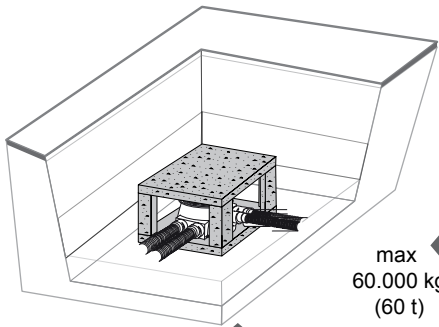
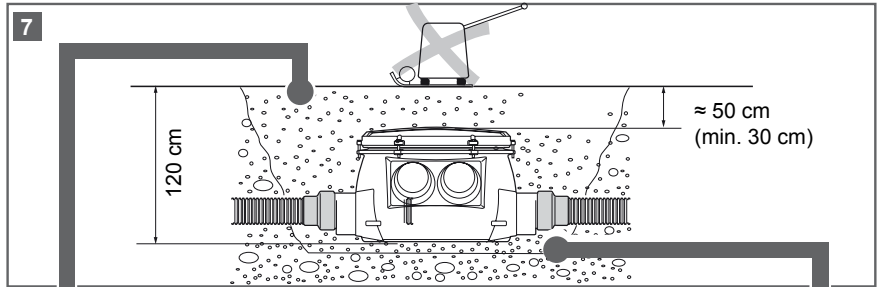
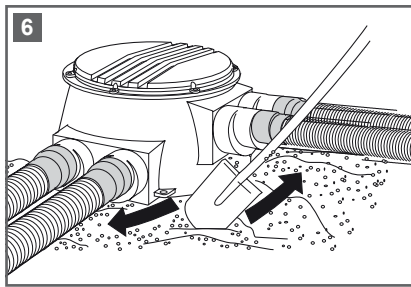
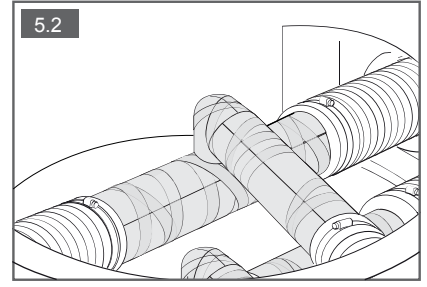
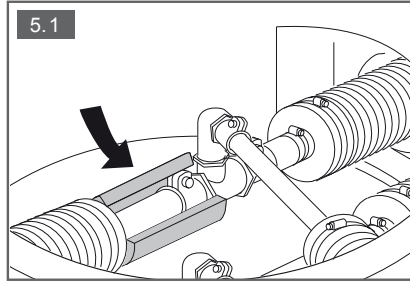
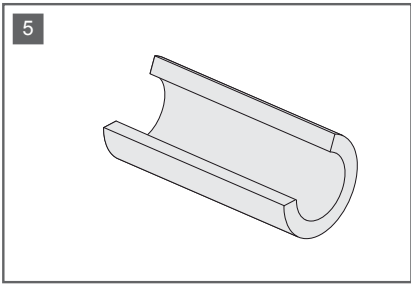

max
60.000 kg
(60 t)

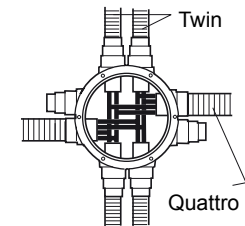
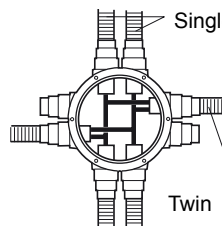
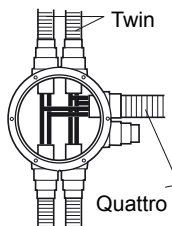
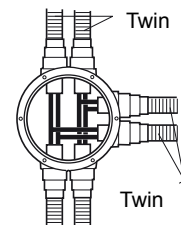
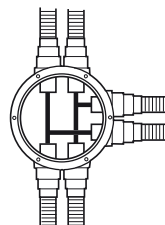
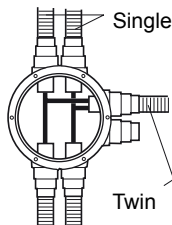
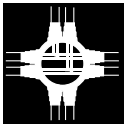
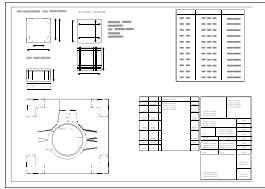
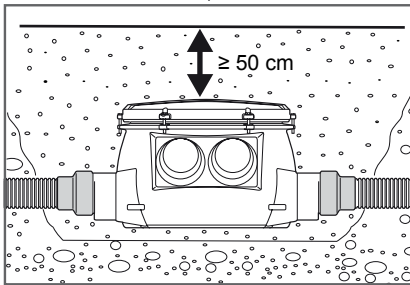
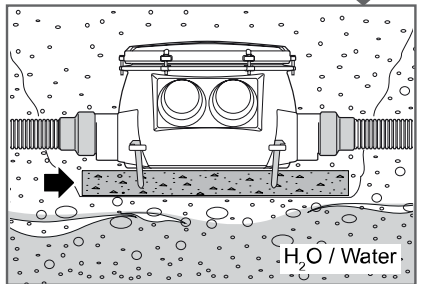
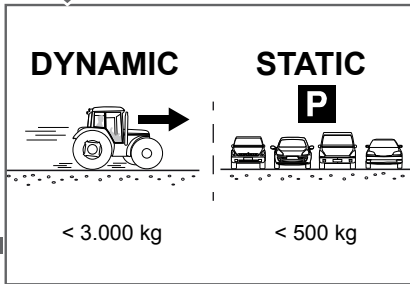

822000015



[mm]

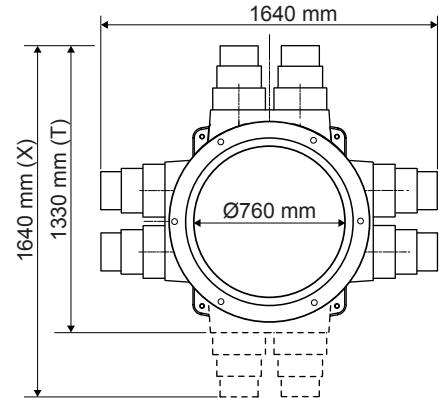
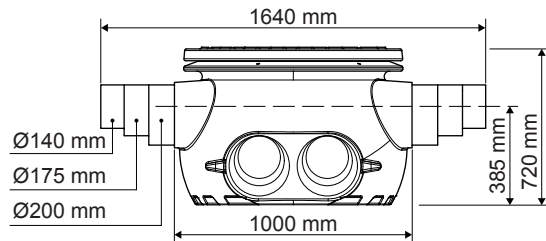
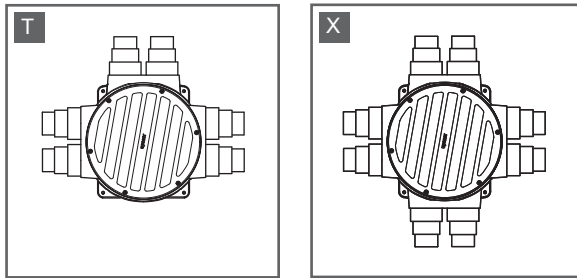

 IM Ecoflex 250mm jacket pipe connection to chamber  www.uponor.com/services/download-centre



[kg]

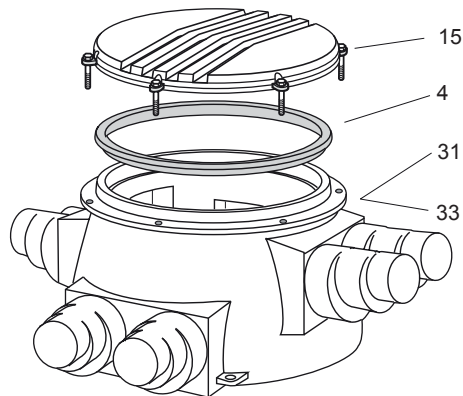

ALL PIPE SYSTEMS

Uponor Suomi Oy
Nastola - Forssa

ZD0000048

Uponor GmbH

Industriestraße 56,
D-97437 Hassfurt, Germany

1071353 v6_05_2026
GF / SKA

Uponor reserves the right to change the product portfolio and the related documentation without prior notification, in line with its policy of continuous improvement and development.



www.uponor.com