

Uponor Tecto TN/TL

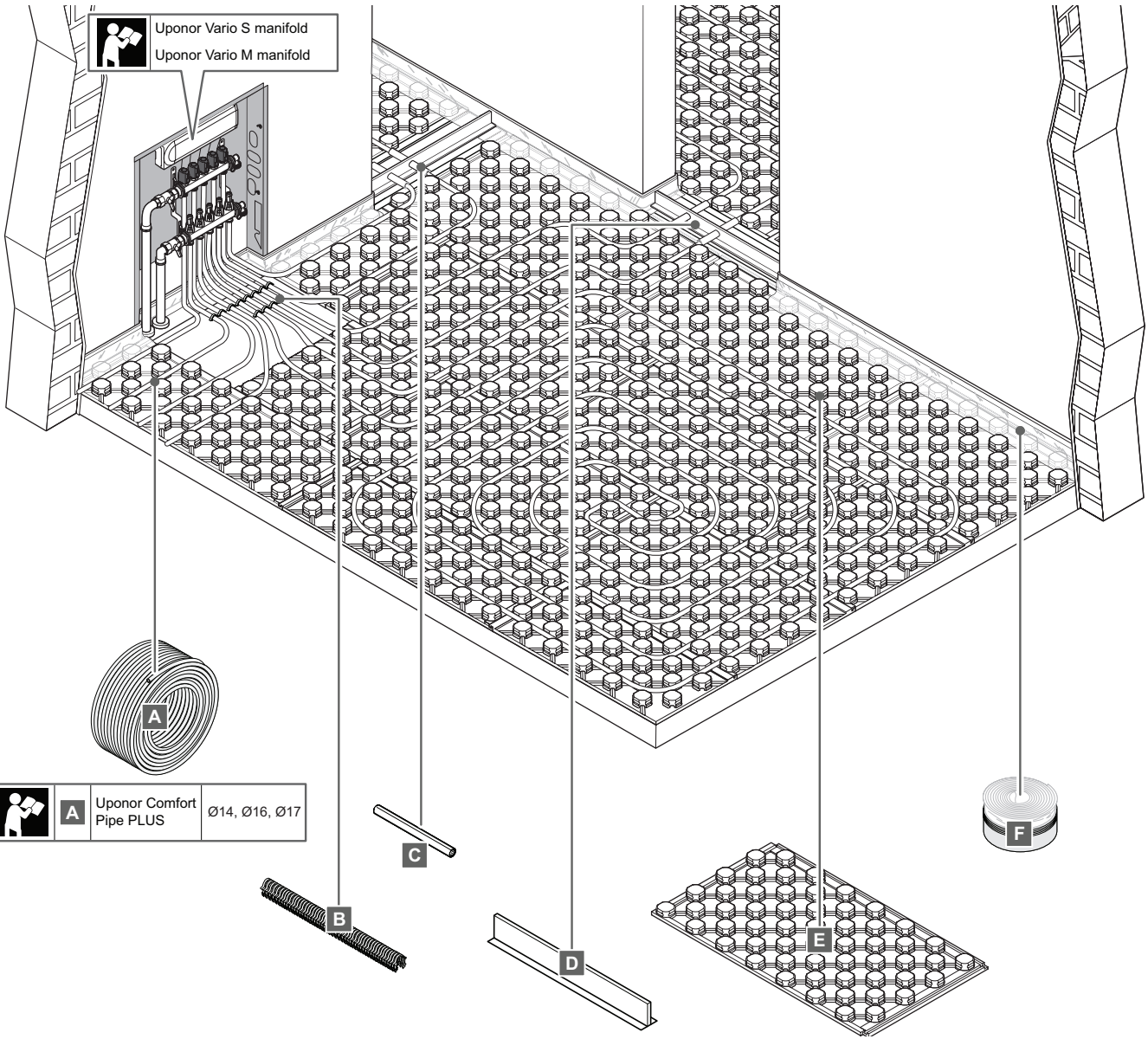

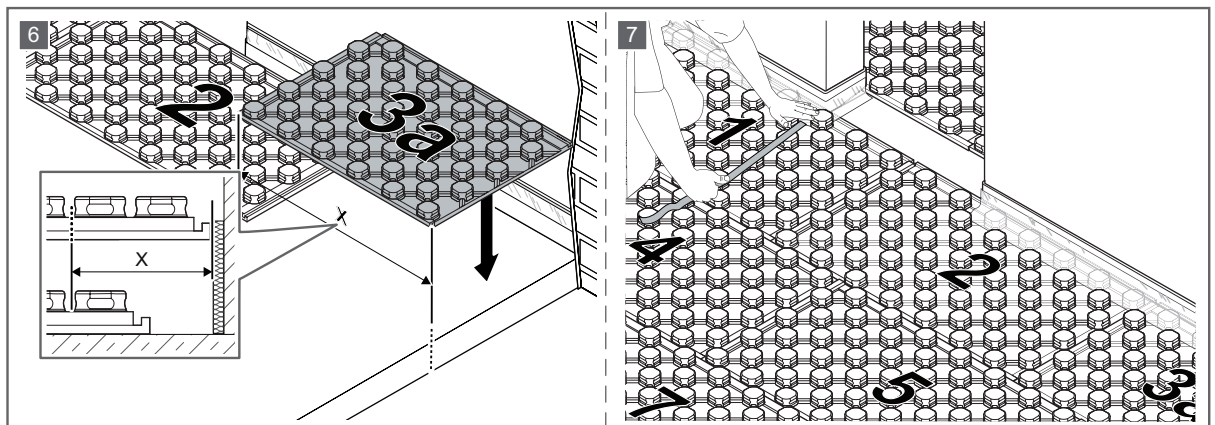

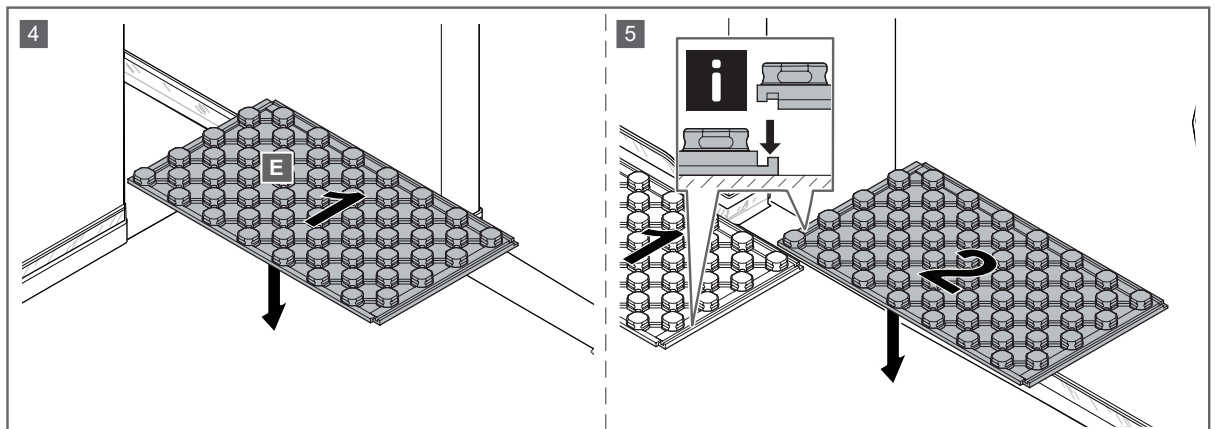
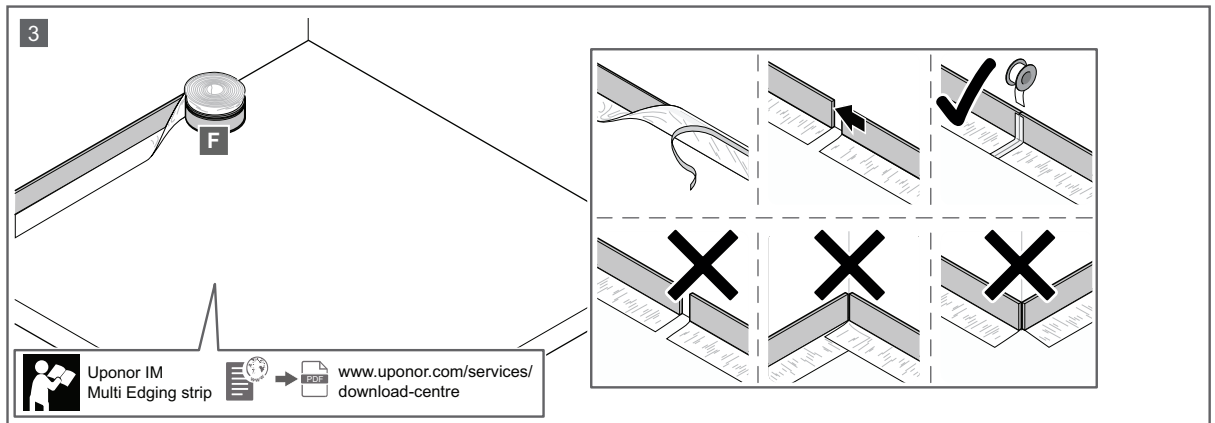
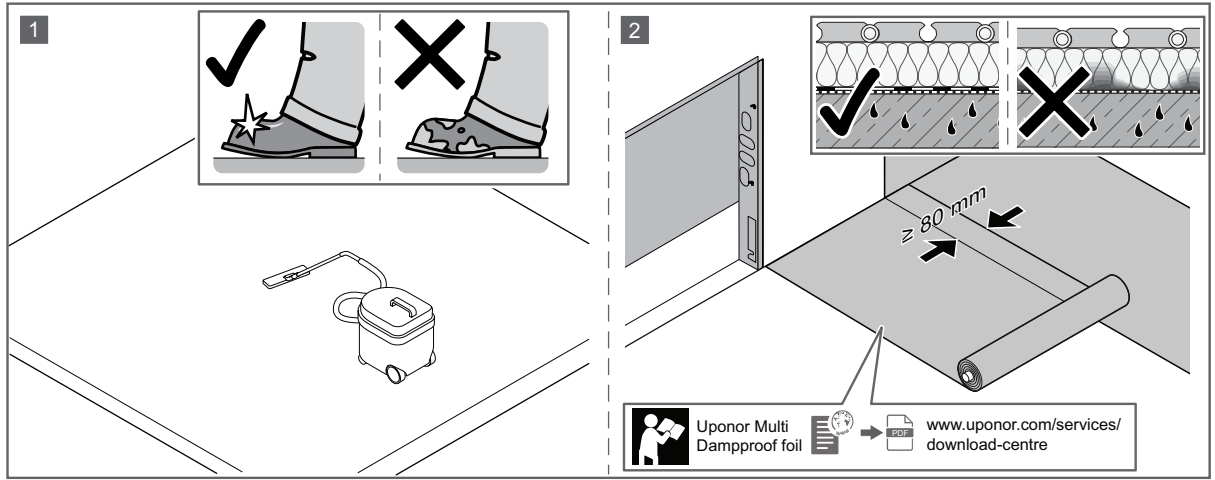
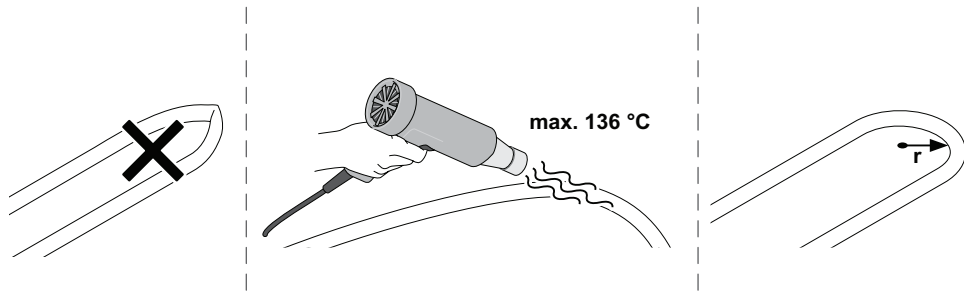
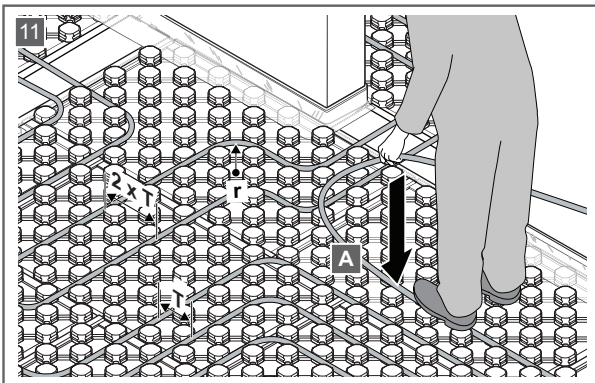
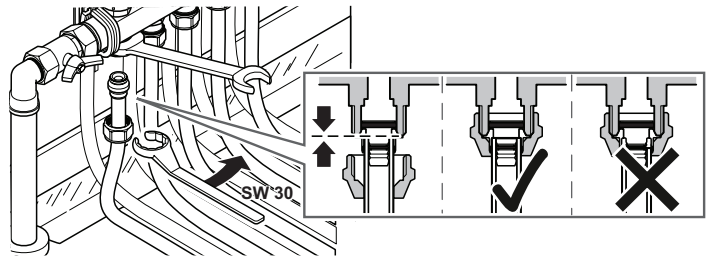
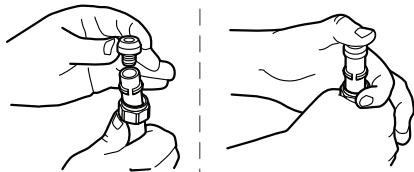
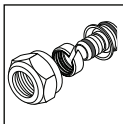
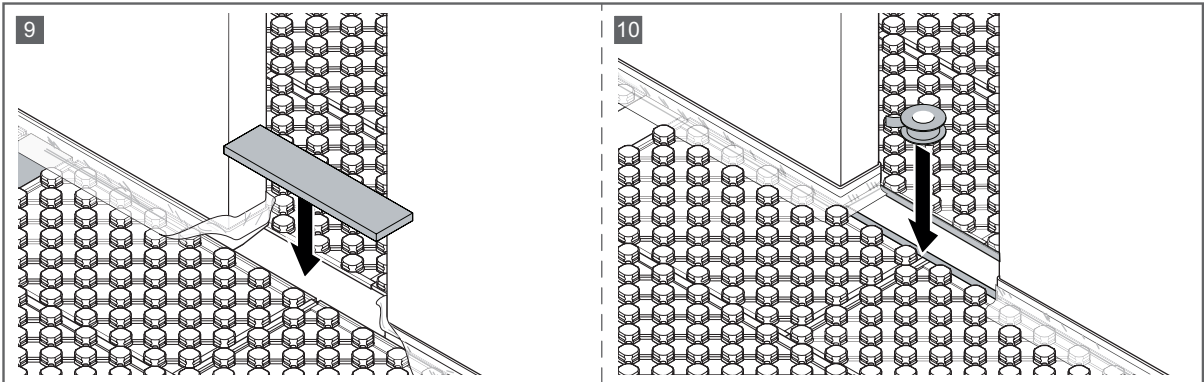
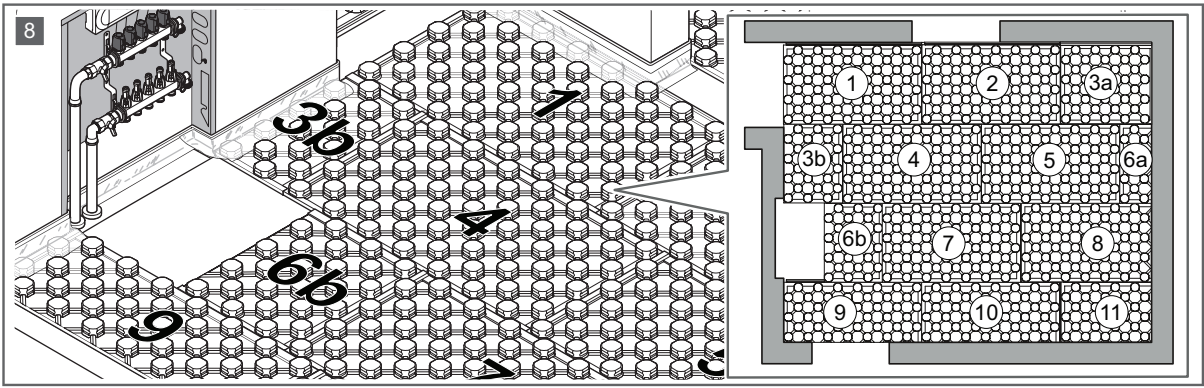

	Ø14	≥ 7,0 cm
A	Ø16	≥ 8,0 cm
	Ø17	≥ 8,5 cm

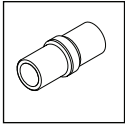

EN 1264

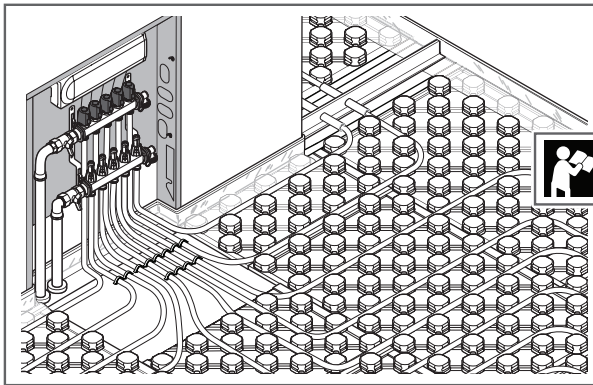
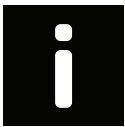
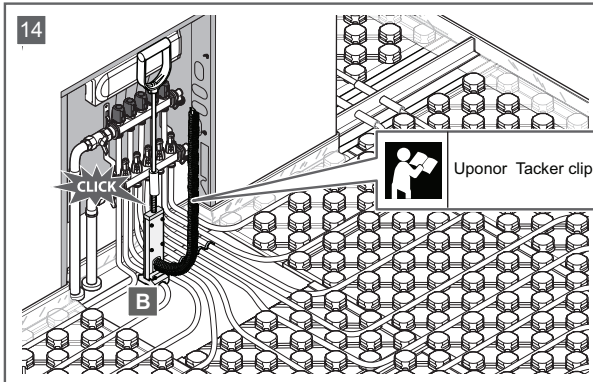
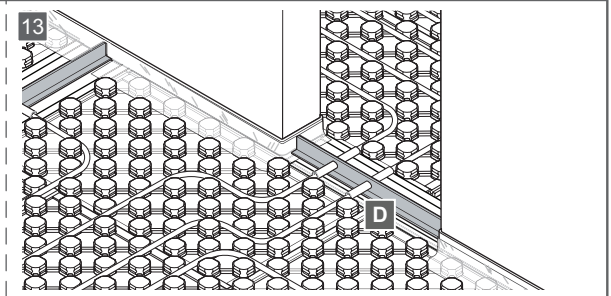
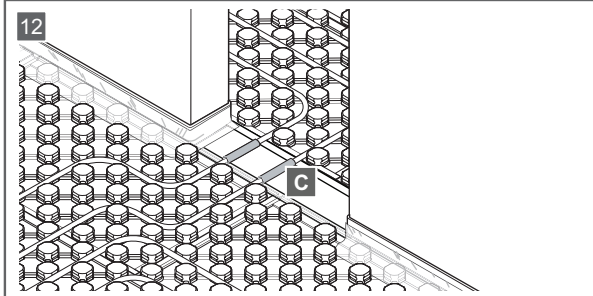
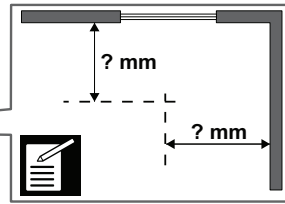
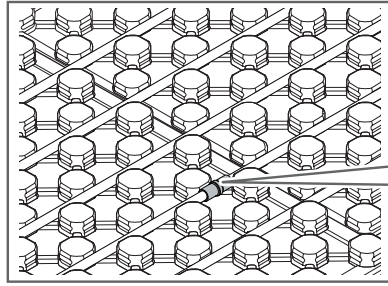

Uponor Vario S manifold
Uponor Vario M manifold



www.uponor.com/services/download-centre

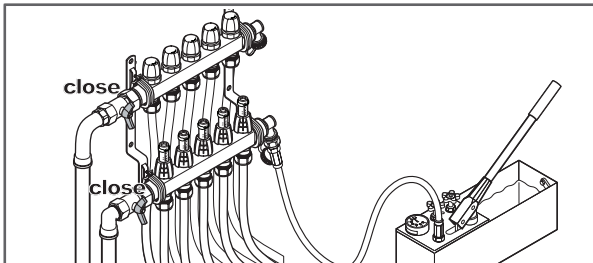

2 h



P = 4 – 6 bar

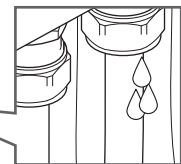

Uponor GmbH

Industriestraße 56,
D-97437 Hassfurt, Germany

1188264 v1_03_2026_TR
Production: GF / SKA

Uponor reserves the right to make changes, without prior notification, to the specification of incorporated components in line with its policy of continuous improvement and development.



www.uponor.com