

Combi Port / Aqua Port INS

EN Quick guide
DK Lynguide

ES Guía rápida
INT 

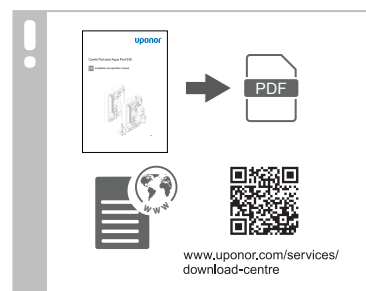
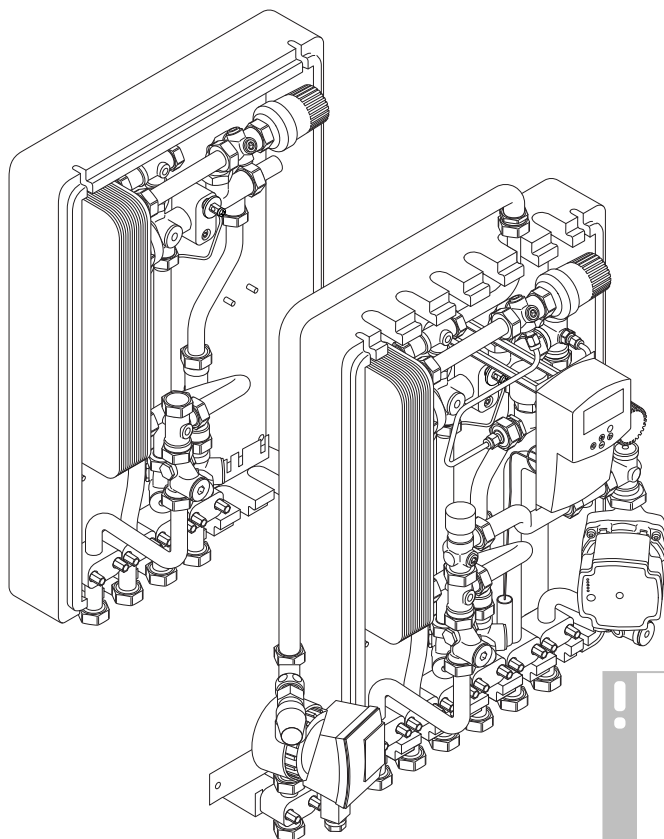



Table of contents

EN	3
1 Installation.....	3
DK	5
1 Installation.....	5
ES	7
1 Instalación.....	7
 INT	9







EN

DK

ES

1 Installation

1.1 General information

	Warning! Risk of electric shock if touching the components! The unit operates with a 230 V AC voltage.
	Warning! Risk of electrical shock! Electrical installation and service behind secured 230 V AC covers must be carried out under the supervision of a qualified electrician.
	Warning! The Uponor system uses 50 Hz, 230 V AC power. In case of emergency, immediately disconnect the power.
	Warning! Prior to any work on the controller or the components connected to it, switch off the controller according to the regulations.
	Warning! The fittings are under pressure. Escaping pressurized media can cause serious injury such as scalding or eye damage. Depressurise the system before performing any installation work. For retrofits to an existing system: Drain the system or close the supply lines of the section and depressurise it.
	Warning! Risk of injury due to the heavy weight of the unit. Do not perform the installation alone. Always wear safety shoes during the assembly. The unit can be of considerable weight, depending on the configuration. If the station falls over, this could lead to injuries, particularly to the feet.
	Caution! Leaks in the unit may occur during transport or installation. Check the nuts to ensure that they are properly tightened before the connection to avoid property damages.

Before installing the heat interface unit ensure that:

- the primary pipes are laid in the building site.
- the primary pipe installation is flushed and checked for leaks
- the power and ground cables are routed to the installation site.
- the unit is installed in a dry and frost-free room with an ambient temperature lower than +40 °C.
- the unit is mounted upright (not inclined, upside down or lying down).
- the unit is always easy to access even after the assembly.

Related illustrations



Illustrations related to the different sections below are available in the end of this document.

1.2 Heat interface unit

	Note See the dimensional drawings for measurements. All dimensions are given in mm.
---	---

1. Mark where to drill the holes.
2. Drill the holes.
3. Fix the HIU to the wall using the provided material.

1.3 Components

Strainer

	Caution! Lock the unit and relieve the pressure before any work with the strainer.
---	--

The strainer collects dirt and its filter can be removed for inspection and cleaning.

Heat meter distance piece

	Note The distance pieces are not suitable for continuous operation.
---	---

Heating pump

	Note It is recommended that the pump runs at constant pressure when used for underfloor heating. The factory setting of the pump is not set to constant pressure and must therefore be changed
---	--

The pump (Grundfos UPM3) has to be set to the constant pressure modus ($\Delta p-c$) to enable an optimal operation of the underfloor heating system.

The settings are done on the pump house as described in the installation and operation manual.

1.4 Hydraulic installation

	Warning!
	Leaking connections can cause personal injury and property damages.

	Note
	Install the pipes in accordance with planning documentation.

Connect the primary supply lines with the corresponding 3/4" ball valves at the HIU.

1. Check the settings.
2. Complete the acceptance/commissioning protocol.
3. Hand over the documentation and protocol to the homeowner.

1.5 Electrical installation

	Warning!
	Required electrical connections and installations, commissioning and maintenance must only be performed by an authorised person in accordance with local standards and regulations.

	Warning!
	Establish equipotential bonding by using a copper equipotential bonding conductor (cross-section at least 6 mm ²). Connect the earthing clamp to a suitable equipotential bonding rail in the building.

1.6 Filling and flushing

Fill and flush the system according to local regulations and standards.

1.7 Tightness testing

	Warning!
	Leaking connections can cause personal injury and property damages.

	Caution!
	Pressure leaks may occur even at normal operating pressure, and must be fixed immediately.

	Minimum 2 hours
---	-----------------

	According to local standards and regulations
---	--







1.8 Commissioning and hand over

	Caution!
	Improper commissioning can lead to property damage.

Complete commissioning by following these steps:

1 Installation

1.1 Generel information

	Advarsel! Risiko for elektrisk stød ved berøring af komponenterne! Enheden kører med en 230 V-vekselstrømspænding.
	Advarsel! Risiko for elektrisk stød! Elektrisk installation og service service bag sikrede 230 V vekselstrømsafskærmninger skal udføres af en autoriseret elektriker.
	Advarsel! Uponor-systemet bruger 50 Hz, 230 V vekselspænding. Afbryd omgående strømmen i nødstilfælde.
	Advarsel! Forud for alt arbejde på kontrolenheden eller de komponenter, der er tilsluttet den, skal kontrolenheden slukkes i henhold til bestemmelserne.
	Advarsel! Fittings er under tryk. Udslip af trykmedier kan forårsage alvorlig personskade som skoldning eller øjenskade. Udlign trykket i systemet inden installationen udføres. Ved efterinstallation på et eksisterende system: Tøm systemet, eller luk for sektionens forsyningsledninger, og udlign trykket.
	Advarsel! Risiko for personskade på grund af enhedens tunge vægt: Udfør ikke installationen alene. Bær altid sikkerhedssko under monteringen. Unitten kan have en betydelig vægt afhængigt af konfigurationen. Hvis installationskabet vælter, kan det medføre personskade, særligt beskadigelse af fødderne.
	Forsigtig! Lækager kan forekomme i enheden under transport eller installation. Kontroller omløbere for at sikre, at de er spændt ordentligt inden den forbindes for at undgå materielle skader.

Inden installation af varmeunitten skal det sikres, at:

- de primære rør er installeret på byggepladsen.
- den primære rørintallation er skyllet igennem og kontrolleret for lækager
- strøm- og jordkablerne er først til installationsstedet.
- enheden installeres i et tørt og frostfrit rum med en omgivelsestemperatur på mindre end +40 °C.
- unitten er monteret lodret (ikke skråt, på hovedet eller liggende).
- unitten altid er let tilgængelig, selv efter samlingen.

Relaterede illustrationer



Illustrationer relateret til de forskellige afsnit nedenfor er tilgængelige i slutningen af dette dokument.

1.2 Varmebetjeningsenheden

	BEMÆRK! Se måltetegninger for målinger. Alle mål er angivet i mm.
---	---

1. Markér, hvor hullerne skal bores.
2. Bor hullerne.
3. Fastgør unitten til væggen ved hjælp af de medfølgende skruer.

1.3 Komponenter

Si

	Forsigtig! Afbryd enheden, og let trykket, inden du arbejder med snavssamleren.
---	---

Sien opsamler snavs, og dens filter kan tages ud, så det kan undersøges og rengøres.

Måler pasrør til varmemåler

	BEMÆRK! Pasrøret er ikke egnede til kontinuerlig drift.
---	---

Cirkulationspumpe varme

	BEMÆRK! Det anbefales, at pumpen kører ved konstant tryk, når den bruges til gulvvarme. Pumpens fabriksindstilling er ikke indstillet til konstant tryk og skal derfor ændres
---	---

Pumpen (Grundfos UPM3) skal indstilles til konstant trykmodus ($\Delta p-c$) for at muliggøre optimal drift af gulvvarmesystemet.

Indstillingerne udføres på pumpehuset som beskrevet i installations- og betjeningsvejledningen.

1.4 Hydraulisk installation

	Advarsel! Utætte samlinger kan forårsage personskade og materielle skader.
---	--

	BEMÆRK! Installer rørene i henhold til planlægningsdokumentationen.
---	---

Tilslut de primære forsyningsledninger til de tilsvarende 3/4" kugleventiler på unitten.

1. Kontroller indstillingerne.
2. Udfyld indreguleringsrapporten.
3. Overlever dokumentation og indreguleringsrapport til slutbrugeren.

1.5 Elektrisk installation

	Advarsel! Krævede elektriske forbindelser og installationer, idriftsættelse og vedligeholdelse må kun udføres af en autoriseret person i henhold til lokale standarder og bestemmelser.
---	---

	Advarsel! Etabler potentialudligning ved hjælp af en potentialudligningsleder i kobber (tværsnit på mindst 6 mm ²). Tilslut jordklemmen til en passende potentialudligningsskinne i bygningen.
---	--

1.6 Påfyldning og gennemskyling

Påfyld og gennemskyl systemet ifølge lokale regulativer og standarder.

1.7 Tæthedstest

	Advarsel! Utætte samlinger kan forårsage personskade og materielle skader.
---	--

	Forsigtig! Lækage kan opstå selv ved normal driftryk, og skal repareres hurtigst muligt.
---	--



Minimum 2 timer



I henhold til lokale regler og standarder







1.8 Idriftsættelse og overdragelse

	Forsigtig! Forkert idriftsættelse kan føre til materielle skader.
---	---

Gennemfør idriftsættelsen ved at følge disse trin:

1 Instalación

1.1 Información general

	Advertencia: ¡Riesgo de descarga eléctrica por contacto directo! La unidad funciona con una tensión de 230 V de AC.
	Advertencia: Riesgo de descarga eléctrica. La instalación y el mantenimiento eléctrico de elementos protegidos con tapas y que funcionen a 230 V CA se debe llevar a cabo bajo la supervisión de un electricista cualificado.
	Advertencia: El sistema de Uponor utiliza alimentación 50 Hz, 230 V CA. En caso de emergencia, desconecte inmediatamente la alimentación.
	Advertencia: Antes de cualquier trabajo en la unidad o en los componentes conectados a ella, desconecte la unidad de acuerdo con la normativa.
	Advertencia: Los accesorios están bajo presión. El escape a presión puede provocar lesiones graves, como quemaduras o daños en los ojos. Quite presión en el sistema antes de realizar cualquier trabajo de instalación. Para actualizaciones en un sistema existente: Vacíe el circuito, cierre líneas de suministro y quite presión.
	Advertencia: Riesgo de lesiones debido al peso elevado de la unidad: No realice la instalación solo. Use siempre zapatos de seguridad durante el montaje. La unidad puede tener un peso considerable, dependiendo de la configuración. Si la estación se cae, esto podría conllevar lesiones, particularmente en los pies.
	Precaución: Pueden producirse fugas en la unidad durante el transporte o la instalación. Verifique las tuercas para asegurarse de que estén bien apretadas antes de la conexión para evitar daños a la propiedad.

Antes de instalar la unidad Combi Port, asegúrese que:

- Las tuberías están instaladas en la obra.
- La instalación de las tuberías están limpias y no hay fugas.
- Los cables suministro eléctrico y de toma tierra se tienden hasta el lugar de instalación.
- La unidad está instalada en una habitación seca y a salvo de heladas con una temperatura ambiente inferior a +40 °C.
- La unidad está montada en posición vertical (no inclinada, boca abajo ni de lado).

- La unidad presenta un fácil acceso, incluso después del montaje.

Iconografía



Existen iconos relacionados con las diferentes secciones al final de este documento.

1.2 Estación de transferencia de calor



NOTA:

Vea las dimensiones en los dibujos. Todas las medidas están en milímetros.

1. Marque dónde perforar los agujeros.
2. Taladre los agujeros.
3. Fije la estación HIU a la pared con el material proporcionado.

1.3 Componentes

Filtro



Precaución:

Bloquee la unidad y quite presión antes de realizar cualquier trabajo en el filtro.

El filtro retiene las posibles impurezas del agua, puede ser extraído para su inspección y limpieza.

Distanciador para contador de energía.



NOTA:

Las piezas distanciadoras no son adecuadas para un funcionamiento continuo.

Bomba de calefacción





NOTA:

Se recomienda que la bomba funcione a presión constante cuando se utiliza para calefacción por suelo radiante. El ajuste de fábrica de la bomba no está ajustado a presión constante y, por lo tanto, debe cambiarse.

La bomba (Grundfos UPM3) debe ajustarse al modo de presión constante ($\Delta p-c$) para permitir un funcionamiento óptimo del sistema de calefacción por suelo radiante.



Los ajustes de la bomba están descritos en el manual de instalación y funcionamiento.

1.4 Instalación hidráulica.

	Advertencia: Las conexiones con fugas pueden causar lesiones personales y daños a la propiedad.
	NOTA: Instale las tuberías de acuerdo con la documentación del proyecto.

Conecte las líneas de suministro principal con las correspondientes válvulas de bola de 3/4" en la estación HIU.



1.5 Instalación eléctrica

	Advertencia: Las conexiones e instalaciones eléctricas obligatorias, la puesta en servicio y el mantenimiento deben ser realizados únicamente por una persona autorizada de acuerdo con las normas y la legislación local.
	Advertencia: Establezca la conexión equipotencial utilizando un conductor de conexión equipotencial de cobre (sección transversal de 6 mm ² como mínimo). Conecte la pinza de toma de tierra a un rail de conexión equipotencial adecuado en el edificio.

1.6 Llenado y purgado

El llenado y purgado debe realizarse conforme a la normativa local.

1.7 Prueba de estanqueidad

	Advertencia: Las conexiones con fugas pueden causar lesiones personales y daños a la propiedad.
	Precaución: Pueden existir fugas incluso con una presión nominal, las cuales deben repararse inmediatamente.



Mínimo 2 horas.



Conforme a la normativa local.

1.8 Puesta en marcha

	Precaución: Una puesta en marcha y revisión incorrecta puede causar daños a la propiedad.
---	---

Una completa puesta en marcha debe incluir los siguientes pasos:

1. Revisar los ajustes.
2. Completar los protocolos de puesta en marcha y documentarlos.
3. Entregar la documentación y el protocolo de puesta en marcha a la propiedad.



1.2

S10000335

Uponor Aqua Port INS

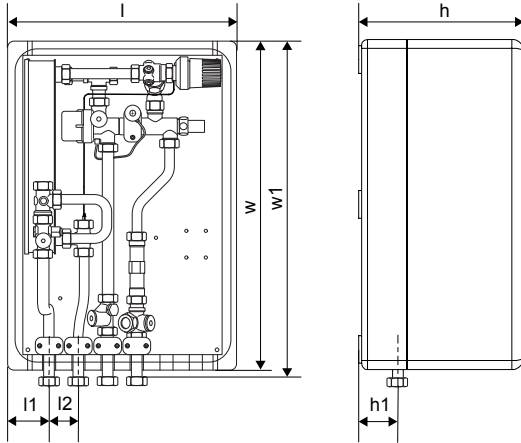

ZD0000072

l	l1	l2	w	w1
390 mm	70 mm	50 mm	560 mm	578 mm
h	h1			
280 mm	67 mm			

l	l1	l2	w	w1
390 mm	70 mm	50 mm	560 mm	578 mm
h	h1			
280 mm	67 mm			

Uponor Combi Port INS UFH with circulation and Uponor Smatrix

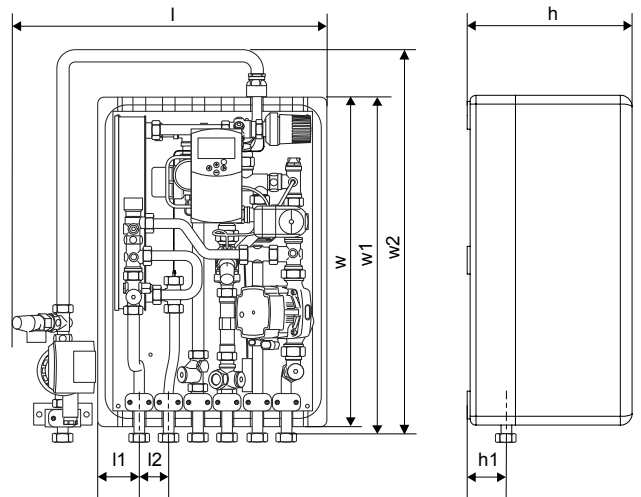

ZD0000070

l	l1	l2	w	w1
430 mm	70 mm	50 mm	560 mm	578 mm
w2	h	h1		
678 mm	280 mm	67 mm		

Uponor Combi Port INS

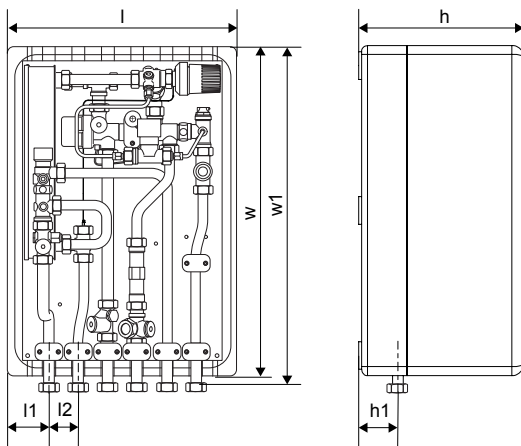

ZD0000071



1.2

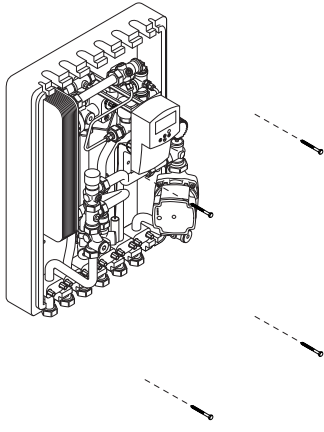

1.3 A

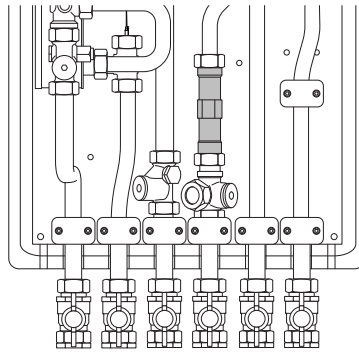

1.3 B

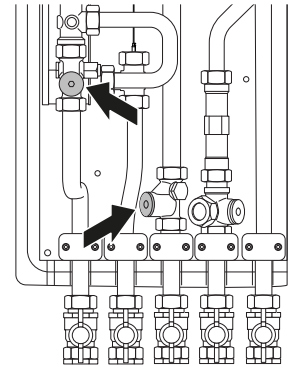

1.4

Uponor Combi Port INS UFH

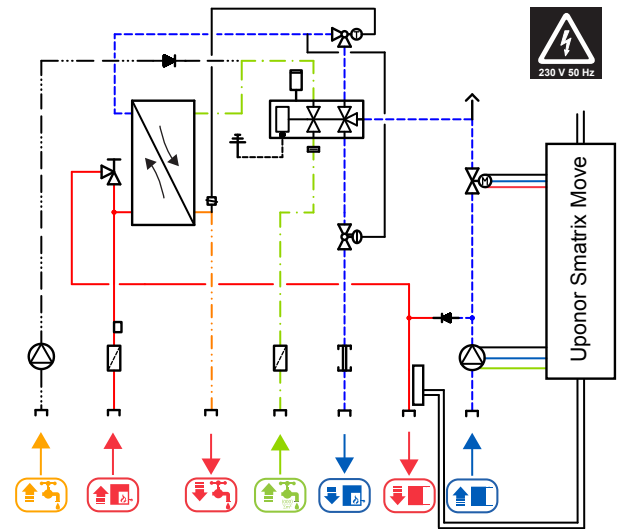
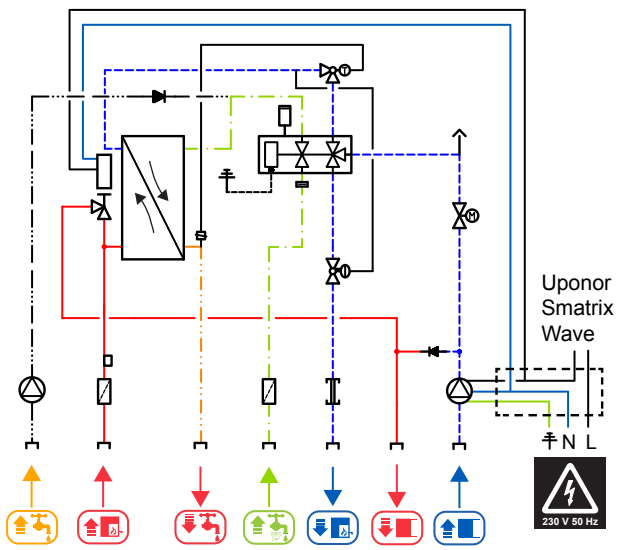

SI0000487

Uponor

Uponor GmbH

Industriestraße 56,
D-97437 Hassfurt, Germany

1121290 v1_09_2021_INT
Production: Uponor/DCO

Uponor reserves the right to make changes, without prior notification,
to the specification of incorporated components in line with its policy of
continuous improvement and development.



www.uponor.com