

Uponor Siccus Mini underfloor heating and cooling system

EN Technical information

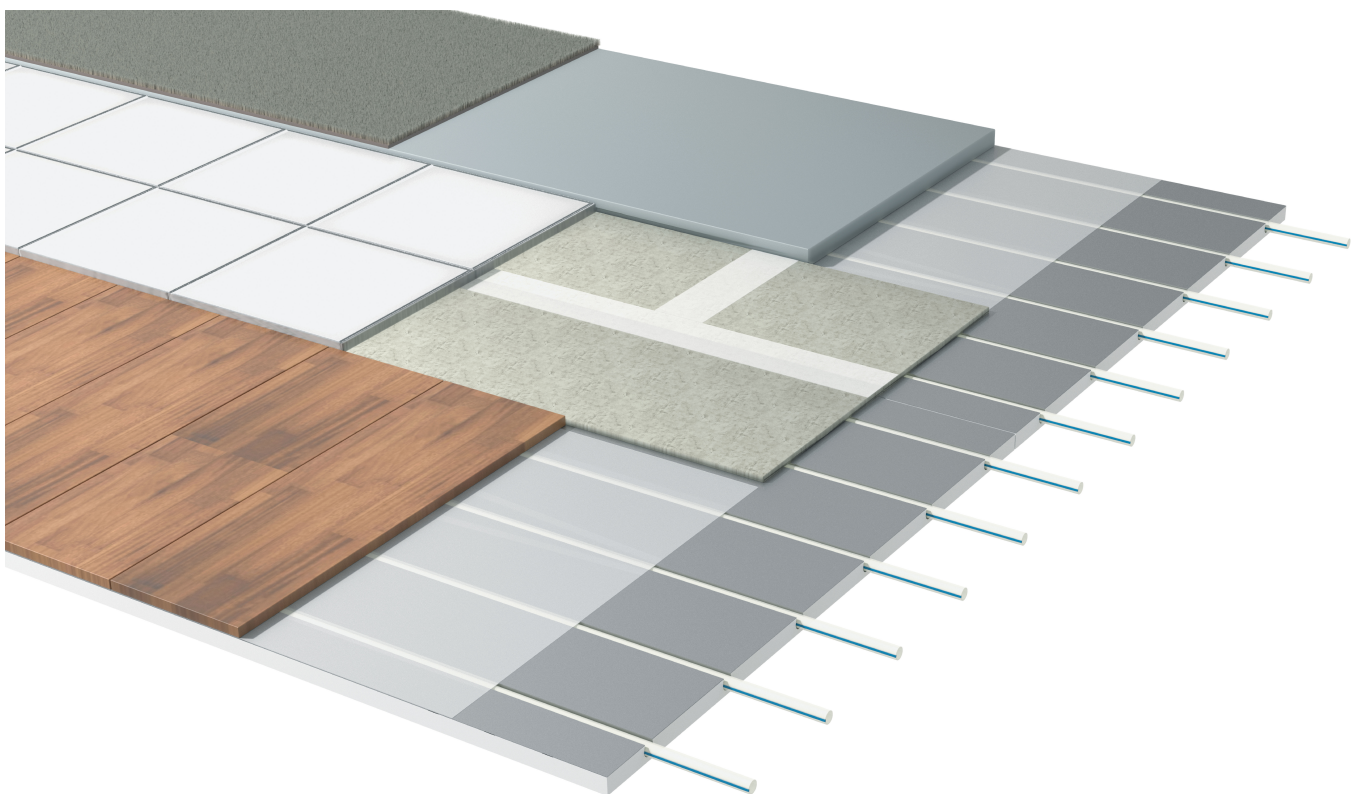

Table of contents

1	System description.....	3
1.1	Benefits.....	3
1.2	Components.....	3
1.3	Copyright and disclaimer.....	4
2	Planning/design.....	5
2.1	Floor constructions.....	5
2.2	Live loads for floor constructions.....	6
2.3	Dimensioning diagrams.....	6
2.4	Pressure drop diagram for Uponor Minitec Comfort Pipe 9,9 x 1,1 mm.....	10
2.5	Flooring materials.....	10
3	Installation.....	12
3.1	Installation process.....	12
4	Technical data.....	13
4.1	Technical specifications.....	13

1 System description



The Uponor Siccus Mini is a dry underfloor heating and cooling system suitable for modernising residential buildings. The system offers low-height floor construction by providing complete underfloor heating with a minimum number of components and can be used on different subfloors.

Uponor Siccus Mini is a combination of low height underfloor heating and cooling panel and Uponor Minitec Comfort Pipe 9,9 mm (PE-Xa pipes). This system enables direct flooring without screed for parquet and laminate and with an additional thin load distribution layer also for tiles, natural stone and soft floorings such as carpets and vinyl.

1.1 Benefits

- **One step-ready installation:** prefabricated XPS panel with full-surface aluminium heat diffusor
- **Low temperature:** heat pump renovation fit
- **Quick and dry:** no water, no drying time for parquet and laminate flooring
- **Comfort:** short heat-up times and fast response controls
- **Suitable:** low-height floor construction
- **Reliable:** long-lifetime proven technology

1.2 Components



Note

For more detailed information, product range and documentation please visit the Uponor website: www.uponor.com.



Note

For detailed information about the product range, dimensions and availability, please refer to the Uponor price list.

Uponor Siccus Mini panel

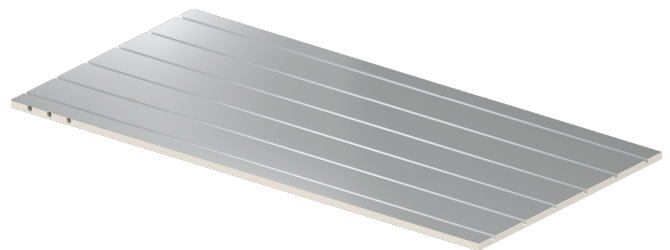

RP0000313

The Uponor Siccus Mini panel is an XPS panel grade 400kpa with dimensions 1200 x 600 x 15 mm and can be installed on top of the existing floor. The prefabricated panel is integrated with pipe grooves with a fixed pipe spacing of 100 mm.

The prefabricated aluminium foil of thickness 0,1 mm applied on top of the panel ensures a uniform heat distribution. The panel does not require an additional heat emission plate.

A live load up to 2 kN/m² or a point load up to 2 kN can use this panel.

Uponor Siccus Mini tile-backer panel



RP0000314

The Uponor Siccus Mini tile-backer panel is a synthetic panel with dimensions 1000 x 600 x 6 mm and it must be installed on top of the existing panel as a load distribution layer for tiles and natural stone.

A tile thickness of min. 8 mm carries a live load up to 1 kN/m² or a point load up to 1 kN and a tile thickness of ≥ 10 mm carries a live load up to 2 kN/m² or a point load up to 2 kN can use this panel.

Uponor Siccus Mini edging strip

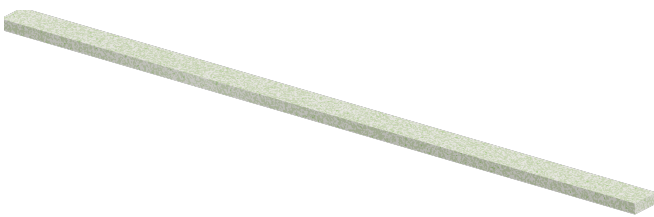

RP0000315

Uponor Siccus Mini edging strip is a synthetic strip with dimensions 1000 x 45 x 15 mm and is ideal for installing on the wall sides and in doorways. The strip is only used for tiles or natural stone installations, not for direct parquet or laminate installations.

Uponor Minitec Comfort Pipe



RP0000123

Uponor Minitec Comfort Pipe is a highly flexible PE-Xa pipe in dimension 9,9 x 1,1 mm.

The pipe fulfils the requirements for oxygen diffusion tightness as per DIN 4726.

Uponor jointing technology



Note

Only use fittings recommended by Uponor or its representatives.

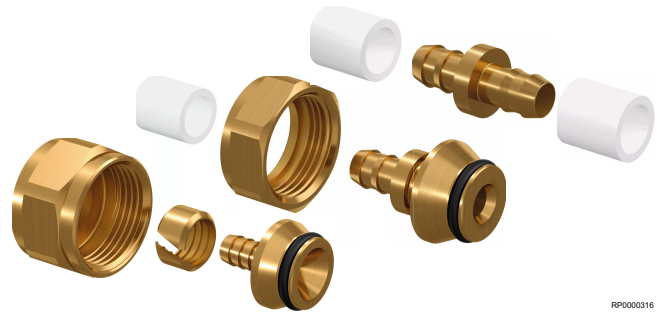

RP0000316

Uponor Q&E fittings have been specially developed for use with Uponor pipes.

Always use fittings with support sleeves together with Uponor pipes.

1.3 Copyright and disclaimer

“Uponor” is a registered trademark of Uponor Corporation.

Uponor has prepared this document solely for information purposes, images are only representations of the products. The content (text and images) of the document is protected by worldwide copyright laws and treaty provisions. You agree to comply with these when using the document. Modification or use of any of the content for any other purpose is a violation of Uponor’s copyright, trademark, and other proprietary rights.

While Uponor has made all effort to ensure that the document is accurate, the company does not guarantee or warrant the accuracy of the information. Uponor reserves the right to change the product portfolio and the related documentation without prior notification, in line with its policy of continuous improvement and development.

This is a generic, European-wide document version. The document may show products that are not available in your location for technical, legal, commercial, or other reasons. Therefore, check the Uponor product/price list in advance whether the product is deliverable in your location.

Always make sure that the system or product complies with current local standards and regulations. Uponor cannot guarantee the full compliance of the product portfolio and related documents with all local regulations, standards, or working methods.

Uponor disclaims all warranties related to the content of this document, expressed or implied, to the fullest extent permissible unless otherwise agreed or statutory.

Uponor is under no circumstances liable for any indirect, special, incidental, or consequential damage/loss that results from the use or inability to use the product portfolio and related documents.

For any questions or queries, please visit the local Uponor website or speak to your Uponor representative.

2 Planning/design

2.1 Floor constructions

Parquet/laminate design

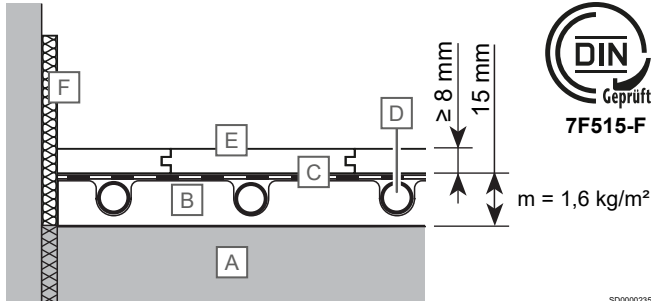

Item	Description
A	Existing floor
B	Uponor Siccus Mini panel
C	Uponor Multi PE foil
D	Uponor Minitec Comfort Pipe
E	Parquet/laminate
F	Uponor Minitec edging strip

Carpet/vinyl design

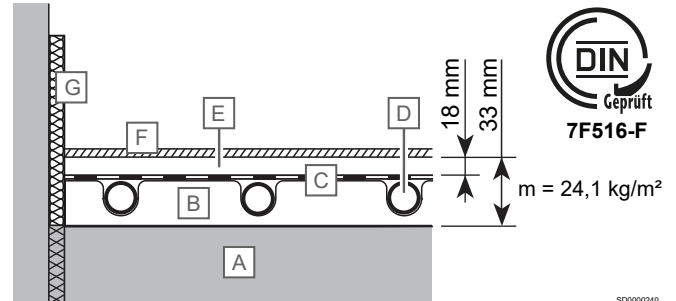

Item	Description
A	Existing floor
B	Uponor Siccus Mini panel
C	Uponor Multi PE foil
D	Uponor Minitec Comfort Pipe
E	Gypsum board
F	Carpet/vinyl
G	Uponor Minitec edging strip

Tiles/natural stone design

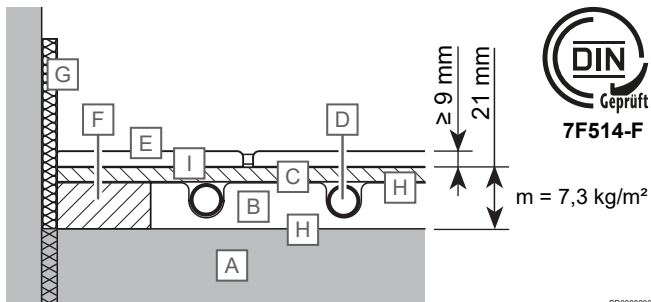

Item	Description
A	Existing floor
B	Uponor Siccus Mini panel
C	Uponor Siccus Mini tile-backer panel
D	Uponor Minitec Comfort Pipe
E	Tiles/natural stone
F	Uponor Siccus Mini edging strip
G	Uponor Minitec edging strip without foil
H	Glue
I	Primer + adhesive

Load-bearing subsurface

Uponor Siccus Mini is the ideal underfloor heating and cooling system for laying on top of the existing screed or suitable wooden construction. The existing underground is the load-bearing subsurface for the Siccus Mini system. The installer should inspect the subsurface for suitability and evenness and check if it is free of any deficiencies. To accept the existing underground, it must be sufficiently dry and have a level surface. It is not allowed to show bumps, pipes, cables or similar. Repair cracks according to the trade standards. The screed measurement tolerances must follow DIN 18202 as shown in the table below:

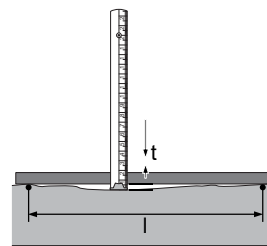

Limit values for flatness deviations

	Gauges as limit values [t] in mm with measuring point distances [l] in m				
	to 0,1	1 ¹⁾	4 ¹⁾	10 ¹⁾	15 ¹⁾
Finished floors - for example screeds for direct use, to install floor coverings, tile, coverings applied with adhesive	1	3	9	12	15

1) Intermediate values can be interpolated.

For parquet/laminate flooring, wooden beam construction with a max. deflection of 1/500 is permitted.

For tiles/natural stone flooring, the ground must be free from unevenness and wooden beam construction is not permitted.

2.2 Live loads for floor constructions

Flooring	Area and point load		Additional insulation		Re-inforcement layer	
	2 kN/m ² , 1 kN	2 kN/m ² , 2 kN	2 kN/m ² , 1 kN	2 kN/m ² , 2 kN	2 kN/m ² , 1 kN	2 kN/m ² , 2 kN
Parquet	-	≥ 8 mm	-	XPS, CS (10) 400, 20 mm	-	-
Laminate	-	min. ≥ 12 mm	-	XPS, CS (10) 400, 20 mm	-	-
Tiles	≥ 8 mm (for 100 - 300)	≥ 10 mm (for 100 - 600)	XPS, CS (10) 400, 20 mm	XPS, CS (10) 400, 20 mm	Siccus Mini tile-backer panel with edge support	
Natural stone	-	≥ 10 mm (for 100 - 600)	-	XPS, CS (10) 400, 20 mm	-	Siccus Mini tile-backer panel with edge support
Carpet (on top of the 18 mm gypsum board)	-	-	-	XPS, CS (10) 400, 20 mm	-	-
Vinyl (on top of the 18 mm gypsum board)	-	-	-	XPS, CS (10) 400, 20 mm	-	-

2.3 Dimensioning diagrams

Bathrooms, showers, toilets and the like are excluded when determining the design flow temperature.

The limit curves must not be exceeded.

$\Delta\vartheta_{H,G}$ is found through the limit curve for the occupied zone with the smallest pipe spacing.

The design supply water temperature maximum must be:

$$\Delta\vartheta_{V,des} = \Delta\vartheta_{H,G} + \Delta\vartheta_i + 2.5 \text{ K.}$$

In cooling mode the supply water temperature depends on the dew point temperature, therefore a humidity sensor has to be installed.

The following diagrams results are accurate and in accordance with EN 1264.

Abbreviations

These abbreviations are used in the following diagrams:

Abbreviations	Unit	Description
T	cm	Pipe spacing
s_u	mm	Thickness of the layer above the pipe
λ_u	W/mK	Thermal conductivity
ϑ_H	°C	Average temperature of the heating medium
$\Delta\vartheta_H$	K	Temperature difference between heating medium and room
ϑ_i	°C	Standard indoor room temperature
$\Delta\vartheta_c$	K	Temperature difference between room and cooling medium for cooling systems
$\vartheta_{F,max}$	°C	Maximum floor surface temperature
$\Delta\vartheta_{H,N}$	K	Standard temperature difference between heating medium and room for heating systems, with the exception of floor heating
$\Delta\vartheta_{C,N}$	K	Standard temperature difference between room and cooling medium for cooling systems
$\Delta\vartheta_{H,G}$	K	Limit temperature difference between heating medium and room for floor heating systems

Uponor Minitec Comfort Pipe 9,9 x 1,1 mm covered by parquet/laminate without screed load distribution layer (su = 8 mm with $\lambda u = 0,17 \text{ W/mK}$)

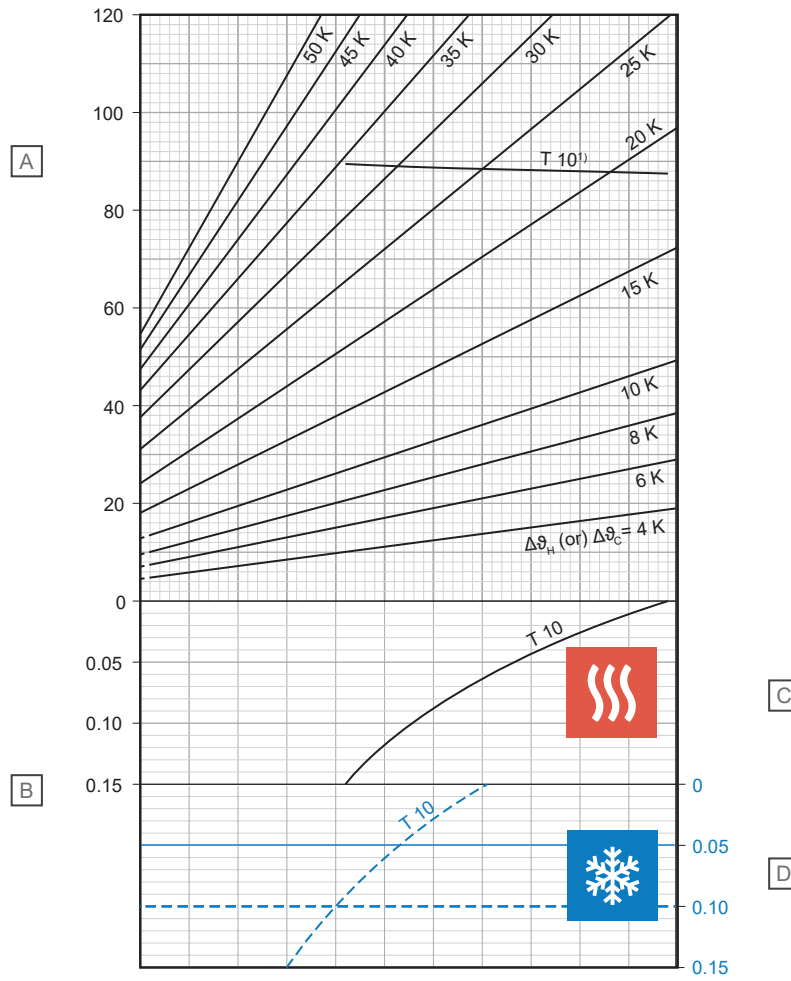

Item	Unit	Description
A	W/m ²	Specific thermal heating or cooling output [q _H or q _C]
B	m ² K/W	Thermal resistance [R _{λ,B}]

C - Heating

T (cm)	q _H (W/m ²)	Δθ _{H,N} (K)
10	87,7	18,3

D - Cooling

T (cm)	q _C (W/m ²)	Δθ _{C,N} (K)
10	28,5	8

¹⁾ Limit curve valid for θ_i 20 °C and θ_{F, max} 29 °C or θ_i 24 °C and θ_{F, max} 33 °C

Uponor Minitec Comfort Pipe 9,9 x 1,1 mm covered by tiles/natural stone with tile-backer panel (su = 6 mm with $\lambda_u = 0,100 \text{ W/mK}$)

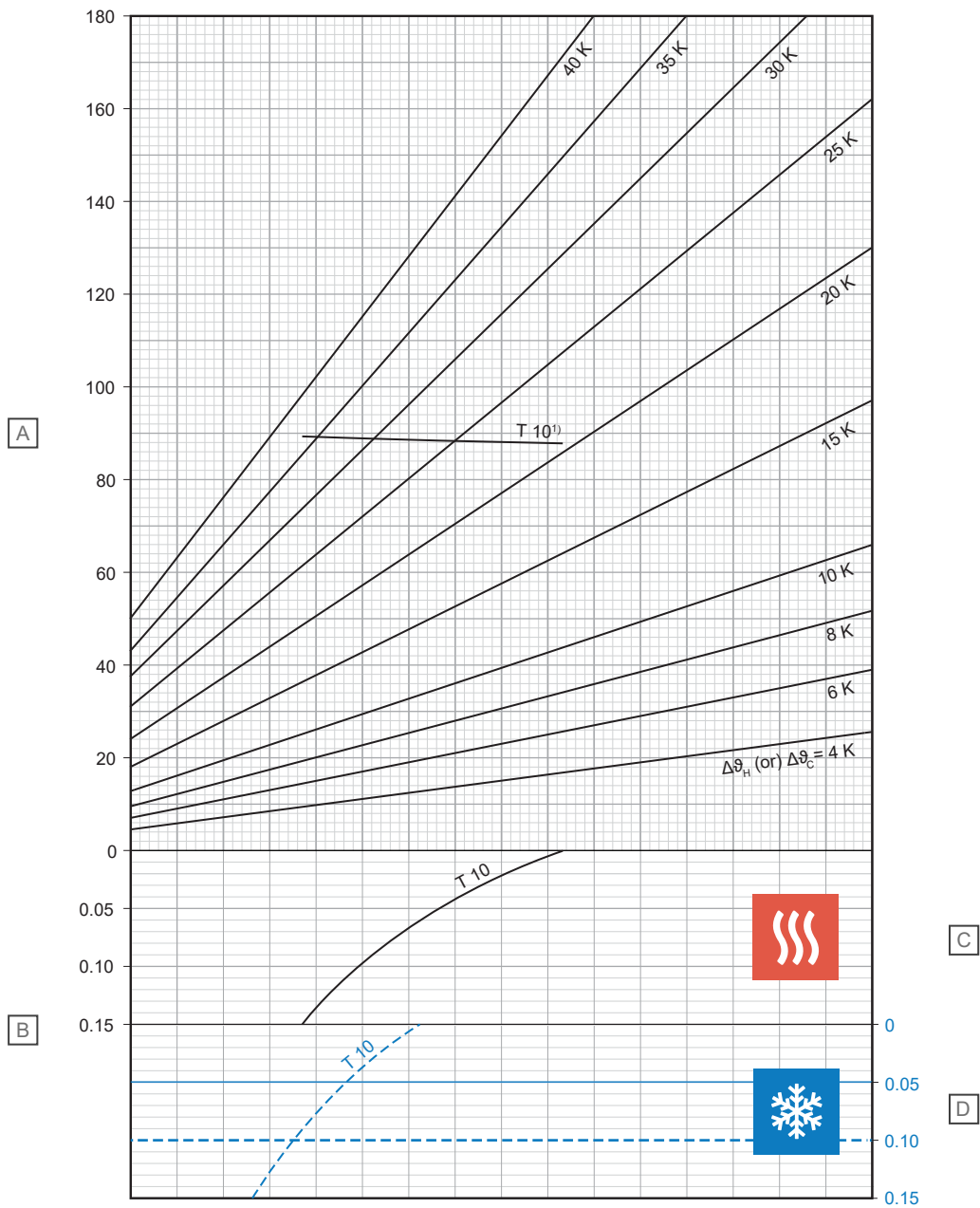

D10000210

Item	Unit	Description
A	W/m ²	Specific thermal heating or cooling output [q_H or q_C]
B	m ² K/W	Thermal resistance [$R_{\lambda,B}$]

C - Heating

T (cm)	q_H (W/m ²)	$\Delta\vartheta_{H,N}$ (K)
10	87,9	20,5

D - Cooling

T (cm)	q_C (W/m ²)	$\Delta\vartheta_{C,N}$ (K)
10	26,2	8

¹⁾ Limit curve valid for ϑ_i 20 °C and $\vartheta_{F, \max}$ 29 °C or ϑ_i 24 °C and $\vartheta_{F, \max}$ 33 °C

Uponor Minitec Comfort Pipe 9,9 x 1,1 mm covered by carpet/vinyl with gypsum board (su = 18 mm with $\lambda_u = 0,38 \text{ W/mK}$)

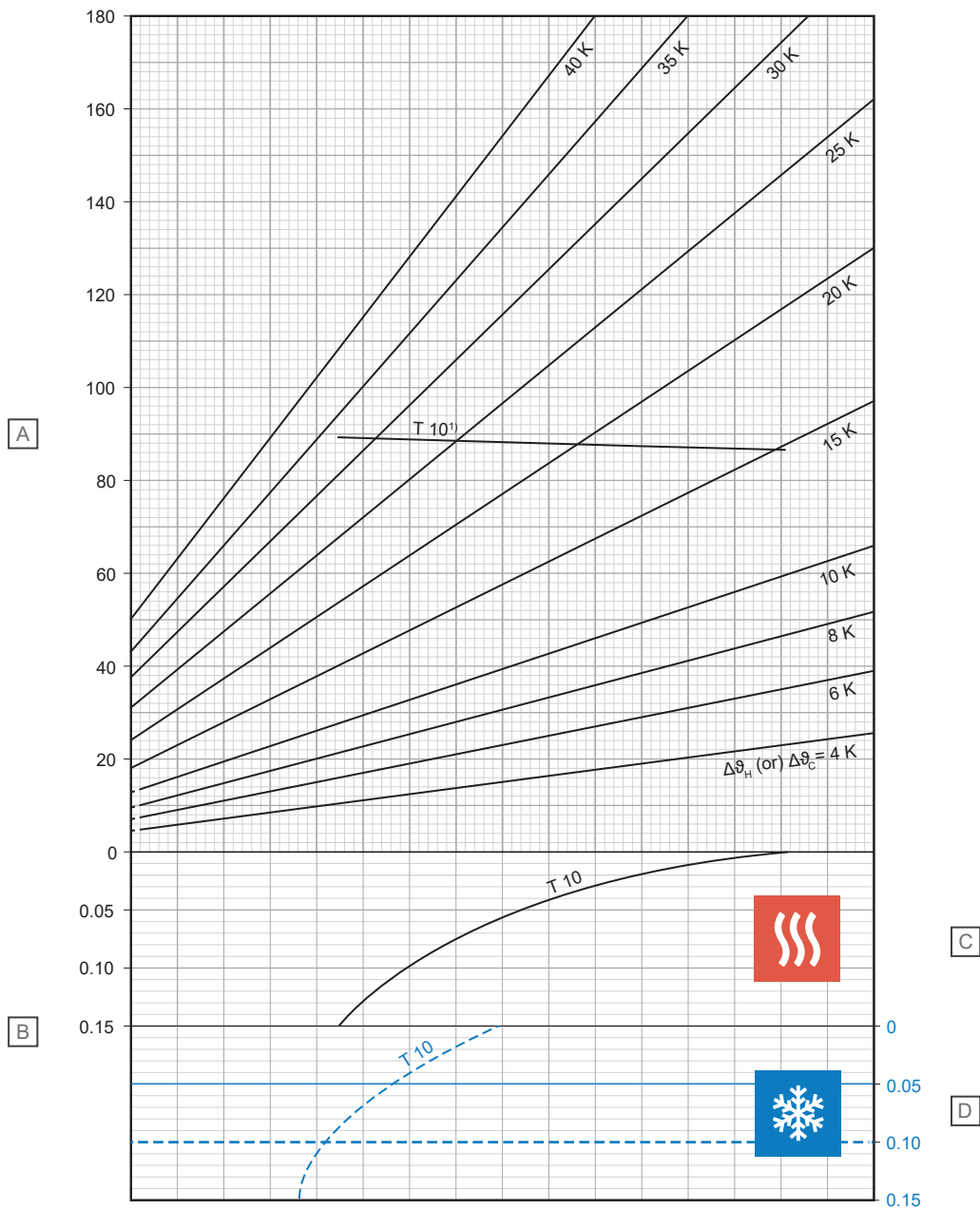

D0000213

Item	Unit	Description
A	W/m ²	Specific thermal heating or cooling output [q_H or q_C]
B	m ² K/W	Thermal resistance [$R_{\lambda,B}$]

C - Heating

T (cm)	q_H (W/m ²)	$\Delta\vartheta_{H,N}$ (K)
10	87,9	16,7

D - Cooling

T (cm)	q_C (W/m ²)	$\Delta\vartheta_{C,N}$ (K)
10	30,5	8

¹⁾ Limit curve valid for ϑ_i 20 °C and $\vartheta_{F, \max}$ 29 °C or ϑ_i 24 °C and $\vartheta_{F, \max}$ 33 °C

2.4 Pressure drop diagram for Uponor Minitec Comfort Pipe 9,9 x 1,1 mm

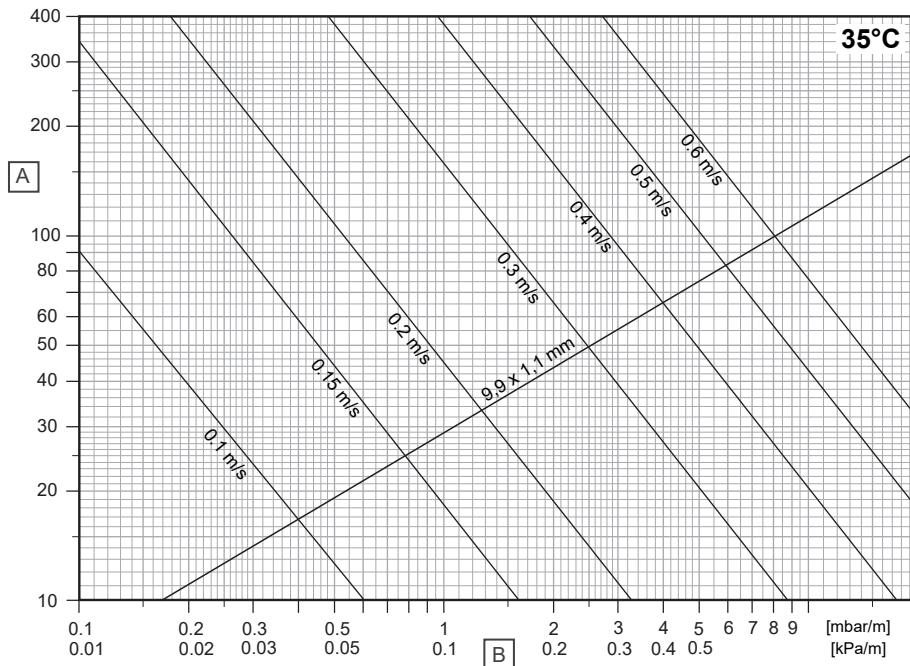

Item	Unit	Description
A	kg/h	Mass flow rate
B	R	Pressure gradient

2.5 Flooring materials

In the below table you can find the component systems from different manufacturers with which the Uponor Siccus Mini low installation system can be laid with various floor covering and in addition, you can find the time periods required. According to the information supplied by the manufacturer, there is a list of the components which have been tested and which are suitable for use with Uponor Siccus Mini.

However, the respective current manufacturer information must also be taken into consideration, as we cannot assume any liability for the correctness and up-to-dateness of the manufacturer statements. The fletcher must also check the suitability for the specific application. For the coordination of the construction site processes, corresponding agreements must be made between the people responsible for applying the levelling material, the installation and for laying the floor covering. The Uponor Siccus Mini installation manual must be observed (www.uponor.com/downloadcenter).

	Floor covering	
	Tiles	Carpet
Adhesive for the Siccus Mini panel	Loose-lay resilient flooring glue	-
Adhesive for the tile-backer panel	Loose-lay resilient flooring glue	-
Primer	Attachment primer for non-absorbent surfaces (as per adhesive mortar manufacturers' recommendations)	-
Tile adhesive	Adhesive mortar type S2, buttering-floating procedure	-
Grout	As per adhesive mortar manufacturers' recommendations	-
Gypsum board (18 mm)	-	Supplier approved constructions with glued joints

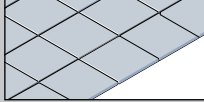
	Floor covering	
		
	Tiles	
Adhesive for the Siccus Mini panel	Ecofix	
Adhesive for the tile-backer panel	Ecofix	
Primer	Eco Prim Grip Plus	
Tile adhesive	Ultralite S2, buttering-floating procedure	
Grout	Ultracolor plus	

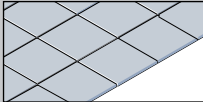
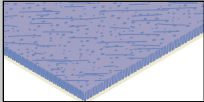
	Floor covering	
		
	Tiles	Carpet
Adhesive for the Siccus Mini panel	Knauf Brio Flächenkleber	-
Adhesive for the tile-backer panel	Knauf Brio Flächenkleber	-
Primer	Knauf special adhesive primer	-
Tile adhesive	Knauf Flexkleber schnell or Knauf Flexkleber Großformat (with additive Kleber- & Boden-Elast), buttering- floating procedure	-
Grout	Knauf Flexfuge universal	-
Gypsum board (18 mm)	-	Knauf GIFAfloor Hugo L 18 mm

3 Installation

3.1 Installation process

- Note**
Installation must be performed by a qualified person in accordance with local standards and regulations.
- Note**
Tiles/natural stone type coverings require additional installation steps compared to parquet/laminate type coverings. Refer to and follow the instructions given in the installation manual.

The installation process varies from country to country and must obey local regulations. Always follow the local standards and regulations whenever the Uponor systems should be installed.

As a guidance, always read and follow the instructions given in respective Uponor installation manual.

1. Multi-edging strip installation

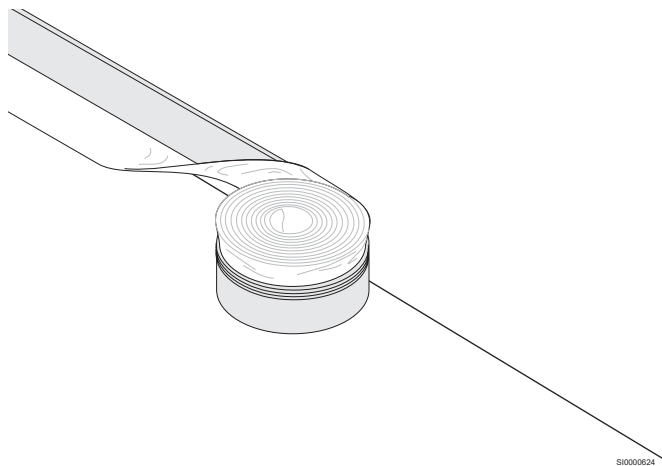

2. Panels installation

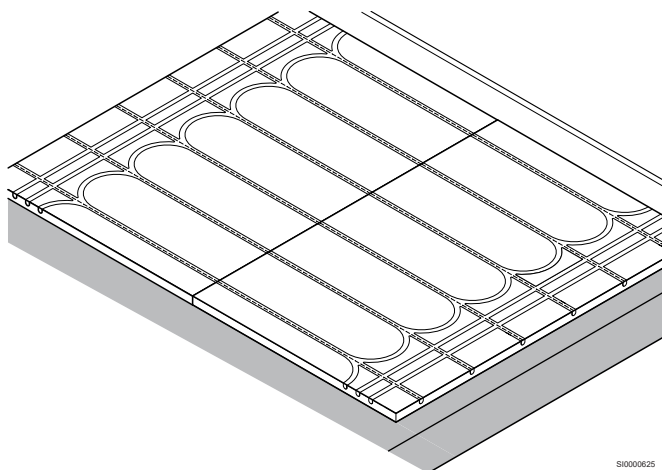

3. Pipes installation

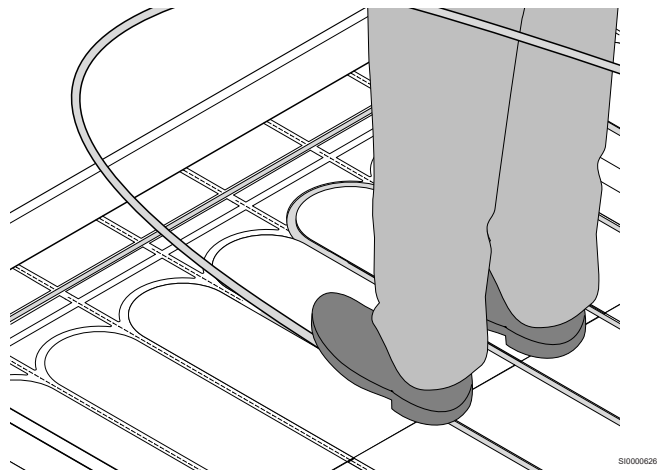

4. Connecting pipes to the manifold

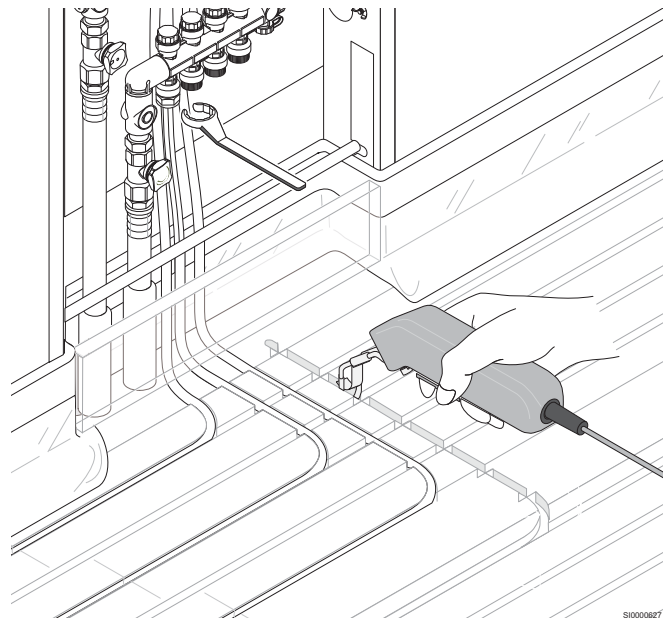

4 Technical data

4.1 Technical specifications

Uponor Siccus Mini

Description	Value	Value	Value
Product name	Uponor Siccus Mini panel	Uponor Siccus Mini tile-backer panel	Uponor Siccus Mini edging strip panel
Material	XPS 400kpa	High density synthetic fiber	High density synthetic fiber
Dimension	1200 x 600 x 15 mm	1000 x 600 x 6 mm	1000 x 45 x 15 mm
Max. live load	See floor construction type 2.2	See floor construction type 2.2	See floor construction type 2.2
Thermal conductivity	0,037 W/mK	0,11 W/mK	0,11 W/mK
Thermal resistance	0,27 m ² K/W	0,022 m ² K/W	-
Fire behaviour acc. to EN 13501-1	Class E	Class E	Class E
Pipe spacing	100 mm	-	-
Type of system	Dry system	Dry system	Dry system
Load distribution layer	See floor construction type 2.1	See floor construction type 2.1	See floor construction type 2.1

Uponor Minitec Comfort Pipe

Description	Value
Product name	Uponor Comfort Pipe 9,9 x 1,1 mm
Pipe dimension	9,9 x 1,1 mm
Material	PE-Xa
Colour	Natural with a blue longitudinal stripe
Pipe marking	Uponor Minitec Comfort Pipe 9,9 x 1,1 EN ISO 15875 PE-Xa Class 4/8 bar, Oxygen diffusion tight/DIN 4726 3V279 (country code, Material code pipe, Material code evoh, Machine, Year, Month, Date) Made in (country)
Manufacturing	According to EN ISO 15875
Certificates	DIN CERTCO 3V279
Application	Class 4 / 6 bar (EN ISO 15875)
Max. operating temperature	90 °C (EN ISO 15875)
Max. peak temperature	100 °C (EN ISO 15875)
Max. operating pressure	6 bar at 70° C
Pipe jointings	Uponor screw connection Uponor Q&E technology
Weight	0,039 kg/m
Water volume	0,044 l/m
Oxygen tightness	According to ISO 17455; DIN 4726
Density	0,934 g/cm ³ /more flexible
Building material class	E according to EN 13501-1
Min. bending radius	8xd if free bending 5xd if supported bend (50 mm)
Pipe roughness	0,0007 mm
Best mounting temperature	≥ 0 °C
UV protection	Opaque cardboard (store remaining quantities in the cardboard box)
Water additives	Uponor anti-freeze agent GNF, material class 3 (EN 1717)

Uponor

Uponor GmbH

Industriestraße 56,
D-97437 Hassfurt, Germany

1139920 v1_05_2023_EN
Production: Uponor/SKA

Uponor reserves the right to make changes, without prior notification,
to the specification of incorporated components in line with its policy of
continuous improvement and development.



www.uponor.com