

Uponor Smatrix Base/Base PRO

RO Raport de instalare

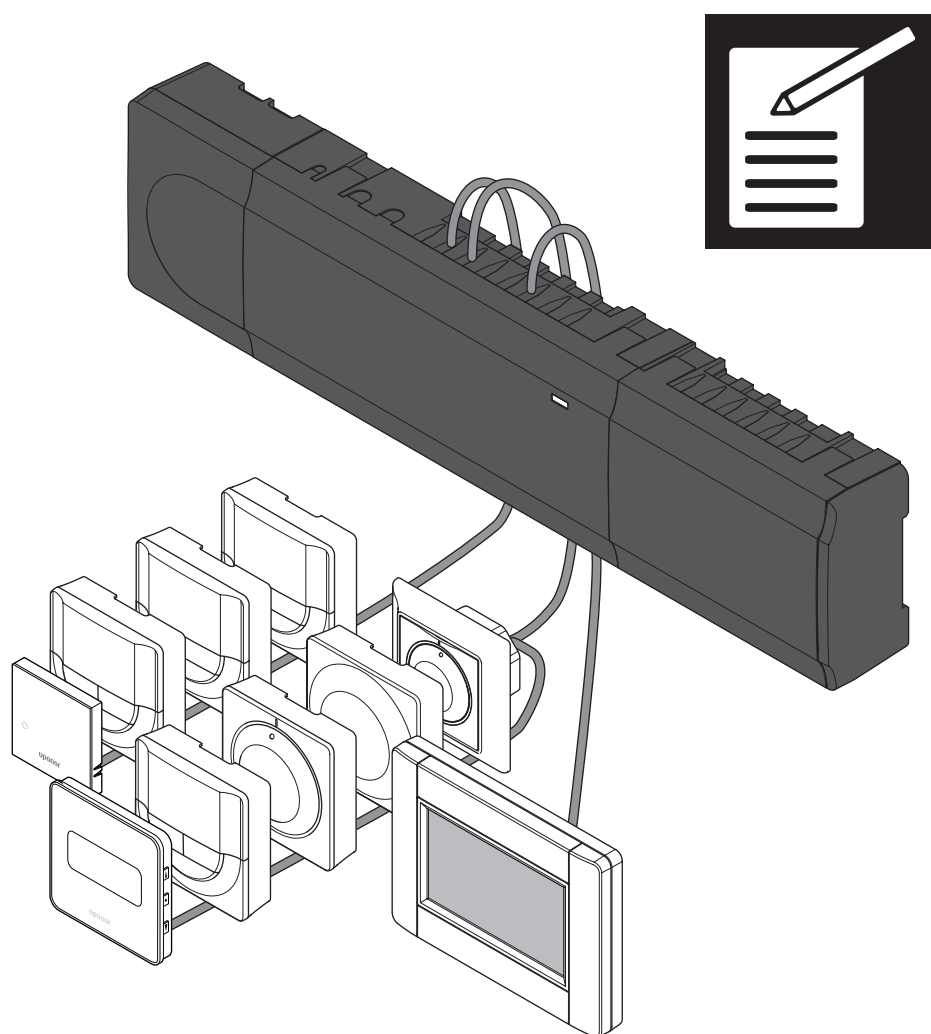

Raport de instalare

RO

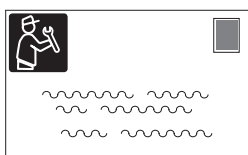

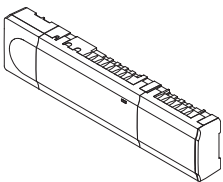
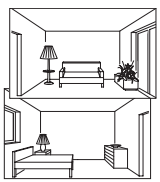

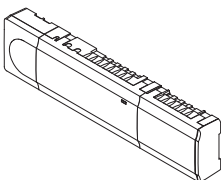
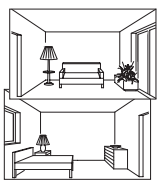





	Unitate de comandă								
	# 1	# 2	# 3	# 4	# 5	# 6	# 7	# 8	
Dispozitiv de sistem înregistrat									Nume cameră
Interfață									
Programator									
Senzorul de exterior									
Senzor comutare încălzire/răcire									
Comutator ECO/Comfort									
Pompă	Da <input type="checkbox"/>	Da <input type="checkbox"/>	Da <input type="checkbox"/>	Da <input type="checkbox"/>	Da <input type="checkbox"/>	Da <input type="checkbox"/>	Da <input type="checkbox"/>	Da <input type="checkbox"/>	
	Nu <input type="checkbox"/>	Nu <input type="checkbox"/>	Nu <input type="checkbox"/>	Nu <input type="checkbox"/>	Nu <input type="checkbox"/>	Nu <input type="checkbox"/>	Nu <input type="checkbox"/>	Nu <input type="checkbox"/>	
Modul stea	Da <input type="checkbox"/>	Da <input type="checkbox"/>	Da <input type="checkbox"/>	Da <input type="checkbox"/>	Da <input type="checkbox"/>	Da <input type="checkbox"/>	Da <input type="checkbox"/>	Da <input type="checkbox"/>	
	Nu <input type="checkbox"/>	Nu <input type="checkbox"/>	Nu <input type="checkbox"/>	Nu <input type="checkbox"/>	Nu <input type="checkbox"/>	Nu <input type="checkbox"/>	Nu <input type="checkbox"/>	Nu <input type="checkbox"/>	

	Unitate de comandă								
	# 9	# 10	# 11	# 12	# 13	# 14	# 15	# 16	
Dispozitiv de sistem înregistrat									Nume cameră
Interfață									
Pompă	Da <input type="checkbox"/>	Da <input type="checkbox"/>	Da <input type="checkbox"/>	Da <input type="checkbox"/>	Da <input type="checkbox"/>	Da <input type="checkbox"/>	Da <input type="checkbox"/>	Da <input type="checkbox"/>	
	Nu <input type="checkbox"/>	Nu <input type="checkbox"/>	Nu <input type="checkbox"/>	Nu <input type="checkbox"/>	Nu <input type="checkbox"/>	Nu <input type="checkbox"/>	Nu <input type="checkbox"/>	Nu <input type="checkbox"/>	
Modul stea	Da <input type="checkbox"/>	Da <input type="checkbox"/>	Da <input type="checkbox"/>	Da <input type="checkbox"/>	Da <input type="checkbox"/>	Da <input type="checkbox"/>	Da <input type="checkbox"/>	Da <input type="checkbox"/>	
	Nu <input type="checkbox"/>	Nu <input type="checkbox"/>	Nu <input type="checkbox"/>	Nu <input type="checkbox"/>	Nu <input type="checkbox"/>	Nu <input type="checkbox"/>	Nu <input type="checkbox"/>	Nu <input type="checkbox"/>	

Unitate de comandă 1

RO

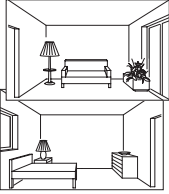
Termostat	Canal unitate de comandă						Canal de modul de extindere					
	1	2	3	4	5	6	7	8	9	10	11	12
 T-149												
 T-148												
 T-146												
 T-145												
 T-144												
 T-143												
 T-141												
Senzor extern conectat												
Senzor de pardoseală												
Senzorul de exterior												
Senzor la distanță												
Actuator conectat												
												
Nume cameră												
												



.....

.....

.....









.....

.....

.....

Unitate de comandă 2

RO

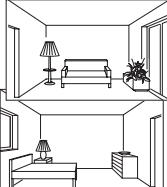
Termostat	Canal unitate de comandă						Canal de modul de extindere					
	1	2	3	4	5	6	7	8	9	10	11	12
 T-149												
 T-148												
 T-146												
 T-145												
 T-144												
 T-143												
 T-141												
Senzor extern conectat												
Senzor de pardoseală												
Senzorul de exterior												
Senzor la distanță												
Actuator conectat												
												
Nume cameră												
												



.....

.....









.....

.....

.....

.....

Unitate de comandă 3

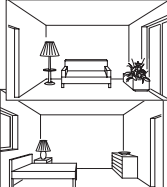
Termostat	Canal unitate de comandă						Canal de modul de extindere					
	1	2	3	4	5	6	7	8	9	10	11	12
 T-149												
 T-148												
 T-146												
 T-145												
 T-144												
 T-143												
 T-141												
Senzor extern conectat												
Senzor de pardoseală												
Senzorul de exterior												
Senzor la distanță												
Actuator conectat												
												
Nume cameră												
												



.....

.....

.....









.....

.....

.....

Unitate de comandă 5

RO

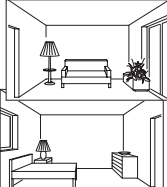
Termostat	Canal unitate de comandă						Canal de modul de extindere					
	1	2	3	4	5	6	7	8	9	10	11	12
 T-149												
 T-148												
 T-146												
 T-145												
 T-144												
 T-143												
 T-141												
Senzor extern conectat												
Senzor de pardoseală												
Senzorul de exterior												
Senzor la distanță												
Actuator conectat												
												
Nume cameră												
												



.....

.....

.....

.....









.....

.....

Unitate de comandă 5 – 16

Utilizați această pagină ca șablon pentru unitățile de comandă Smatrix Base PRO 5 – 16

RO

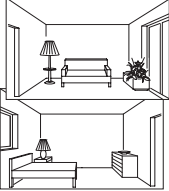
Termostat	Canal unitate de comandă						Canal de modul de extindere					
	1	2	3	4	5	6	7	8	9	10	11	12
 T-149												
 T-148												
 T-146												
 T-145												
 T-144												
 T-143												
 T-141												
Senzor extern conectat												
Senzor de pardoseală												
Senzorul de exterior												
Senzor la distanță												
Actuator conectat												
												
Nume cameră												
												



.....

.....

.....

.....

.....

.....

Uponor

Uponor România S.R.L.

Splaiul Unirii 76, parter, Sector 4
040037 București

1143287 v1_11_2023_RO
Production: Uponor / ELO

Uponor își rezervă dreptul de a modifica portofoliul de produse și documentația aferentă fără notificare prealabilă, conform politicii de îmbunătățire și dezvoltare continuă.



www.uponor.com/ro-ro