

4

3

2

1

F

F

E

E

D

D

C

C

B

B

A

A

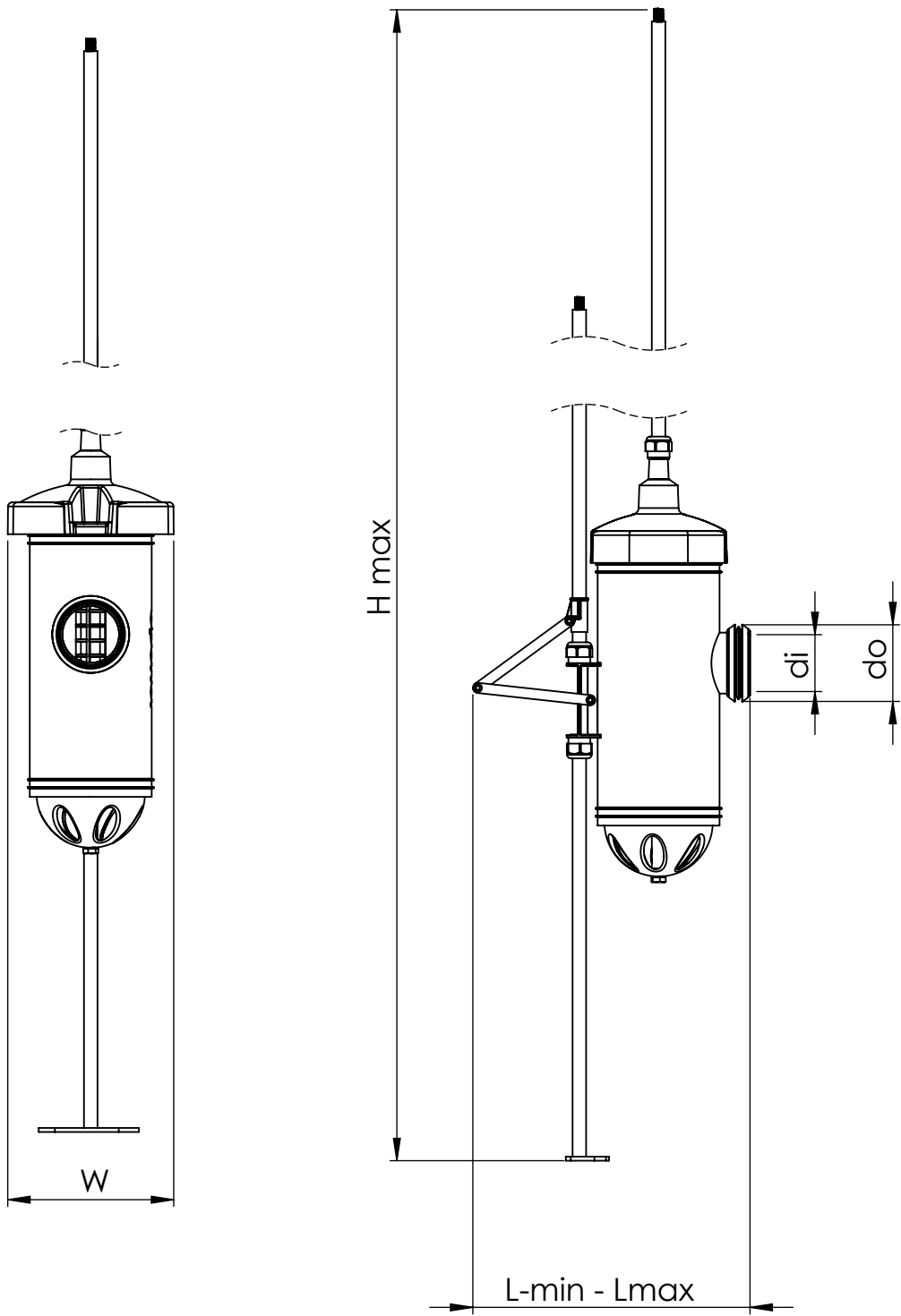

Item	Lmin.	Lmax.	Hmax.	do	di	W	Weight
1143761	315	576	2500	110	90	245	4,5

uponor

Description
Z-drawing
Item 1143761

Drawing number
0000332671_Zdim

Sheet: 1/1

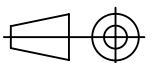

4

3

2

1