

Klauke[®]

Uponor

Uponor UPP1 S-Press jaw 14–50

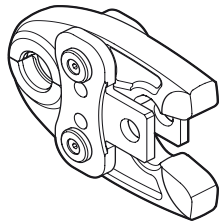
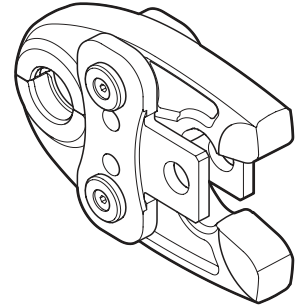

+

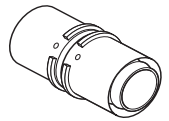
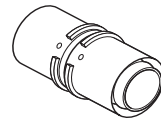
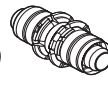
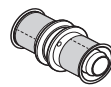
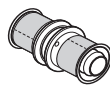



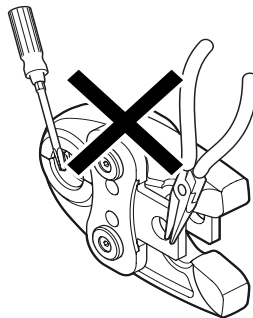
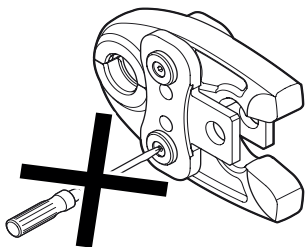
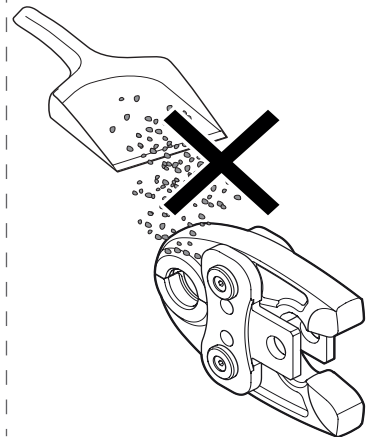
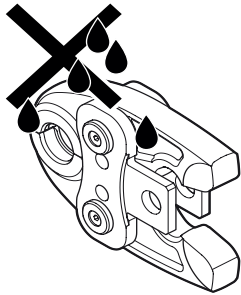



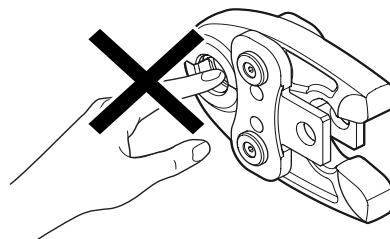

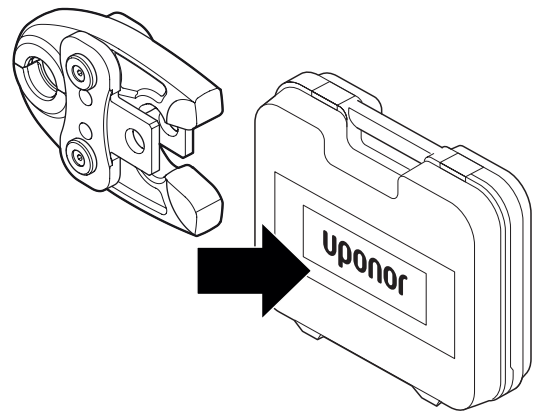
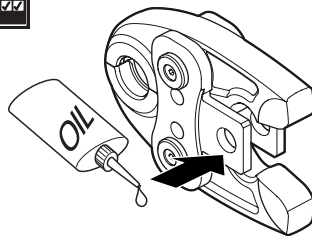
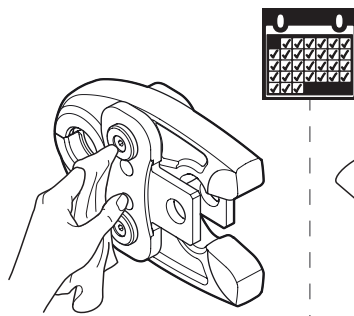
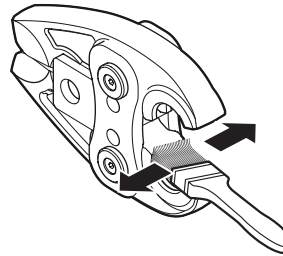
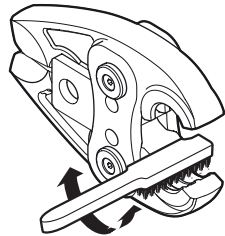
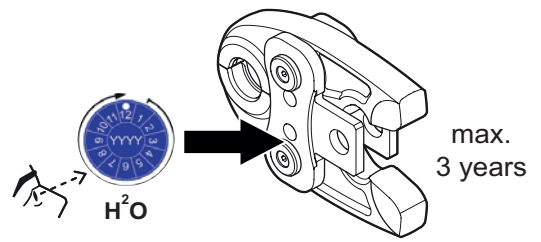
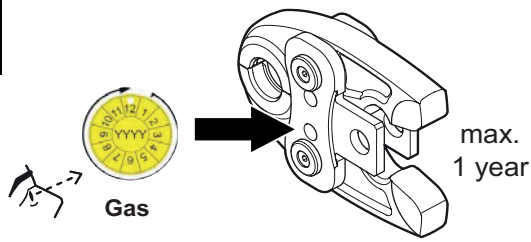

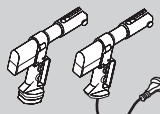
uponor



Uponor
Service





		UP110 UP75 UP75 EL 	
		 UPP1	 UPP1
S-Press PLUS S-Press PLUS PPSU		16 – 32	–
S-Press		14 – 32	–
S-Press S-Press PPSU		–	40 – 50
RS		 16 – 32	 40 – 50
Smart		 14 – 20	–



NL only:
Registratie van de
Uponor persgereedschappen



[www.uponor.com/services/
download-centre](http://www.uponor.com/services/download-centre)

Gustav Klauke GmbH

Auf dem Knapp 46,
D-42855 Remscheid, Germany
Phone +49 (0)2191 907-2321
Fax +49 (0)2191 907-251
www.klauke.com

Uponor GmbH

Industriestraße 56,
D-97437 Hassfurt, Germany

1087250 v2_11-2024_INT
Production: Uponor / SKA

Uponor reserves the right to make changes, without prior notification,
to the specification of incorporated components in line with its policy
of continuous improvement and development.



www.uponor.com