

Uponor Smatrix Base/Base PRO

CZ Instalační zpráva

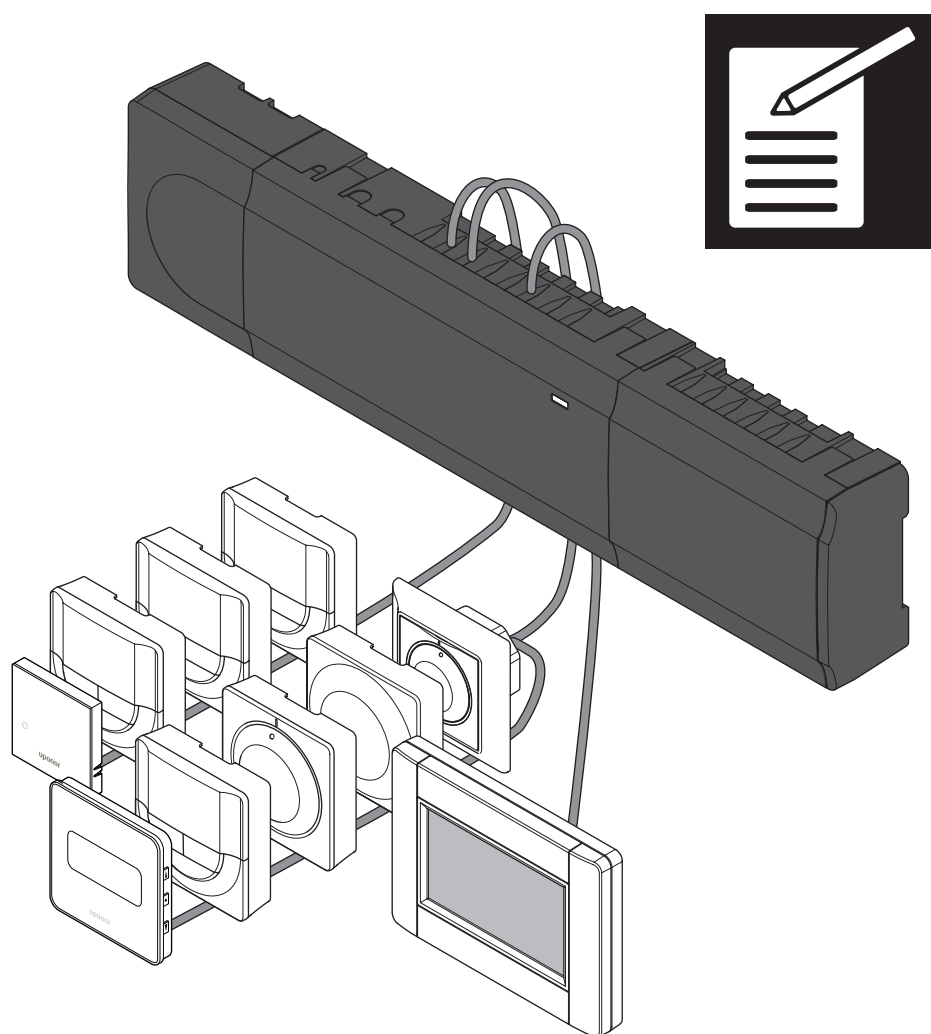

Instalační zpráva

CZ

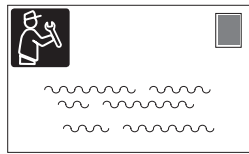
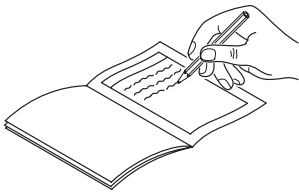

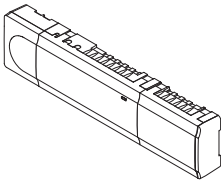
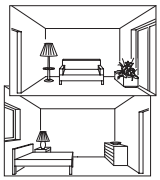

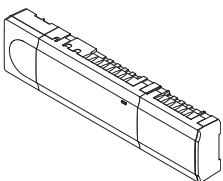
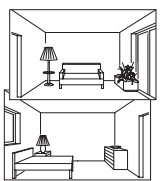





	Řídicí jednotka								
	č. 1	č. 2	č. 3	č. 4	č. 5	č. 6	č. 7	č. 8	
Registrované systémové zařízení									Název místnosti
Interface									
Hodiny									
Venkovní čidlo									
Čidlo spínače vytápění/chlazení									
Spínač ECO/Comfort									
Čerpadlo	Ano <input type="checkbox"/>	Ano <input type="checkbox"/>	Ano <input type="checkbox"/>	Ano <input type="checkbox"/>	Ano <input type="checkbox"/>	Ano <input type="checkbox"/>	Ano <input type="checkbox"/>	Ano <input type="checkbox"/>	
	Ne <input type="checkbox"/>	Ne <input type="checkbox"/>	Ne <input type="checkbox"/>	Ne <input type="checkbox"/>	Ne <input type="checkbox"/>	Ne <input type="checkbox"/>	Ne <input type="checkbox"/>	Ne <input type="checkbox"/>	
hvězdicový modul	Ano <input type="checkbox"/>	Ano <input type="checkbox"/>	Ano <input type="checkbox"/>	Ano <input type="checkbox"/>	Ano <input type="checkbox"/>	Ano <input type="checkbox"/>	Ano <input type="checkbox"/>	Ano <input type="checkbox"/>	
	Ne <input type="checkbox"/>	Ne <input type="checkbox"/>	Ne <input type="checkbox"/>	Ne <input type="checkbox"/>	Ne <input type="checkbox"/>	Ne <input type="checkbox"/>	Ne <input type="checkbox"/>	Ne <input type="checkbox"/>	

	Řídicí jednotka								
	č. 9	č. 10	č. 11	č. 12	č. 13	č. 14	č. 15	č. 16	
Registrované systémové zařízení									Název místnosti
Interface									
Čerpadlo	Ano <input type="checkbox"/>	Ano <input type="checkbox"/>	Ano <input type="checkbox"/>	Ano <input type="checkbox"/>	Ano <input type="checkbox"/>	Ano <input type="checkbox"/>	Ano <input type="checkbox"/>	Ano <input type="checkbox"/>	
	Ne <input type="checkbox"/>	Ne <input type="checkbox"/>	Ne <input type="checkbox"/>	Ne <input type="checkbox"/>	Ne <input type="checkbox"/>	Ne <input type="checkbox"/>	Ne <input type="checkbox"/>	Ne <input type="checkbox"/>	
hvězdicový modul	Ano <input type="checkbox"/>	Ano <input type="checkbox"/>	Ano <input type="checkbox"/>	Ano <input type="checkbox"/>	Ano <input type="checkbox"/>	Ano <input type="checkbox"/>	Ano <input type="checkbox"/>	Ano <input type="checkbox"/>	
	Ne <input type="checkbox"/>	Ne <input type="checkbox"/>	Ne <input type="checkbox"/>	Ne <input type="checkbox"/>	Ne <input type="checkbox"/>	Ne <input type="checkbox"/>	Ne <input type="checkbox"/>	Ne <input type="checkbox"/>	

Řídicí jednotka 1

CZ

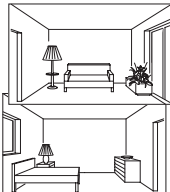
Termostat	Kanál řídicí jednotky						Kanál podřízeného modulu					
	1	2	3	4	5	6	7	8	9	10	11	12
 T-149												
 T-148												
 T-146												
 T-145												
 T-144												
 T-143												
 T-141												
Připojené externí čidlo												
Podlahový snímač												
Venkovní čidlo												
Vzdálené čidlo												
Připojený servopohon												
												
Název místnosti												
												



.....

.....

.....

.....









.....

.....

.....

Řídicí jednotka 2

CZ

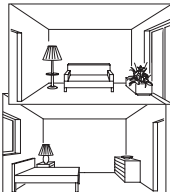
Termostat	Kanál řídicí jednotky						Kanál podřízeného modulu					
	1	2	3	4	5	6	7	8	9	10	11	12
 T-149												
 T-148												
 T-146												
 T-145												
 T-144												
 T-143												
 T-141												
Připojené externí čidlo												
Podlahový snímač												
Venkovní čidlo												
Vzdálené čidlo												
Připojený servopohon												
												
Název místnosti												
												



.....

.....

.....









.....

.....

.....

.....

Řídicí jednotka 3

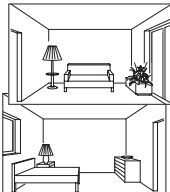
Termostat	Kanál řídicí jednotky						Kanál podřízeného modulu					
	1	2	3	4	5	6	7	8	9	10	11	12
 T-149												
 T-148												
 T-146												
 T-145												
 T-144												
 T-143												
 T-141												
Připojené externí čidlo												
Podlahový snímač												
Venkovní čidlo												
Vzdálené čidlo												
Připojený servopohon												
												
Název místnosti												
												



.....

.....

.....









.....

.....

.....

Řídicí jednotka 4

CZ

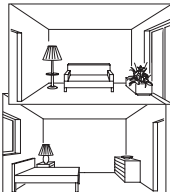
Termostat	Kanál řídicí jednotky						Kanál podřízeného modulu					
	1	2	3	4	5	6	7	8	9	10	11	12
 T-149												
 T-148												
 T-146												
 T-145												
 T-144												
 T-143												
 T-141												
Připojené externí čidlo												
Podlahový snímač												
Venkovní čidlo												
Vzdálené čidlo												
Připojený servopohon												
 24 V												
Název místnosti												
												



.....

.....

.....

.....

.....









.....

.....

Řídicí jednotka 5 – 16

Tuto stránku použijte jako šablonu pro řídicí jednotky Smatrix Base PRO 5 – 16

CZ

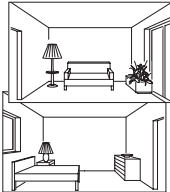
Termostat	Kanál řídicí jednotky						Kanál podřízeného modulu					
	1	2	3	4	5	6	7	8	9	10	11	12
 T-149												
 T-148												
 T-146												
 T-145												
 T-144												
 T-143												
 T-141												
Připojené externí čidlo												
Podlahový snímač												
Venkovní čidlo												
Vzdálené čidlo												
Připojený servopohon												
												
Název místnosti												
												



.....

.....

.....

.....

.....

.....

Uponor

Uponor, s.r.o.

Zelený pruh 95/97,
140 00 Praha 4 – Braník

1143271 v1_11_2023_CZ
Production: Uponor / ELO

Společnost Uponor si vyhrazuje právo bez předchozího upozornění měnit sortiment svých produktů a související dokumentace v souladu se svými vnitropodnikovými zásadami neustálého zlepšování a vývoje.



www.uponor.cs-cz