

Aqua/ Combi Port M-INS, Combi Port E-INS

EN	Quick guide
BG	Кратко ръководство
CZ	Stručný průvodce
DK	Lynguide
ES	Guía rápida
HR	Brzi vodič
HU	Rövid szerelési útmutató

PL	Krótki przewodnik
PT	Guia rápida
RO	Ghid rapid
SI	Hitri vodič
SK	Stručný návod
INT	

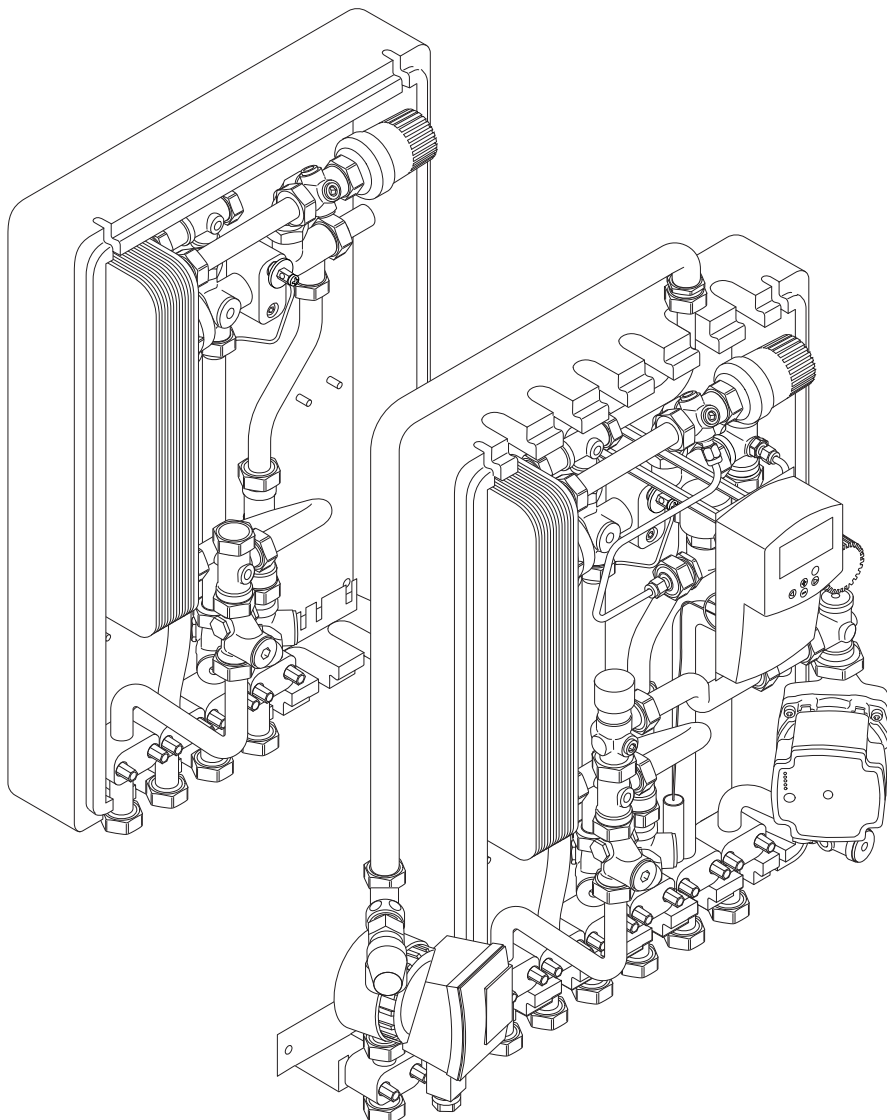









Table of contents

EN	EN	3	 INT	27
	1 Installation.....	3		
BG	BG	5		
	1 Монтаж.....	5		
CZ	CZ	7		
	1 Instalace.....	7		
DK	DK	9		
	1 Installation.....	9		
ES	ES	11		
	1 Instalación.....	11		
HR	HR	13		
	1 Postavljanje.....	13		
HU	HU	15		
	1 Telepítés.....	15		
PL	PL	17		
	1 Montaż.....	17		
PT	PT	19		
	1 Instalação.....	19		
RO	RO	21		
	1 Instalarea.....	21		
SI	SI	23		
	1 Vgradnja.....	23		
SK	SK	25		
	1 Montáž.....	25		

1 Installation

1.1 General information

	Warning! Risk of electric shock if touching the components! The unit operates with a 230 V AC voltage.
	Warning! Risk of electrical shock! Electrical installation and service behind secured 230 V AC covers must be carried out under the supervision of a qualified electrician.
	Warning! Upon system power supply: 230 V AC, 50 Hz. In case of emergency, immediately disconnect the power.
	Warning! Prior to any work on the controller or the components connected to it, switch off the controller according to the regulations.
	Warning! The fittings are under pressure. Escaping pressurized media can cause serious injury such as scalding or eye damage. Depressurise the system before performing any installation work. For retrofits to an existing system: Drain the system or close the supply lines of the section and depressurise it.
	Warning! Risk of injury due to the heavy weight of the unit: Do not perform the installation alone. Always wear safety shoes during the assembly. The unit can be of considerable weight, depending on the configuration. If the station falls over, this could lead to injuries, particularly to the feet.
	Caution! Leaks in the unit may occur during transport or installation. Check the nuts to ensure that they are properly tightened before the connection to avoid property damages.

Before installing the heat interface unit ensure that:

- the primary pipes are laid in the building site.
- the primary pipe installation is flushed and checked for leaks
- the power and ground cables are routed to the installation site.
- the unit is installed in a dry and frost-free room with an ambient temperature lower than +40 °C.
- the unit is mounted upright (not inclined, upside down or lying down).
- the unit is always easy to access even after the assembly.

Related illustrations



Illustrations related to the different sections below are available in the end of this document.

1.2 Heat interface unit

	Note See the dimensional drawings for measurements. All dimensions are given in mm.
---	---

1. Mark where to drill the holes.
2. Drill the holes.
3. Fix the HIU to the wall using the provided material.

1.3 Components

Strainer

	Caution! Shut off the water supply to the unit and relieve the pressure before any work with the strainer.
---	--

The strainer collects dirt and its filter can be removed for inspection and cleaning.

Heat meter distance piece

	Note The distance pieces are not suitable for continuous operation.
---	---



Heating pump

	Note It is recommended that the pump runs at constant pressure when used for underfloor heating. The factory setting of the pump is not set to constant pressure and must therefore be changed
---	--

The pump (Grundfos UPM3) has to be set to the constant pressure modus ($\Delta p-c$) to enable an optimal operation of the underfloor heating system.



The settings are done on the pump house as described in the installation and operation manual.

1.4 Hydraulic installation

	Warning! Leaks can cause personal injury and property damages.
	Note Install the pipes in accordance with the planning documentation.

Connect the primary supply lines with the corresponding 3/4" ball valves at the HIU.



1.5 Electrical installation

	Warning! Required work must be performed by a qualified installer in accordance with local regulations. This includes electrical connections and installations, set up for operation and maintenance.
	Warning! Establish equipotential bonding by using a copper equipotential bonding conductor (cross-section at least 6 mm ²). Connect the earthing clamp to a suitable equipotential bonding rail in the building.

1.6 Filling and flushing

Fill and flush the system according to local regulations and standards.

1.7 Tightness testing

	Warning! Leaks can cause personal injury and property damages.
	Caution! Pressure leaks may occur even at normal operating pressure and must be repaired immediately.



Minimum 2 hours



According to local standards and regulations

1.8 Finishing the installation and hand over







	Caution! Incorrect finishing of the installation can lead to property damage.
---	---

Follow these steps and finish the installation:

1. Check the settings.
2. Complete the acceptance/ finishing protocol.
3. Hand over the documentation and the protocol to the homeowner.

1 Монтаж

1.1 Обща информация

	Предупреждение! Риск от токов удар при докосване на компонентите! Модулът работи с напрежение 230 V AC.
	Предупреждение! Риск от токов удар! Електрическата инсталация и обслужване зад защитените покрития за 230 V AC трябва да се извършват под наблюдението на квалифициран електротехник.
	Предупреждение! Захранване на система Uponor: 230 V AC, 50 Hz. При авария веднага изключете захранването.
	Предупреждение! Преди каквато и да е работа по контролера или компонентите, свързани с него, изключете контролера съгласно разпоредбите.
	Предупреждение! Фитингите са под налягане. Изтичането на вещество под налягане може да причини сериозни наранявания като изгаряне или увреждане на очите. Дехерметизирайте системата, преди да изпълните каквито и да е монтажни работи. За преоборудване на съществуваща система: Източете системата или затворете захранващите линии на секцията и дехерметизирайте.
	Предупреждение! Опасност от нараняване поради голямото тегло на модула: Не извършвайте монтажа сами. Винаги носете предпазни обувки по време на монтажа. Модулът може да има значително тегло в зависимост от конфигурацията. Ако станцията падне, това може да доведе до наранявания, особено на краката.
	Внимание! По време на транспортиране или монтаж могат да възникнат течове в модула. Проверете гайките, за да се уверите, че са добре затегнати преди свързването, с цел избягване на имуществени щети.

Преди да монтирате модула за топлинен интерфейс, се уверете, че:

- първичните тръби са поставени на строителната площадка.
- първичната тръбна инсталация се промива и проверява за течове.
- захранващите и заземяващите кабели се прокарват до мястото на монтажа.
- колекторът се монтира в сухо и защитено от замръзване помещение с температура на околната среда под +40°C.

- колекторът се монтира изправен (не наклонен, обърнат или легнал).
- колекторът е винаги лесно достъпен дори след сглобяване.

Свързани илюстрации



Илюстрации, свързани с различните раздели по-долу, са налични в края на този документ.

1.2 Модул за топлинен интерфейс



Забележка

Вижте чертежите с размери за мерките. Всички размери са дадени в mm.

1. Отбележете къде да пробиеете дупките.
2. Пробийте дупките.
3. Фиксирайте HIU към стената, като използвате предоставените средства.

1.3 Компоненти

Филтърен утаител



Внимание!

Спрете подаването на вода към уреда и облекчете налягането преди каквато и да е работа с филтърния утаител.

Филтърният утаител събира мръсотията, като филтърът му може да се свали за проверка и почистване.

Дистанционер за поставяне на топломер



Забележка

Дистанционните детайли не са подходящи за продължителна експлоатация.

Отоплителна помпа



Забележка

Препоръчително е помпата да работи при постоянно налягане, когато се използва за подово отопление. Фабричната настройка на помпата не е настроена на постоянно налягане и поради това трябва да се промени

Помпата (Grundfos UPM3) трябва да бъде настроена на режим на постоянно налягане (Dr-c), за да позволи оптимална работа на системата за подово отопление.

Настройките се извършват на помпената станция, както е описано в ръководството за монтаж и експлоатация.

1.4 Монтаж на хидравличната система

	Предупреждение! Течовете могат да причинят наранявания и имуществени щети.
---	--

	Забележка Монтирайте тръбите в съответствие с проектната документация.
---	--

Свържете първичните захранващи линии със съответните ¾" сферични вентили на HIU.

1.5 Електрическа инсталация

	Предупреждение! Необходимата работа трябва да се извърши от квалифициран монтажник в съответствие с местните разпоредби. Това включва електрическите връзки и инсталации, настройването за работа и поддръжката.
---	--

	Предупреждение! Осъществете еквипотенциално свързване, като използвате меден проводник за еквипотенциално свързване (напречно сечение най-малко 6 mm ²). Свържете заземителната скоба към подходяща релса за еквипотенциално свързване в сградата.
---	--

1.6 Пълнене и промиване

Напълнете и промийте системата в съответствие с местните разпоредби и стандарти.

1.7 Тестване на херметичност

	Предупреждение! Течовете могат да причинят наранявания и имуществени щети.
---	--

	Внимание! Течове под налягане могат да се появят дори при нормално работно налягане и трябва да бъдат коригирани незабавно.
---	---



Минимум 2 часа



Според местните стандарти и разпоредби

1.8 Завършване на монтажа и предаване

	Внимание! Неправилното завършване на инсталацията може да доведе до материални щети.
--	--

Изпълнете следните стъпки и завършете монтажа:







1. Проверете настройките.
2. Попълнете протокола за приемане/завършване.
3. Предайте документацията и протокола на собственика на жилището.

Aqua/ Combi Port M-INS, Combi Port E-INS

Stručný průvodce

1 Instalace

1.1 Obecné informace

	Výstraha! Nebezpečí úrazu elektrickým proudem při kontaktu se součástmi! Zařízení vyžaduje napětí 230 V~.
	Výstraha! Nebezpečí úrazu elektrickým proudem! Elektrická instalace a zásahy za zabezpečenými kryty 230 V~ musí probíhat pod dohledem kvalifikovaného elektrotechnika.
	Výstraha! Systém Uponor využívá napájení 230 V~, 50 Hz. V nouzových případech napájení neprodleně odpojte.
	Výstraha! Před jakoukoli prací na řídicí jednotce nebo jejích součástech je třeba řídicí jednotku v souladu s předpisy vypnout.
	Výstraha! Tvarovky jsou pod tlakem. Únik látek pod tlakem může způsobit vážné zranění, například opaření nebo poranění očí. Před jakýmkoli instalačními pracemi systém odvědušněte. V případě dodatečné montáže do existujícího systému: Systém vyprázdněte nebo uzavřete přívody v sekci a odvědušněte ji.
	Výstraha! Vysoká hmotnost zařízení může způsobit zranění: Instalaci neprovádějte sami. V průběhu instalace mějte na sobě bezpečnostní obuv. Zařízení má v závislosti na konfiguraci vysokou hmotnost. Při pádu může stanice způsobit zranění, především poranění nohou.
	Upozornění! V průběhu přepravy nebo instalace může dojít k poškození vedoucímu k únikům. Před připojením zkontrolujte správné utažení matic, můžete tak předejít vzniku škody na majetku.

Před instalací bytové stanice se ujistěte, že:

- Primární potrubí je na stavbě položeno.
- Potrubí na místě instalace je vypláchnuté a zkontrolované z hlediska netěsností.
- Místo instalace je vybaveno napájecími a uzemňovacími kabely.
- Stanice se instaluje v nezamrzající suché místnosti, v níž okolní teplota nepřesahuje +40 °C.
- Zařízení se montuje svisle (nikoli nakloněné, vzhůru nohama ani položené).
- I po sestavení je zabezpečený snadný přístup.

Související ilustrace



Na konci tohoto dokumentu se nacházejí ilustrace doplňující různé níže uvedené části.

1.2 Bytová stanice



POZNÁMKA!

Rozměry jsou uvedeny na rozměrových výkresech. Všechny rozměry jsou v mm.

1. Označte místa, kde budete vrtat otvory.
2. Vyvrtejte otvory.
3. Upevněte stanici na stěnu pomocí dodaného materiálu.

1.3 Součásti

Filtr



Upozornění!

Před jakoukoli prací se sítkem uzavřete přívod vody do jednotky a uvolněte tlak.

Filtr zachycuje nečistoty a je možné ho vyndat a zkontrolovat nebo vyčistit.

Mezikus pro měřič tepla



POZNÁMKA!

Distanční kusy nejsou vhodné k nepřetržitému provozu.

Oběhové čerpadlo



POZNÁMKA!



Při použití pro podlahové vytápění se doporučuje, aby čerpadlo běželo pod konstantním tlakem. Tovární nastavení čerpadla není nastaveno na konstantní tlak, proto je nutno nastavení změnit

Čerpadlo (Grundfos UPM3) musí být nastaveno na režim konstantního tlaku ($\Delta p-c$), pak lze zajistit optimální provoz systému podlahového vytápění.

Nastavení se provádějí na čerpadle dle popisu v návodu k instalaci a obsluze.



CZ

1.4 Hydraulická instalace

	Výstraha! Netěsnící připojení může způsobit zranění osob a škody na majetku.
	POZNÁMKA! Nainstalujte potrubí dle popisu v projektové dokumentaci.

Propojte primární přívodní potrubí s odpovídajícími 3/4" kulovými ventily na stanici.



1.5 Elektrická instalace

	Výstraha! Požadované práce musí provést kvalifikovaný instalační technik v souladu s místními předpisy. To zahrnuje elektrické přípojky a instalace, nastavené pro provoz a údržbu.
	Výstraha! Zajistěte vyrovnání potenciálů pomocí měděného vodiče (průřez alespoň 6 mm ²). Připojte uzemňovací svorku k vhodné liště pro vyrovnání potenciálů v budově.

1.6 Plnění a vyplachování

Naplňte systém a propláchněte jej podle platných předpisů a norem.

1.7 Zkouška těsnosti

	Výstraha! Netěsnící připojení může způsobit zranění osob a škody na majetku.
	Upozornění! K úniku tlaku může dojít i při normálním provozním tlaku a je nutné jej okamžitě opravit.



Minimálně 2 h



Podle místních norem a předpisů

1.8 Dokončení instalace a předání

	Upozornění! Nesprávné provedení instalace může způsobit poškození majetku.
---	--







Postupujte podle těchto pokynů a dokončete instalaci:

1. Zkontrolujte nastavení.

2. Vyplňte protokol o převzetí/dokončení.
3. Přeďte dokumentaci a protokol majiteli domu.

1 Installation

1.1 Generel information

	Advarsel! Risiko for elektrisk stød ved berøring af komponenterne! Enheden kører med en 230 V-vekselstrømspænding.
	Advarsel! Risiko for elektrisk stød! Elektrisk installation og service service bag sikrede 230 V vekselstrømsafskærmninger skal udføres af en autoriseret elektriker.
	Advarsel! Uponor-systemet bruger 230 V vekselspænding, 50 Hz. Afbryd omgående strømmen i nødstilfælde.
	Advarsel! Forud for alt arbejde på kontrolenheden eller de komponenter, der er tilsluttet den, skal kontrolenheden slukkes i henhold til bestemmelserne.
	Advarsel! Fittings er under tryk. Udslip af trykmedier kan forårsage alvorlig personskade som skoldning eller øjenskade. Udlign trykket i systemet inden installationen udføres. Ved efterinstallation på et eksisterende system: Tøm systemet, eller luk for sektionens forsyningsledninger, og udlign trykket.
	Advarsel! Risiko for personskade på grund af enhedens tunge vægt: Udfør ikke installationen alene. Bær altid sikkerhedssko under monteringen. Unitten kan have en betydelig vægt afhængigt af konfigurationen. Hvis installationsskabet vælter, kan det medføre personskade, særligt beskadigelse af fødderne.
	Forsigtig! Lækager kan forekomme i enheden under transport eller installation. Kontroller omløbere for at sikre, at de er spændt ordentligt inden den forbindes for at undgå materielle skader.

Inden installation af varmeunitten skal det sikres, at:

- de primære rør er installeret på byggepladsen.
- den primære rørintallation er skyllet igennem og kontrolleret for lækager
- strøm- og jordkablerne er først til installationsstedet.
- enheden installeres i et tørt og frostfrit rum med en omgivelsestemperatur på mindre end +40 °C.
- unitten er monteret lodret (ikke skråt, på hovedet eller liggende).
- unitten altid er let tilgængelig, selv efter samlingen.

Relaterede illustrationer



Illustrationer relateret til de forskellige afsnit nedenfor er tilgængelige i slutningen af dette dokument.

1.2 Varmebetjeningsenheden

	BEMÆRK! Se måltetegninger for målinger. Alle mål er angivet i mm.
---	---

1. Markér, hvor hullerne skal bores.
2. Bor hullerne.
3. Fastgør unitten til væggen ved hjælp af de medfølgende skruer.

1.3 Komponenter

Si

	Forsigtig! Luk for vandforsyningen til enheden og aflast trykket, før der udføres arbejde på sien.
---	--

Sien opsamler snavs, og dens filter kan tages ud, så det kan undersøges og rengøres.

Måler pasrør til varmemåler

	BEMÆRK! Pasrøret er ikke egnede til kontinuerlig drift.
---	---

Cirkulationspumpe varme

	BEMÆRK! Det anbefales, at pumpen kører ved konstant tryk, når den bruges til gulvvarme. Pumpens fabriksindstilling er ikke indstillet til konstant tryk og skal derfor ændres
---	---

Pumpen (Grundfos UPM3) skal indstilles til konstant trykmodus ($\Delta p-c$) for at muliggøre optimal drift af gulvvarmesystemet.

Indstillingerne udføres på pumpehuset som beskrevet i installations- og betjeningsvejledningen.

1.4 Hydraulisk installation

	Advarsel! Utætte samlinger kan forårsage personskade og ejendomsskader.
---	---

	BEMÆRK! Installer rørene i overensstemmelse med planlægningsdokumentationen.
---	--

Tilslut de primære forsyningsledninger til de tilsvarende 3/4" kugleventiler på unitten.

1.5 Elektrisk installation

	Advarsel! Nødvendigt arbejde skal udføres af en kvalificeret installatør i overensstemmelse med lokale regler. Dette omfatter elektriske tilslutninger og installationer, opsat til drift og vedligeholdelse.
---	---

	Advarsel! Etabler potentialudligning ved hjælp af en potentialudligningsleder i kobber (tværsnit på mindst 6 mm ²). Tilslut jordklemmen til en passende potentialudligningsskinne i bygningen.
---	--

1.6 Påfyldning og gennemskyling

Påfyld og gennemskyl systemet ifølge lokale regulativer og standarder.

1.7 Tæthedstest

	Advarsel! Utætte samlinger kan forårsage personskade og ejendomsskader.
---	---

	Forsigtig! Tryk lekager kan forekomme, selv ved normalt driftstryk, og skal straks reparereres.
---	---

	Minimum 2 timer
---	-----------------

	I henhold til lokale regler og standarder
---	---

1.8 Afslutning af installationen og overlevering

	Forsigtig! Forkert afslutning af installationen kan medføre skader på ejendommen.
---	---

Følg disse trin og afslut installationen:

1. Kontroller indstillingerne.
2. Udfyld funktions-/indreguleringsrapport.
3. Overdrag dokumentationen og indreguleringsrapporten til slutbrugeren.

1 Instalación

1.1 Información general

	Advertencia: ¡Riesgo de descarga eléctrica por contacto directo! La unidad funciona con una tensión de 230 V de AC.
	Advertencia: Riesgo de descarga eléctrica. La instalación y el mantenimiento eléctrico de elementos protegidos con tapas y que funcionen a 230 V CA se debe llevar a cabo bajo la supervisión de un electricista cualificado.
	Advertencia: Fuente de alimentación del sistema Uponsor: 230 V CA, 50 Hz. En caso de emergencia, desconecte inmediatamente la alimentación.
	Advertencia: Antes de cualquier trabajo en la unidad o en los componentes conectados a ella, desconecte la unidad de acuerdo con la normativa.
	Advertencia: Los accesorios están bajo presión. El escape a presión puede provocar lesiones graves, como quemaduras o daños en los ojos. Quite presión en el sistema antes de realizar cualquier trabajo de instalación. Para actualizaciones en un sistema existente: Vacíe el circuito, cierre líneas de suministro y quite presión.
	Advertencia: Riesgo de lesiones debido al peso elevado de la unidad: No realice la instalación solo. Use siempre zapatos de seguridad durante el montaje. La unidad puede tener un peso considerable, dependiendo de la configuración. Si la estación se cae, esto podría conllevar lesiones, particularmente en los pies.
	Precaución: Pueden producirse fugas en la unidad durante el transporte o la instalación. Verifique las tuercas para asegurarse de que estén bien apretadas antes de la conexión para evitar daños a la propiedad.

Antes de instalar la unidad Combi Port, asegúrese que:

- Las tuberías están instaladas en la obra.
- La instalación de las tuberías están limpias y no hay fugas.
- Los cables suministro eléctrico y de toma tierra se tienden hasta el lugar de instalación.
- La unidad está instalada en una habitación seca y a salvo de heladas con una temperatura ambiente inferior a +40 °C.

- La unidad está montada en posición vertical (no inclinada, boca abajo ni de lado).
- La unidad presenta un fácil acceso, incluso después del montaje.

Iconografía



Existen iconos relacionados con las diferentes secciones al final de este documento.

1.2 Estación de transferencia de calor

	NOTA: Vea las dimensiones en los dibujos. Todas las medidas están en milímetros.
---	--

1. Marque dónde perforar los agujeros.
2. Taladre los agujeros.
3. Fije la estación HIU a la pared con el material proporcionado.

1.3 Componentes

Filtro

	Precaución: Cierre el suministro de agua a la unidad y libere la presión antes de realizar cualquier trabajo con el filtro.
---	---

El filtro retiene las posibles impurezas del agua, puede ser extraído para su inspección y limpieza.

Distanciador para contador de energía.

	NOTA: Las piezas distanciadoras no son adecuadas para un funcionamiento continuo.
---	---



Bomba de calefacción

	NOTA: Se recomienda que la bomba funcione a presión constante cuando se utiliza para calefacción por suelo radiante. El ajuste de fábrica de la bomba no está ajustado a presión constante y, por lo tanto, debe cambiarse.
---	---

La bomba (Grundfos UPM3) debe ajustarse al modo de presión constante (Δp -c) para permitir un funcionamiento óptimo del sistema de calefacción por suelo radiante.



Los ajustes de la bomba están descritos en el manual de instalación y funcionamiento.

1.4 Instalación hidráulica.

	Advertencia: Las fugas pueden causar lesiones personales y daños a la propiedad.
	NOTA: Instale las tuberías de acuerdo con la documentación del proyecto.

Conecte las líneas de suministro principal con las correspondientes válvulas de bola de 3/4" en la estación HIU.



1.5 Instalación eléctrica



	Advertencia: El trabajo requerido debe ser realizado por un instalador cualificado de acuerdo con las regulaciones locales. Esto incluye las conexiones e instalaciones eléctricas, preparadas para su operación y mantenimiento.
	Advertencia: Establezca la conexión equipotencial utilizando un conductor de conexión equipotencial de cobre (sección transversal de 6 mm ² como mínimo). Conecte la pinza de toma de tierra a un rail de conexión equipotencial adecuado en el edificio.

1.6 Llenado y purgado

El llenado y purgado debe realizarse conforme a la normativa local.

1.7 Prueba de estanqueidad

	Advertencia: Las fugas pueden causar lesiones personales y daños a la propiedad.
	Precaución: Las fugas de presión pueden ocurrir incluso a la presión de funcionamiento normal y deben repararse de inmediato.

	Mínimo 2 horas.
	Conforme a la normativa local.

1.8 Finalización y entrega de la instalación

	Precaución: Un acabado incorrecto de la instalación puede provocar daños materiales.
---	--

Siga estos pasos y finalice la instalación:

1. Compruebe la configuración.
2. Complete el protocolo de aceptación/finalización.
3. Entregue la documentación y el protocolo al propietario de la vivienda.

ES

1 Postavljanje

1.1 Opće informacije

	Upozorenje! Opasnost od strujnog udara ako dodirnete komponente! Jedinica radi pod naponom od 230 V AC.
	Upozorenje! Opasnost od električnog udara! Električne instalacije i servis iza zaštićenih poklopaca za izmjeničnu struju napona od 230 V moraju se obavljati pod nadzorom kvalificiranoga električara.
	Upozorenje! Napajanje sustava tvrtke Uponor: 230 V AC, 50 Hz. U hitnim slučajevima odmah isključite napajanje.
	Upozorenje! Prije bilo kakvih radova na regulatoru ili komponentama povezanim s njim, isključite regulator prema propisima.
	Upozorenje! Spojnice su pod tlakom. Izlazak medija pod tlakom može uzrokovati ozbiljne ozljede kao što su opekline ili ozljede oka. Spustite tlak u sustavu prije izvođenja bilo kakvih instalacijskih radova. Za naknadne ugradnje na postojeći sustav: Ispraznite sustav ili zatvorite dovodne vodove sekcije i spustite tlak.
	Upozorenje! Opasnost od ozljeda zbog velike težine jedinice: Ne izvodite instalaciju sami. Tijekom sastavljanja uvijek nosite zaštitnu obuću. Jedinica može biti poprilično teška, ovisno o konfiguraciji. Ako se stanica prevrne, to može dovesti do ozljeda, osobito stopala.
	Oprez! Tijekom transporta ili instalacije može doći do curenja u jedinici. Provjerite matice kako biste bili sigurni da su pravilno zategnute prije spajanja kako biste izbjegli oštećenje imovine.

Prije instalacije toplinske podstanice osigurajte:

- da su primarne cijevi položene prilikom gradnje,
- da su postavljene primarne cijevi isprane i da je provjereno da ne propuštaju,
- da su kabeli za napajanje i uzemljenje provedeni do mjesta instalacije,
- da je jedinica instalirana u suhoj prostoriji zaštićenoj od smrzavanja s temperaturom okoline nižom od +40 ° C,
- da je jedinica postavljena uspravno (ne nagnuto, naopako ili položeno),

- da se jedinici uvijek može lako pristupiti, čak i nakon sastavljanja.

Povezane ilustracije



Ilustracije koje se odnose na različite odjeljke u nastavku dostupne su na kraju ovog dokumenta.

1.2 Toplinska podstanica



NAPOMENA!

Mjere pogledajte na crtežima s dimenzijama. Sve dimenzije su izražene u mm.

1. Označite gdje ćete izbušiti rupe.
2. Izbušite rupe.
3. Pričvrstite toplinsku podstanicu na zid pomoću priloženog materijala.

1.3 Komponente

Hvatač nečistoća



Oprez!

Prije bilo kakvih radova na hvataču nečistoća zatvorite dovod vode u jedinicu i spustite tlak.

Hvatač nečistoća skuplja prijavštinu i njegov unutarnji filter se može ukloniti radi pregleda i čišćenja.

Distancer za mjerilo utroška toplinske energije



NAPOMENA!

Distanceri nisu prikladni za kontinuirani rad.

Toplinska pumpa





NAPOMENA!

Preporuča se da pumpa radi s konstantnim tlakom kada se koristi za podno grijanje. Tvornička postavka pumpe nije postavljena na konstantan tlak i stoga se mora promijeniti

Pumpa (Grundfos UPM3) mora biti postavljena na režim konstantnog tlaka ($\Delta p-c$) kako bi se omogućio optimalan rad sustava podnog grijanja.



Postavke se podešavaju na kućištu pumpe prema uputama opisanim u priručniku za postavljanje i rad.

1.4 Hidraulička instalacija

	Upozorenje! Curenje može uzrokovati ozljede i materijalnu štetu.
	NAPOMENA! Postaviti cijevi u skladu s planskom dokumentacijom.

Spojite primarne dovodne vodove s odgovarajućim kuglastim ventilima od ¾" na toplinsku podstanicu.



1.5 Električna instalacija

	Upozorenje! Potrebne radove mora obaviti stručni instalater u skladu s lokalnim propisima. To se odnosi na električne spojeve i instalacije, postavljanje proizvoda za rad i njegovo održavanje.
	Upozorenje! Uspostavite izjednačavanje potencijala pomoću bakrenog vodiča za izjednačavanje potencijala (poprečnog presjeka najmanje 6 mm ²). Spojite stezaljku za uzemljenje na odgovarajuću šinu za izjednačavanje potencijala u zgradi.

1.6 Punjenje i ispiranje

Napunite i isperite sustav u skladu s lokalnim propisima i normama.

1.7 Ispitivanje nepropusnosti

	Upozorenje! Curenje može uzrokovati ozljede i materijalnu štetu.
	Oprez! Može doći do curenja tlaka čak i pri normalnom radnom tlaku i to se mora odmah sanirati.



Minimalno 2 sata



U skladu s lokalnim normama i propisima

1.8 Završetak montaže i primopredaja

	Oprez! Pogrešni završni radovi na instalaciji mogu dovesti do oštećenja imovine.
---	--

Slijedite ove korake da završite instalaciju:







1. Provjerite postavke.
2. Ispunite protokol prijema/završetka.
3. Predajte dokumentaciju i protokol kućevlasniku.

Aqua/ Combi Port M-INS, Combi Port E-INS

Rövid szerelési útmutató

1 Telepítés

1.1 Általános információk

	Vigyázat! Áramütés veszélye az alkatrészek érintésekor! A készülék 230 V váltóáramú feszültséggel működik.
	Vigyázat! Áramütés veszélye! A 230 V-os váltóáram ellen védő biztonsági burkolat mögött villanszerelést és ehhez kapcsolódó szolgáltatást szakképzett villanszerelő felügyelete mellett kell végezni.
	Vigyázat! Az Uponor rendszer tápellátása: 230 V AC, 50 Hz. Veszély esetén azonnal szüntesse meg a tápellátást.
	Vigyázat! A vezérlőn vagy a hozzá csatlakoztatott alkatrészekon végzett munkálatok előtt az előírásoknak megfelelően kapcsolja ki a vezérlőt.
	Vigyázat! Az idomok nyomás alatt vannak. A nyomás alatt lévő közeg kiszabadulása súlyos sérüléseket, például leforrázást vagy szemsérülést okozhat. A szerelési munkálatok elvégzése előtt nyomástalanítsa a rendszert. Meglévő rendszerbe való beszereléshez: Engedje le a rendszert, vagy zárja el a szakasz tápvezetékeit, és nyomástalanítsa azt.
	Vigyázat! Sérülésveszély az egység nagy súlya miatt: Ne végezze a telepítést egyedül. Az összeszerelés során mindig viseljen biztonsági cipőt. Az egység a konfigurációtól függően jelentős súlyú lehet. Ha az egység felborul, az sérülésekhez vezethet, különösen lábtájékon.
	Figyelem! A szállítás vagy telepítés során szivárgás jelentkezhet az egységben. A csatlakoztatás előtt ellenőrizze az anyák megfelelő meghúzását az anyagi károk elkerülése érdekében.

A hőközponti egység beszerelése előtt győződjön meg arról, hogy:

- Az elsődleges csövek le vannak fektetve.
- Az elsődleges csőszerelvényt átöblítették és ellenőrizték szivárgásra.
- A táp- és földkábelek a telepítés helyére vannak vezetve.
- Az egységet száraz és fagymentes helyiségben, +40 °C-nál alacsonyabb környezeti hőmérsékleten lehet elhelyezni.
- az egységet függőlegesen (nem ferdén, fejjel lefelé vagy felfelé) lehet felszerelni.

- Az egységhez mindig könnyen hozzá lehessen férni, még az összeszerelés után is.

Kapcsolódó illusztrációk



Az alábbi szakaszokhoz kapcsolódó illusztrációk a dokumentum végén találhatóak.

1.2 Hőközponti egység



MEGJEGYZÉS

A méretekért lásd a méretrajzokat. Minden méret mm-ben van megadva.

1. Jelölje meg, hol kell lyukakat fúrni.
2. Fúrja ki a lyukakat.
3. Rögzítse a HIU-t a falra a mellékelt anyag segítségével.

1.3 Alkatrészek

Szűrő



Figyelem!

Zárja el az egység vízellátását, és szüntesse meg a nyomást, mielőtt bármilyen munkát végezne a szűrővel.

A szűrő összegyűjti a szennyeződések, és a filter ellenőrzés és tisztítás céljából kivehető.

Hőmennyiség mérő távtartó darab



MEGJEGYZÉS

A távtartó darabjai nem alkalmasak folyamatos használatra.

Fűtőszivattyú



MEGJEGYZÉS



Javasoljuk, hogy a szivattyú állandó nyomáson működjön, ha padlófűtéshez használják. A szivattyú gyári beállítása nem állandó nyomásra van beállítva, ezért azt meg kell változtatni.

A szivattyút (Grundfos UPM3) állandó nyomási módra ($\Delta p-c$) kell beállítani, hogy a padlófűtési rendszer optimálisan működjön.

A beállításokat a szivattyúházból az üzembe helyezési és használati kézikönyvben leírtak szerint kell elvégezni.



HU

1.4 Hidraulikus telepítés

	Vigyázat! A szivárgások személyi sérülést és anyagi károkat okozhatnak.
	MEGJEGYZÉS A csöveket a tervezési dokumentációnak megfelelően szerelje fel.

Csatlakoztassa az elsődleges tápvezetékeket a megfelelő 3/4"-es golyóscsapokhoz a HIU-nál.



1.5 Villanszerelés

	Vigyázat! A szükséges munkálatokat a helyi előírásoknak megfelelően, képzett kivitelezőnek kell elvégeznie. Ide tartozik az elektromos csatlakozások kialakítása, a telepítés, az üzembe helyezés és a karbantartás is.
	Vigyázat! Hozzon létre potenciálkiegyenlítést réz potenciálkiegyenlítő vezetővel (legalább 6 mm ² -es keresztmetszet). Csatlakoztassa a földelőbilincset egy megfelelő potenciálkiegyenlítő sínhez az épületben.

1.6 Töltés és öblítés

Töltse fel és öblítse át a rendszert a helyi előírásoknak és szabványoknak megfelelően.

1.7 Nyomáspróba

	Vigyázat! A szivárgások személyi sérülést és anyagi károkat okozhatnak.
	Figyelem! Nyomásszivárgás még normál üzemi nyomáson is előfordulhat, és azt azonnal meg kell javítani.



Minimum 2 óra



A helyi szabványok és előírások szerint

1.8 A telepítés befejezése és átadás







	Figyelem! A telepítés nem megfelelő befejezése anyagi károkhoz vezethet.
---	--

Kövesse ezeket a lépéseket és fejezze be a telepítést:

1. Ellenőrizze a beállításokat.
2. Töltse ki az átvételi/befejezési jegyzőkönyvet.
3. Adja át a dokumentációt és a jegyzőkönyvet a lakástulajdonosnak.

1 Montaż

1.1 Informacje ogólne

	Ostrzeżenie! Ryzyko porażenia prądem w przypadku dotknięcia elementów! Napięcie robocze urządzenia wynosi 230 V (prąd przemienny).
	Ostrzeżenie! Ryzyko porażenia prądem! Montaż instalacji elektrycznej i serwis elementów znajdujących się pod zabezpieczającymi pokrywami 230 V AC należy przeprowadzać pod nadzorem wykwalifikowanego elektryka.
	Ostrzeżenie! Zasilanie systemu Uponor: 230 V AC, 50 Hz. W razie zagrożenia należy natychmiast wyłączyć zasilanie.
	Ostrzeżenie! Przed przystąpieniem do jakichkolwiek prac przy sterowniku lub podłączonych do niego elementach należy wyłączyć sterownik zgodnie z przepisami.
	Ostrzeżenie! Kształtki są pod ciśnieniem. Wyciek czynnika grzewczego pod ciśnieniem może spowodować poważne obrażenia, takie jak poparzenie lub uszkodzenie wzroku. Przed przystąpieniem do jakichkolwiek prac montażowych należy rozszczelnić system. W przypadku modernizacji istniejącego systemu: opróżnić system lub zamknąć przewody zasilające sekcji i spuścić z niej ciśnienie.
	Ostrzeżenie! Ryzyko obrażeń z powodu dużego ciężaru stacji: nie wykonywać instalacji samodzielnie. Podczas montażu zawsze nosić obuwie ochronne. W zależności od konfiguracji urządzenie może być ciężkie. Jeśli stacja przewróci się, może to doprowadzić do obrażeń, zwłaszcza stóp.
	Przeostroga! Podczas transportu lub instalacji może dojść do rozszczelnienia urządzenia. Przed połączeniem sprawdzić nakrętki i upewnić się, że są odpowiednio dokręcone, aby uniknąć szkód materialnych.

Przed zainstalowaniem programatora ogrzewania upewnić się, że:

- rury obiegu pierwotnego są ułożone w budynku;
- rury obiegu pierwotnego są przepłukane i sprawdzona pod kątem wycieków;
- kable zasilające i uziemiające są doprowadzone do miejsca instalacji;
- stację montuje się w suchym i wolnym od przymrozków pomieszczeniu o temperaturze otoczenia poniżej 40°C;

- stację montuje się w pozycji pionowej (nie w nachyleniu, nie do góry nogami, ani w pozycji leżącej);
- dostęp do urządzenia jest zawsze łatwy, nawet po montażu.

Powiązane ilustracje



Ilustracje odnoszące się do różnych sekcji poniżej są dostępne na końcu tego dokumentu.

1.2 Stacja mieszkaniowa

	UWAGA! Wymiary znajdują się na rysunkach technicznych. Wszystkie wymiary podano w mm.
---	---

1. Oznaczyć, gdzie należy wywiercić otwory.
2. Wywiercić otwory.
3. Przymocować stację mieszkaniową (HIU) do ściany za pomocą dostarczonych elementów montażowych.

1.3 Elementy

Filtr

	Przeostroga! Przed przystąpieniem do jakichkolwiek prac z filtrem należy odciąć dopływ wody do urządzenia i obniżyć ciśnienie.
---	--

Filtr zbiera zanieczyszczenia i można go wyjąć w celu sprawdzenia i oczyszczenia.

Element dystansowy licznika ciepła

	UWAGA! Elementy dystansowe nie nadają się do pracy ciągłej.
---	---



Pompa grzewcza

	UWAGA! W przypadku ogrzewania podłogowego zaleca się, aby pompa pracowała ze stałym ciśnieniem (stałą wysokością podnoszenia). Ustawienie fabryczne pompy nie jest ustawione na stałe ciśnienie, w związku z czym należy je zmienić.
---	--

Pompa (Grundfos UPM3) musi być ustawiona na tryb stałego ciśnienia, stałej wysokości podnoszenia ($\Delta p-c$), aby umożliwić optymalną pracę systemu ogrzewania podłogowego.



Ustawień dokonuje się w pompie w sposób opisany poniżej.

1.4 Instalacja hydrauliczna

	Ostrzeżenie! Nieszczelności mogą spowodować obrażenia ciała i szkody materialne.
	UWAGA! Zainstalować rury zgodnie z dokumentacją projektową.

Połączyć główne przewody zasilające stacji mieszkaniowej (HIU) z odpowiednimi zaworami kulowymi 3/4".



1.5 Instalacja elektryczna

	Ostrzeżenie! Wymagane prace muszą być wykonane przez wykwalifikowanego instalatora zgodnie z lokalnymi przepisami. Obejmuje to połączenia i instalacje elektryczne, przygotowane do eksploatacji i konserwacji.
	Ostrzeżenie! Zapewnić wyrównanie potencjałów za pomocą miedzianego przewodu (przekrój co najmniej 6 mm ²). Podłączyć zacisk uziemiający do odpowiedniej szyny wyrównania potencjałów w budynku.

1.6 Napełnianie i płukanie

Napełnić i przepłukać system zgodnie z lokalnymi przepisami i normami.

1.7 Próba szczelności

	Ostrzeżenie! Nieszczelności mogą spowodować obrażenia ciała i szkody materialne.
	Przeostroga! Nieszczelności mogą wystąpić nawet przy normalnym ciśnieniu roboczym i należy je natychmiast naprawić.



Minimum 2 godziny



Zgodnie z lokalnymi normami i przepisami

1.8 Zakończenie montażu i przekazanie







	Przeostroga! Nieprawidłowe zakończenie montażu może prowadzić do szkód materialnych.
---	--

Wykonać następujące kroki i zakończyć instalację:

1. Sprawdzić ustawienia.
2. Uzupelnąć protokół odbioru/zakończenia.
3. Przekazać dokumentację i protokół właścicielowi domu.

1 Instalação

1.1 Informações gerais

	Aviso! Risco de choque elétrico se tocar nos componentes! A unidade funciona com uma tensão de 230 V CA.
	Aviso! Risco de choque elétrico! A instalação elétrica e a manutenção de componentes localizados no interior de coberturas de 230 VCA fechadas têm de ser executadas sob supervisão de um electricista qualificado.
	Aviso! Fonte de alimentação do sistema Uponor: 230 VCA, 50 Hz. Em caso de emergência, desligue imediatamente a alimentação elétrica.
	Aviso! Antes de manipular de qualquer forma o controlador ou os componentes ligados ao mesmo, desligue-o de acordo com os regulamentos.
	Aviso! Os acessórios estão sob pressão. A fuga de matéria pressurizada pode causar danos graves, como queimaduras e lesões oculares. Despressurize o sistema antes de realizar qualquer trabalho de instalação. Para adaptações a um sistema existente: Esvazie o sistema ou feche as linhas de alimentação da secção e despressurize-a.
	Aviso! Risco de lesão devido ao peso elevado da unidade: Não execute a instalação sozinho. Utilize sempre calçado de segurança durante a montagem. A unidade pode ter um peso considerável, dependendo da configuração. Se a estação cair, pode provocar lesões, especialmente nos pés.
	Cuidado! Podem ocorrer derrames na unidade durante o transporte ou instalação. Verifique as porcas para garantir que estejam devidamente apertadas antes da conexão para evitar danos materiais.

Antes de instalar a unidade de interface de calor, certifique-se de que:

- os tubos principais são colocados no local da obra.
- a instalação do tubo principal é lavada e verificada quanto a fugas
- os cabos de alimentação e terra são encaminhados para o local de instalação.
- a unidade é instalada num ambiente seco e sem gelo, com uma temperatura ambiente inferior a +40 °C.

- a unidade é montada na vertical (não inclinada, invertida ou deitada).
- o acesso à unidade é sempre fácil, mesmo depois da montagem.

Ilustrações relacionadas



As ilustrações relacionadas com as diferentes secções abaixo estão disponíveis no final deste documento.

1.2 Unidade de interface de calor

	NOTA! Consulte os desenhos dimensionais para as medições. Todas as dimensões são expressas em milímetros.
---	---

1. Marque onde fazer os furos.
2. Faça os furos.
3. Fixe a HIU na parede utilizando o material fornecido.

1.3 Componentes

Ralo

	Cuidado! Desligue o abastecimento de água da unidade e alivie a pressão antes de qualquer operação no ralo.
---	---

O ralo recolhe sujidade e o respetivo filtro pode ser removido para inspeção e limpeza.

Peça de distância do contador de calor

	NOTA! As peças distanciadoras não são adequadas para funcionamento contínuo.
---	--

Bomba de aquecimento

	NOTA! Recomenda-se que a bomba funcione a pressão constante quando utilizada para chão radiante. A definição de fábrica da bomba não está definida para pressão constante e, portanto, tem de ser alterada
---	--

A bomba (Grundfos UPM3) tem de ser regulada para o modo de pressão constante ($\Delta p-c$) para permitir um funcionamento ideal do sistema de chão radiante.

As configurações são feitas na casa das bombas conforme descrito no manual de instalação e operação.

1.4 Instalação hidráulica

	Aviso! Os derrames podem causar ferimentos pessoais e danos materiais.
---	--

	NOTA! Instale os tubos de acordo com os documentos de planeamento.
---	--

Ligue as linhas de alimentação principal às válvulas esfera de 3/4" correspondentes na HIU.

1.5 Instalação elétrica

	Aviso! O trabalho necessário tem de ser realizado por um instalador qualificado de acordo com os regulamentos locais. Isto inclui as ligações e as instalações elétricas, preparadas para operação e manutenção.
---	--

	Aviso! Estabeleça a ligação equipotencial utilizando um condutor de ligação equipotencial de cobre (secção transversal de pelo menos 6 mm ²). Conecte o grampo de ligação à terra a uma calha de ligação equipotencial adequada no edifício.
---	--

1.6 Enchimento e lavagem

Encha e lave o sistema de acordo com os regulamentos e normas locais.

1.7 Teste de estanquicidade

	Aviso! Os derrames podem causar ferimentos pessoais e danos materiais.
---	--

	Cuidado! Podem ocorrer derrames de pressão mesmo com pressão operacional normal e devem ser reparados imediatamente.
---	--



Mínimo de 2 horas



De acordo com os regulamentos e normas locais

1.8 Concluir a instalação e entrega







	Cuidado! O acabamento incorreto da instalação pode causar danos materiais.
---	--

Siga estes passos e conclua a instalação:

1. Verifique as configurações.
2. Preencha o protocolo de aceitação/finalização.
3. Entregue a documentação e o protocolo ao proprietário.

1 Instalarea

1.1 Informații generale

	Avertisment! Risc de electrocutare în cazul atingerii componentelor! Unitatea funcționează cu o tensiune de 230 V c.a.
	Avertisment! Risc de electrocutare! Instalarea și revizia sistemelor electrice prevăzute cu capace de siguranță la 230 V c.a. trebuie să se efectueze sub supravegherea unui electrician calificat.
	Avertisment! Sursa de alimentare a sistemului Uponor: 230 V c.a., 50 Hz. În caz de urgență, deconectați imediat alimentarea electrică.
	Avertisment! Înainte de orice lucrări la unitatea de comandă sau la componentele conectate la aceasta, opriți unitatea de comandă conform reglementărilor.
	Avertisment! Fitingurile sunt sub presiune. Ieșirea agentului termic sub presiune poate produce răni grave, cum ar fi opărirea sau lezarea ochilor. Depresurizați sistemul înainte de a efectua orice lucrare de instalare. Pentru retehnologizarea unui sistem existent: Goliți sistemul sau închideți liniile de alimentare ale secțiunii și depresurizați-o.
	Avertisment! Pericol de rănire din cauza greutatei mari a unității: Nu efectuați instalarea singur. Purtați întotdeauna încălțăminte de protecție în timpul asamblării. Unitatea poate avea o greutate considerabilă, în funcție de configurație. În cazul în care stația cade, acest lucru ar putea duce la vătămări, în special la nivelul picioarelor.
	Atenție! În timpul transportului sau instalării pot apărea scurgeri în unitate. Verificați piulițele pentru a vă asigura că sunt strânse corespunzător înainte de conectare, pentru a evita daunele materiale.

Înainte de a instala unitatea de interfață termică, asigurați-vă că:

- conductele principale sunt amplasate în șantier.
- instalația de conducte principale este spălată și verificată pentru scurgeri
- cablurile de alimentare și de împământare sunt direcționate la locul de instalare.
- unitatea este instalată într-o încăpere uscată și ferită de îngheț, cu o temperatură ambientală mai mică de +40 °C.

- unitatea este montată vertical (nu înclinată, răsturnată sau culcată).
- unitatea este întotdeauna ușor de accesat chiar și după asamblare.

Ilustrații conexe



Ilustrațiile referitoare la diferitele secțiuni de mai jos sunt disponibile la sfârșitul acestui document.

1.2 Unitate interfață căldură

	NOTĂ! Consultați desenele dimensionale pentru măsurători. Toate dimensiunile sunt date în mm.
---	---

1. Marcați unde să dați găurile.
2. Dați găurile.
3. Fixați HIU pe perete folosind materialul furnizat.

1.3 Componente

Sită

	Atenție! Opriti alimentarea cu apă a unității și eliberați presiunea înainte de a lucra cu sita.
---	--

Sita colectează murdăria și filtrul său poate fi îndepărtat pentru inspecție și curățare.

Piesă distanțieră contor de căldură

	NOTĂ! Piesele distanțiere din plastic nu sunt potrivite pentru funcționare continuă.
---	--



Pompă de încălzire

	NOTĂ! Se recomandă ca pompa să funcționeze la presiune constantă atunci când este utilizată pentru încălzirea prin pardoseală. Setarea din fabrică a pompei nu este setată la presiune constantă și, prin urmare, trebuie modificată
---	--

Pompa (Grundfos UPM3) trebuie setată la modul de presiune constantă ($\Delta p-c$) pentru a permite o funcționare optimă a sistemului de încălzire prin pardoseală.



Setările sunt efectuate pe carcasa pompei așa cum este descris în manualul de instalare și operare.

1.4 Instalare hidraulică

	Avertisment! Scurgerile pot provoca vătămări corporale și pagube materiale.
	NOTĂ! Instalați conductele în conformitate cu documentația de planificare.

Conectați traseele de alimentare principale cu robinetii cu bilă de 3/4" corespunzătorii la HIU.



1.5 Instalare electrică

	Avertisment! Lucrările necesare trebuie efectuate de un instalator calificat, conform reglementărilor locale. Acestea includ realizarea conexiunilor și instalațiilor electrice, precum și pregătirea pentru operare și întreținere.
	Avertisment! Stabiliți o legătură echipotențială utilizând un conductor de cupru de legătură echipotențială (secțiune transversală de cel puțin 6 mm ²). Conectați clema de împământare la o șină de echipotențial adecvată din clădire.

1.6 Umplerea și spălarea

Umpleți și spălați sistemul în conformitate cu reglementările și standardele locale.

1.7 Teste de etanșeitate

	Avertisment! Scurgerile pot provoca vătămări corporale și pagube materiale.
	Atenție! Scurgerile de presiune pot apărea chiar și la presiunea normală de funcționare și trebuie reparate imediat.



Minimum 2 ore



Conform standardelor și reglementărilor locale

1.8 Finalizarea instalării și predarea

	Atenție! Finisarea incorectă a instalației poate duce la daune materiale.
---	---

Urmați acești pași și finalizați instalarea:

1. Verificați setările.
2. Completați procesul verbal de recepție/finalizare.
3. Predați documentația și protocolul proprietarului.

1 Vgradnja

1.1 Splošne informacije

	Opozorilo! Nevarnost električnega udara, če se dotaknete komponent! Enota deluje z napetostjo 230 V na izmenični tok.
	Opozorilo! Nevarnost električnega udara! Električna dela, ki se opravljajo za varovanim pokrovom 230 V AC predelka, je treba izvajati pod nadzorom usposobljenega električarja.
	Opozorilo! Napajanje sistema Uponor: 230 V AC, 50 Hz. V primeru nevarnosti takoj prekinite napajanje.
	Opozorilo! Pred delom na regulatorju ali komponentah, povezanih z njim, regulator izklopite v skladu s predpisi.
	Opozorilo! Fitingi so pod tlakom. Uhajanje medija pod tlakom lahko povzroči resne poškodbe, kot so opekline ali poškodbe oči. Pred vsakršnim posegom v toplotno postajo, znižajte tlak v sistemu. Za naknadne vgradnje v obstoječi sistem: Izpraznite sistem ali zaprite dovodne vode na ustreznem odseku in znižajte tlak.
	Opozorilo! Nevarnost poškodb zaradi velike teže toplotne postaje: Vgradnje ne opravljajte sami. Med montažo vedno nosite zaščitne čevlje. Toplotna postaja je lahko zelo težka, odvisno od konfiguracije. Če se toplotna postaja prevrne, lahko pride do poškodb, še posebej na stopalih.
	Pozor! Med prevažanjem ali vgradnjo lahko pride do puščanja v toplotni postaji. Pred priključitvijo preverite, ali so matice ustrezno zategnjene, da preprečite materialno škodo.

Pred vgradnjo toplotne postaje zagotovite da:

- so primarne cevi položene na gradbišču
- so vgrajene primarne cevi sprane in preverjene na vodotesnost
- so napajalni in ozemljitveni kabli speljani do mesta vgradnje
- da je toplotna postaja vgrajena v suhem prostoru, zaščitenem pred zmrzaljo, pri temperaturi okolice nižji od +40 °C
- je toplotna postaja nameščena pokončno (ni nagnjena, obrnjena na glavo ali v ležečem položaju).
- je toplotna postaja enostavno dostopna, tudi po montaži.

Povezane slike



Slike, povezane z različnimi spodnjimi razdelki, so na voljo na koncu tega dokumenta.

1.2 Toplotna postaja

	OPOMBA! Za mere glejte merske risbe. Vse mere so podane v milimetrih.
---	---

1. Označite, kje boste izvrtali luknje.
2. Izvrtajte luknje.
3. STP pritrdite na steno s priloženim materialom.

1.3 Komponente

Mrežasti filter

	Pozor! Pred vsakim delom z mrežastim filtrom zaprite dovod vode v postajo in znižajte tlak.
---	---

Mrežasti filter zbira umazanijo in ga je mogoče odstraniti za pregled in čiščenje.

Distančnik merilnika toplotne energije

	OPOMBA! Distančni kosi niso primerni za neprekinjeno delovanje.
---	---

Obtočna črpalka

	OPOMBA! Priporočljivo je, da črpalka deluje pri konstantnem tlaku, če se uporablja za talno ogrevanje. Tovarniška nastavitve črpalke ni nastavljena na konstantni tlak, zato jo je treba spremeniti
---	---

Črpalka (Grundfos UPM3) mora biti nastavljena na način konstantnega tlaka ($\Delta p - c$), da se omogoči optimalno delovanje sistema talnega ogrevanja.

Nastavitve se izvedejo na črpalci, kot je opisano v priročniku za montažo in uporabo.

1.4 Instalacija hidravličnega sistema

	Opozorilo! Če pride do puščanja, lahko to povzroči telesne poškodbe in materialno škodo.
---	--

	OPOMBA! Namestite cevi v skladu z dokumentacijo za načrtovanje.
---	---

Povežite primarne dovodne cevi z ustreznimi 3/4" krogelnimi ventili na STP.

1.5 Električna instalacija

	Opozorilo! Potrebna dela mora izvesti kvalificiran instalater v skladu z lokalno zakonodajo. Ta dela vključujejo priključevanje v električno omrežje, montažo, nastavitve za obratovanje in vzdrževanje.
---	--

	Opozorilo! Vzpostavite izenačitev potencialov z bakrenim prevodnikom za zaščitno izenačitev potencialov (prečni prerez najmanj 6 mm ²). Ozemljitveno objemko priključite na ustrezno letev za zaščitno izenačitev potencialov v zgradbi.
---	--

1.6 Polnjenje in izpiranje

Napolnite in izperite sistem v skladu z lokalnimi predpisi in standardi.

1.7 Preizkus tesnosti

	Opozorilo! Če pride do puščanja, lahko to povzroči telesne poškodbe in materialno škodo.
---	--

	Pozor! Do puščanja tlaka lahko pride tudi pri normalnem delovnem tlaku in to je treba takoj popraviti.
---	--



Najmanj 2 uri



V skladu z lokalnimi standardi in predpisi

1.8 Zaključek montaže in predaja

	Pozor! Nepravilno zaključena vgradnja lahko povzroči materialno škodo.
---	--

Za zaključek montaže upoštevajte spodnje korake:







1. Preglejte nastavitve.
2. Izpolnite protokol prevzema/zaključka.
3. Izročite dokumentacijo in protokol lastniku zgradbe.

Aqua/ Combi Port M-INS, Combi Port E-INS

Stručný návod

1 Montáž

1.1 Všeobecné informácie

	Výstraha! Nebezpečenstvo úrazu elektrickým prúdom pri dotýkaní sa komponentov! Jednotka pracuje so striedavým napätím 230 V.
	Výstraha! Nebezpečenstvo úrazu elektrickým prúdom! Montážne a servisné práce na elektrických systémoch za zabezpečeným krytím proti striedavému prúdu 230 V musia byť vykonané pod dohľadom kvalifikovaného elektrikára.
	Výstraha! Systém Uponor si vyžaduje napájanie zo siete 230 V AC, 50 Hz. V prípade núdze okamžite odpojte napájanie.
	Výstraha! Pred prácou na regulátore alebo jeho komponentoch sa ubezpečte, že je vypnutý podľa predpisov.
	Výstraha! Tvarovky sú pod tlakom. V prípade úniku teplotných látok, ktoré sú pod tlakom môže dôjsť k vážnemu poraneniu, ako napríklad obarenie alebo poranenie očí. Pred vykonaním akýchkoľvek servisných prác systém odzdušnite. Dodatočná montáž do existujúceho systému: Vypustíte systém alebo uzavrite prívody a odzdušnite ju.
	Výstraha! Vysoká hmotnosť stanice môže spôsobiť zranenie. Inštaláciu nevykonávajte osamote. Počas montáže vždy používajte bezpečnostnú obuv. Bytová stanica môže mať značnú váhu, v závislosti od jej výbavy. Pri páde môže stanica spôsobiť zranenia, predovšetkým poranenia nôh.
	Upozornenie! Počas prepravy alebo inštalácie môže dôjsť k netesnostiam v bytovej stanici. Pred pripojením skontrolujte, či sú matice správne dotiahnuté, aby sa predišlo škodám na majetku.

Pred inštaláciou bytovej stanice tepla sa uistite, že:

- Primárne potrubia sú namontované na stavbe.
- Primárne potrubia na stavbe sú prepláchnuté a skontrolované voči netesnostiam.
- V mieste inštalácie sú napájacie a uzemňovacie káble.
- Bytová stanica smie byť inštalovaná v suchom prostredí, v priestore chránenom voči mrazu, s teplotou nižšou ako +40 °C.
- Bytová stanica sa montuje zvislo (nesmie byť namontovaná šikmo, otočená smerom dolu ani v horizontálnej polohe).

- Aj po montáži a osadení musí byť zabezpečený jednoduchý prístup k bytovej stanici.

Súvisiace ilustrácie



Na konci tohto dokumentu sú k dispozícii príklady týkajúce sa rôznych sekcií uvedených nižšie.

1.2 Bytová stanica tepla

	POZNÁMKA! Rozmery sú uvedené na rozmerových výkresoch. Všetky rozmery sú uvedené v mm.
---	--

1. Označte, kde vyvŕtať otvory.
2. Vyvŕtajte otvory.
3. Upevnite HIU stanicu na stenu pomocou dodaného materiálu.

1.3 Komponenty

Filter

	Upozornenie! Pred akoukoľvek prácou so sitkom uzavrite prívod vody do zariadenia a uvoľnite tlak.
---	---

Filter zachytáva nečistoty a je možné ho vybrať, skontrolovať a vyčistiť.

Medzikus merača tepla

	POZNÁMKA! Medzikusy nie sú vhodné pre nepretržitú prevádzku.
---	--

Tepelné čerpadlo

	POZNÁMKA! Pri použití pre podlahové vykurovanie sa odporúča, aby čerpadlo pracovalo pri konštantnom tlaku. Výrobné nastavenie čerpadla nie je nastavené na konštantný tlak, a preto sa musí zmeniť
---	--

Čerpadlo (Grundfos UPM3) musí byť nastavené na režim konštantného tlaku ($\Delta p-c$), aby bola zabezpečená optimálna prevádzka systému podlahového vykurovania.

Nastavenia treba vykonať na čerpadle podľa popisu v návode na inštaláciu a prevádzku.

1.4 Pripojenia do hydraulického okruhu

	Výstraha! Netesnosti môžu spôsobiť zranenie osôb a škody na majetku.
---	--

	POZNÁMKA! Namontujte potrubia tak, ako je uvedené v projektovej dokumentácii.
---	---

Pripojte primárne prívodné potrubia s príslušnými 3/4" guľovými ventilmi na HIU.

1.5 Elektroinštalácia

	Výstraha! Požadovanú prácu musí vykonať kvalifikovaný inštalatér v súlade s miestnymi predpismi. To zahŕňa elektrické pripojenia a inštalácie, nastavené na prevádzku a údržbu.
---	---

	Výstraha! Vytvorte vyrovnanie potenciálov pomocou medeného vodiča vyrovnania potenciálov (prierez najmenej 6 mm ²). Pripojte uzemňovaciu svorku k vhodnej lište na vyrovnanie potenciálov v budove.
---	---

1.6 Napúšťanie a vypúšťanie

Naplňte a prepláchnite systém podľa miestnych predpisov a noriem.

1.7 Skúška tesnosti

	Výstraha! Netesnosti môžu spôsobiť zranenie osôb a škody na majetku.
---	--

	Upozornenie! K únikom a netesnostiam môže dochádzať aj pri normálnom prevádzkovom tlaku a musí sa okamžite opraviť.
---	---



Minimálne 2 hodiny



Podľa miestnych noriem a predpisov

1.8 Dokončenie inštalácie a odovzdanie

	Upozornenie! Nesprávne ukončenie inštalácie môže viesť k poškodeniu majetku.
---	--

Postupujte podľa týchto krokov a dokončite inštaláciu:

1. Skontrolujte nastavenia.
2. Vyplňte protokol o prijatí/dokončení do prevádzky.
3. Dokumentáciu a protokol odovzdajte majiteľovi nehnuteľnosti.



1.2

S80000335

Uponor Aqua Port M-INS

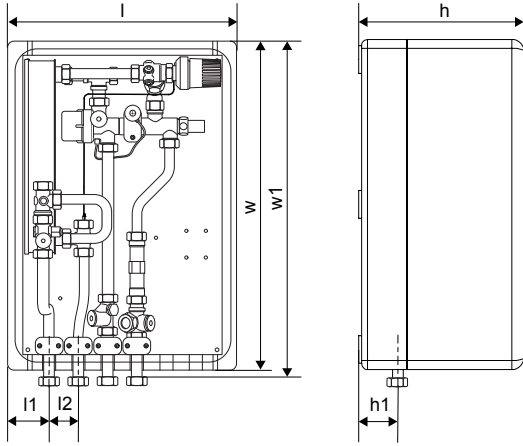

ZD0000072

l	l1	l2	w	w1
390 mm	70 mm	50 mm	560 mm	578 mm
h	h1			
280 mm	67 mm			

l	l1	l2	w	w1
390 mm	70 mm	50 mm	560 mm	578 mm
h	h1			
280 mm	67 mm			

Uponor Combi Port E-INS (underfloor heating) with circulation and Uponor Smatrix

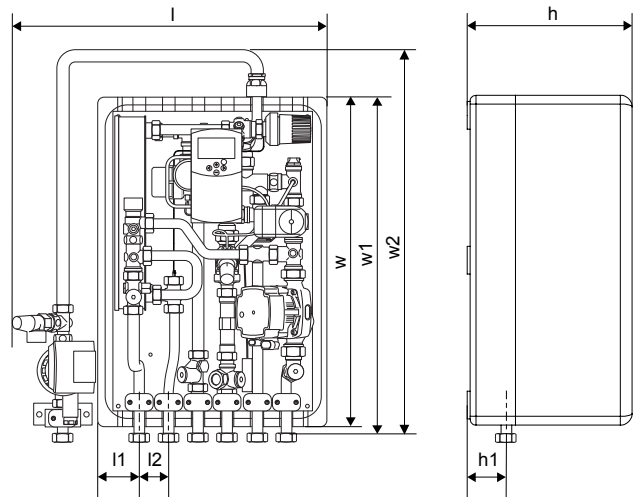

ZD0000070

l	l1	l2	w	w1
430 mm	70 mm	50 mm	560 mm	578 mm
w2	h	h1		
678 mm	280 mm	67 mm		

Uponor Combi Port M-INS (radiator connection)

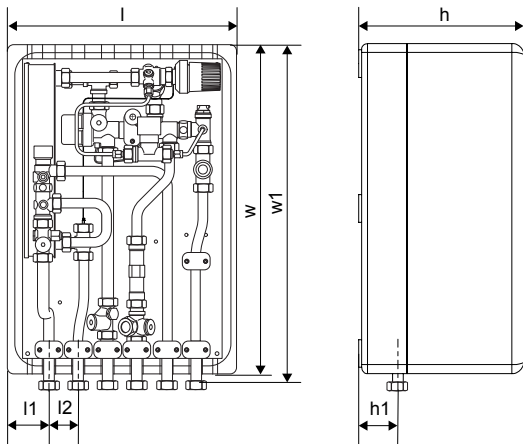

ZD0000071



1.2

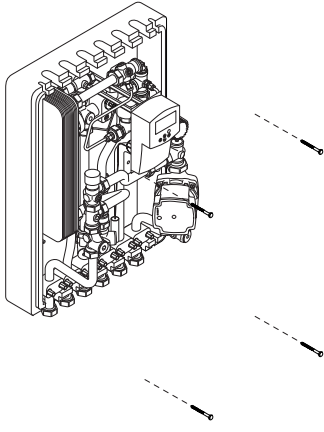

1.3 A

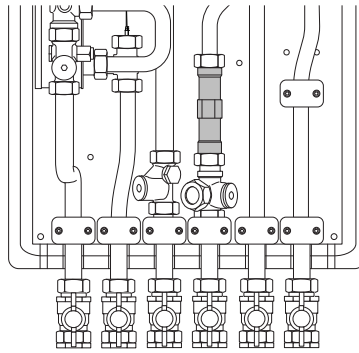

1.3 B

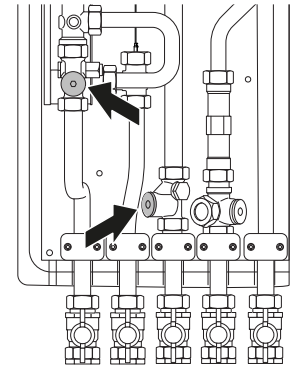

1.4

Uponor Combi Port M-/ E-INS

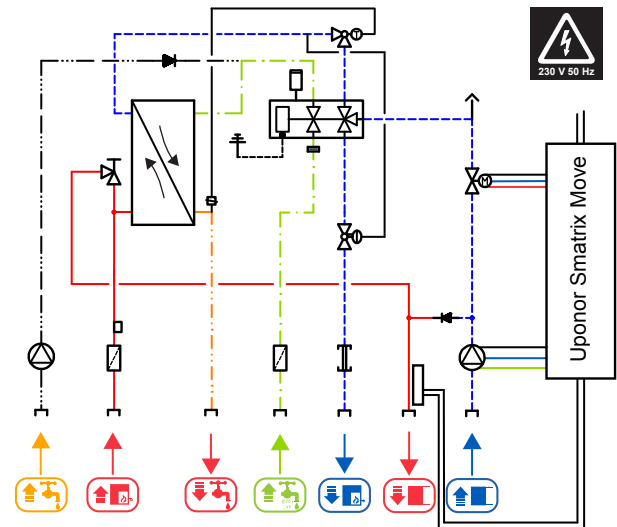
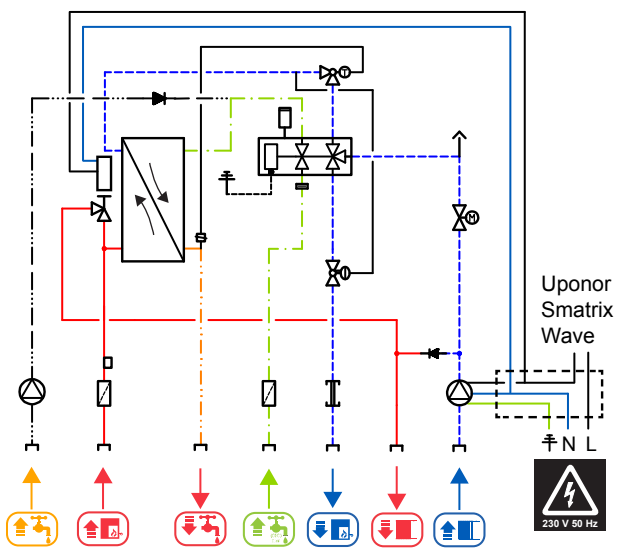

SI0000785

Uponor

Uponor GmbH

Industriestraße 56,
D-97437 Hassfurt, Germany

1143306 v1_12-2023_INT
Production: Uponor/ SDE

Uponor reserves the right to make changes, without prior notification,
to the specification of incorporated components in line with its policy of
continuous improvement and development.



www.uponor.com