

Silenta Premium

Sound-Insulated Piping Systems



+GF+



Table of Contents

| | |
|---|--------------|
| About GF Hakan Plastik | 4-5 |
| About Plastics | 6-7 |
| Certification Details | 8-9 |
| Silenta Premium-Sound Insulated Piping Systems | 10-17 |
| Packing, Stocking and Shipment | 18 |
| • Packaging | 19 |
| • Storage | 20 |
| • Transportation | 21 |
| Installation | 22 |

About Us





Founded in Switzerland in 1802, Georg Fischer Corporation operates in 3 main business lines: GF Piping Systems, GF Casting Solutions and GF Machining Solutions. Georg Fischer is present in 34 countries with 57 production plants and 136 companies.

GF Piping Systems, the largest business line of Georg Fischer Corporation, is one of the leading companies in plastic and metal piping systems in the world. GFPS produces system solutions and high quality components for the secure transmission of water and gas in industries, utilities and building technology. Reaching out to over 100 countries with its more than 30 production plants, GF Piping Systems acquired **Hakan Plastik** in 2013.

Founded in 1965, **Hakan Plastik** has achieved so many breakthroughs as the first company that produced the silent pipe in Turkey and has reflected the importance that it attaches to development and change to its products and services as well.

GF Hakan Plastik has two production plants in Çerkezköy and Şanlıurfa. With the acquisition by GF, global GF product and process standards applicable worldwide have started to be applied. **GF Hakan Plastik** operates in the fields of Building Technology (BT) and Utility (UT) in plastic piping sector. Exporting its products to over 70 countries, the company has 7 sales areas in Turkey.

GF Hakan Plastik Training and Technology Center provides all its business partners with services with the aim of increasing the knowledge and awareness in the sector through both technical and practical trainings. Reaching out to a wider audience at the center such as the professionals serving the sector, university students and installers and providing diverse training and seminar programs for each stakeholder; the products of **GF Hakan Plastik** are promoted and information is provided about the accurate method of application of the products.



+ Our Market Segments

Based on its experience and high production technology in the sector, GF Hakan Plastik supports its clients in each phase of their projects.

- Building Technology Projects
- Industrial Buildings
- Utility Projects
- Irrigation Projects

+ Our Presence in the World

With our presence as a global brand, we choose to be closer to our clients.

GF Hakan Plastik exports its products to over 70 countries. As Georg Fischer Piping Systems, we provide our clients in over 100 countries with fast response and services.

We act in compliance with the local standards in our over 30 production plants in Europe, Asia and the USA. We ensure fast deliveries with our modern logistics organization deployed at our local distribution hubs.

+ Benefits of Plastics

Plastics are polymers created by the chemical conversion of natural products or synthesized from organic materials. The primary components that make up the building blocks of plastics are long chains of carbon (C) and hydrogen (H) known as monomers.

The raw materials used for the production of plastics are natural compounds such as cellulose, coal, oil and natural gas. In the plastics industry, around 6 % of the petroleum products that come out from refineries is used.

Plastics fall into three main categories on the basis of their internal structure and the resulting mechanical characteristics: thermoplastics, thermosetting plastics and elastomers.

+ Complete Solution Concept

Our wide range of products and services represent our complete solution concept.

With our products intended for diverse sectors, we offer individual and comprehensive system solutions. Focusing on the needs of projects, we optimize the processes and applications integrated into the entire system.

We provide state-of-the-art technology by setting the standards in the market at all times. We always stand by our business partners through our experience in the piping systems and reliable service network.

As an industrial company that stands out with innovative and successful operations ever since our incorporation, we act as a solution point to meet all your needs based on our technical knowledge, specialization and reliability.

Thermoplastics in turn can be split into two main categories as partially-regulated (semi-crystalline) and irregular (amorphous) molecular structures.

- Semicrystalline thermoplastics, which have a partially ordered molecular structure: this category includes the polyolefins (polypropylene, polyethylene, polybutylene) and fluoropolymers (PVDF, PTFE, etc.)
- Amorphous thermoplastics, which have no crystalline regions and no packed molecular structure: this category includes the vinyl chlorides (PVC-U, PVC-C, etc.) and styrenes (ABS, polystyrene, etc.)

Semicrystalline materials are more suitable for hot welding, while amorphous thermoplastics are ideal for cementing or cold welding (solvent cementing).

+ Advantages of Plastics

Thermoplastics obviously demonstrate different characteristics than those of the metals traditionally used for piping.

Metal Systems

High density

- * Crane needed for transport
- * Widely spaced fixings
- * High anchoring forces, fixing required

Thermal conductivity

- * Insulation is always needed to limit heat loss
- Formation of condensation and resulting corrosion *

Corrosion Behaviors

- Galvanic corrosion may occur
- Internal diameter is reduced due to corrosion
Reduction in internal diameter leads to pressure losses

Chemical resistance

- * Low resistance to acids, requiring use of costly alloys
- * Damage from incrustation

Plastic Systems

Low density

- * Can be carried by hand up to d110
- * Closely spaced fixings
- * Limited anchoring forces, simple and economic

Low thermal conductivity

- * Limited heat loss
- Low levels of condensation and resistance to corrosion

High Corrosion Resistance

- No risk of galvanic corrosion risk
- No corrosion and reduction of internal diameter
No pressure losses due to lack of reduction of internal diameter

High chemical resistance

- * In combination with correct jointing methods, at least 25 years of useful life can be warranted
- * No incrustation

+ Service Life Analysis of Plastics

It is the total of all greenhouse gases emitted to the atmosphere during the entire lifetime including the processes for extracting a product having carbon footprint from under the ground, refining, producing, using and disposing of that product.

The following graphics indicate the assessment of the lifetime of thermoplastic piping systems in terms of the quality of their environmental performance and application of them in building technology, industry and water and gas distribution. In the analysis, the impacts of one meter long pipe was compared with the main competitor materials (DN25, DN80, DN150 and DN400) for each of the commonly used plastics. GF supplied this analysis from an independent, Swiss-based organization specialized in environmental performance analyzes, and is based on Ecoinvent, leading lifecycle inventory database in the world.

According to the main results of the study, plastic piping systems demonstrate better performance than metal systems. This finding has been confirmed by other studies conducted in this field.

The main reason for high performance of thermoplastics is that they are lightweight. This ensures key benefits during transport and installation. Fully-plastic solutions are lighter than other piping systems of conventional materials, and this creates significant impacts on carbon footprint.

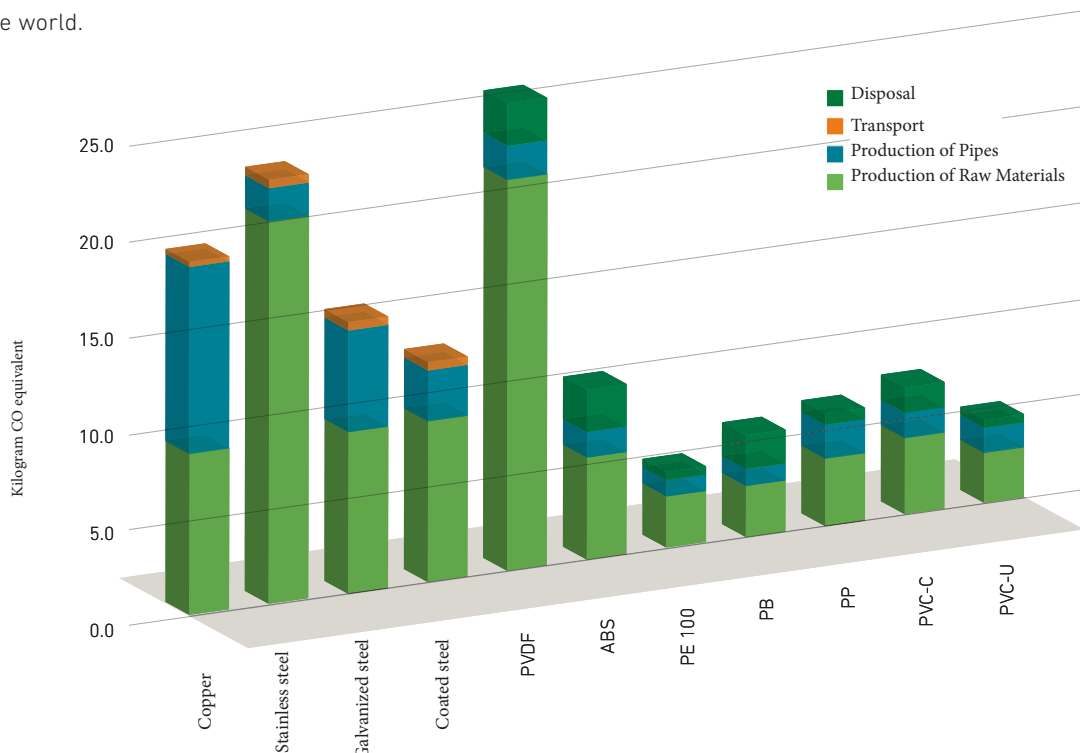

Quality Certificates

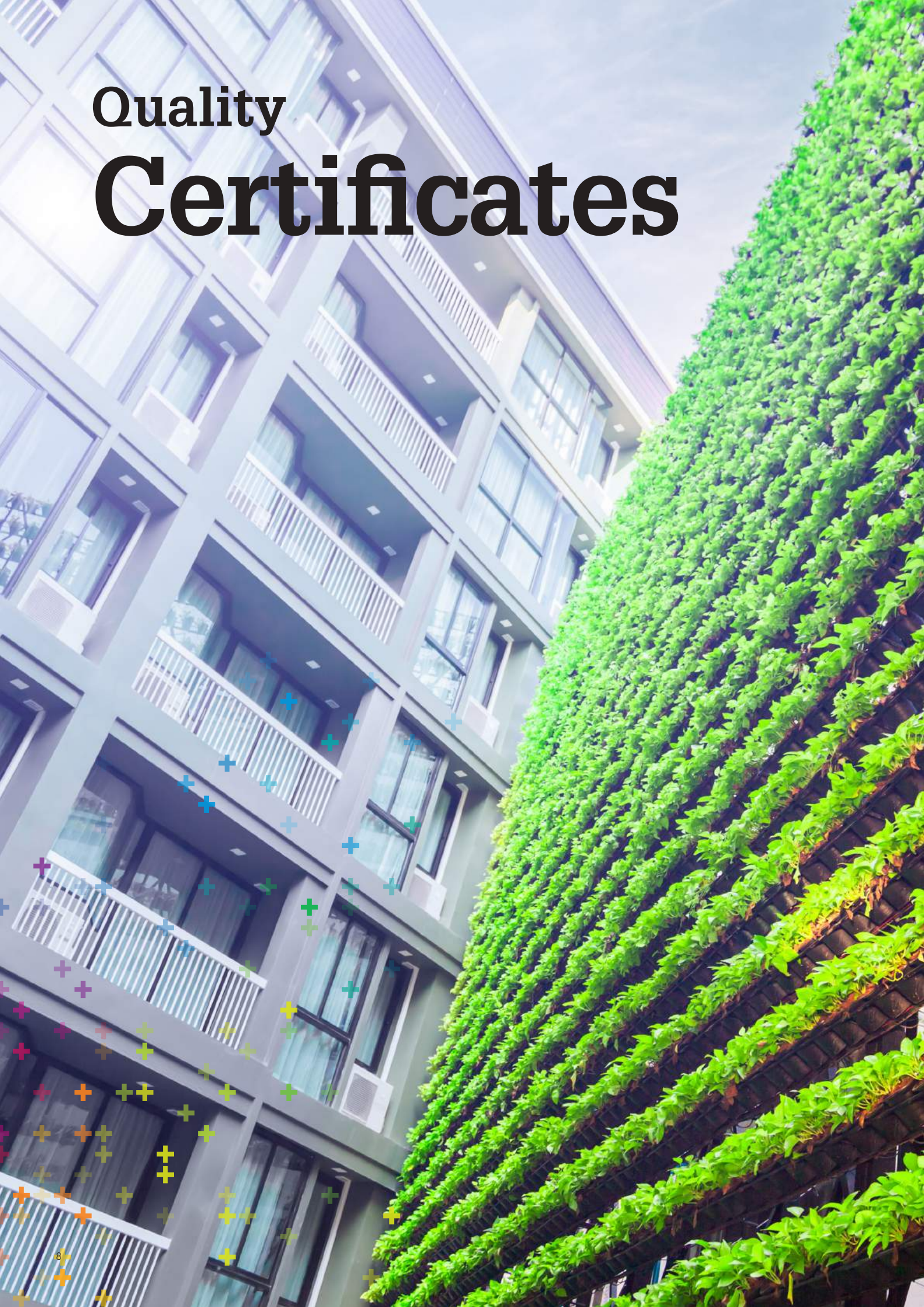

Manufacturing its products in accordance with the European standards and Turkish standards equivalent to the European standards, our Company is a leading and dynamic organization in terms of continuous improvement and customer satisfaction.

Some of the product quality certificates of our Company are as follows:

DVGW (Germany) - SKZ (Germany) - Hygiene Institute (Germany) - Fraunhofer (Germany) - Nordic Polymark (Sweden) - AENOR (Spain) - UkrSepro (Ukraine) - GOST (Russia) - SABS (South Africa) - TSE (Turkey)

Presenting its product standards in a way that offers the quality and continuity required for customers, GF Hakan Plastik exports its products to over 70 countries based on these certificates.

In addition to product quality, the process and system quality of GF Hakan Plastik is certified by BVQI through ISO 9001:2015 certificate and the company maintains its efforts on certification. Our Company that places top priority on process and system quality also has ISO 14001:2015 and OHSAS 18001:2007 certificates. Our both production plants in Çerkezköy and Şanlıurfa have TS EN ISO/IEC 17025:2012 laboratory accreditation certificates awarded by TÜRKAK organization.

Certificates

| | | | |
|---|--|--|--|
|  TURKEY- TSE |  SCANDINAVIAN COUNTRIES SWEDCERT |  TURKEY TÜRKAK |  RUSSIA-BELARUS UKRAINE GOST-r |
|  SPAIN AFITI LICOF |  GERMANY DIN CERTCO |  SWITZERLAND SGS |  RUSSIA-BELARUS KAZAKHSTAN-KYRGYZSTAN ARMENIA |
|  UKRAINE UKR - SEPRO |  NETHERLANDS KIWA |  BULGARIA BULGARKONTROLA |  UK WRAS |
|  UKRAINE HYGIENE |  SCANDINAVIAN COUNTRIES SWEDCERT KIWA |  HUNGARY HUNGARY - EMI |  RUSSIA HYGIENE |
|  BUREAU VERITAS |  SOUTH AFRICA SABS |  GERMANY- RUSSIA HYGIENE INSTITUT |  GERMANY HOCH |
|  SOUTH AFRICA SANAS |  UK LLOYD'S REGISTER |  TURKEY EUROGAP |  BULGARIA NJN |
|  TURKEY YILDIZ TECHNICAL UNIVERSITY REPORT |  MALAYSIA IKRAM QA |  GERMANY DVGW |  GERMANY DIBT |
|  UNITED STATES OF AMERICA NSF |  GERMANY FRAUNHOFER INSTITUTE |  SPAIN AENOR |  STN TC |

Silenta Premium

Sound-Insulated Piping Systems

Silenta Premium is a sound-insulating 3-layered sewer pipe system made of PP material which is specially formulated and reinforced for non-pressurized domestic drainage in accordance with System Standards of EN 1451, DIN 4109 and DIN 4102.

- Silenta Premium Sound-Insulated Pipe Systems providing a complete solution with advanced level durability, impact resistance, low sound level and easy installation features have considerably wide product range
- It reached 13 dB(A) sound intensity level at the flow rate of 4 l/s in the tests conducted by the German Fraunhofer Institute according to EN 14366
- It can be used in the underground and aboveground drainage systems even in the areas having high traffic load
- Provides excellent sound insulation, creates ideal conditions for buildings and contributes to an increase in the property value along with the quality of life. Reduces the vibrations and unfamiliar sounds coming from the plumbing system
- It is suitable for hot/cold water and acidic liquid transfers.
- No corrosion, durable
- Alternative to cast iron pipes
- Does not contain halogen and emit lethal and poisonous gases
- 100% recyclable and environmentally friendly

+ Fields of Application

- Office buildings, conference halls etc
- Schools, libraries, hospitals, hotels, houses
- All underground drainage systems between the building and the main pipeline
- Sustainable / green buildings
- Industrial areas (short and long-term use)





+ STRUCTURE

1 Inner Layer

It provides a perfect flow performance with its structure. The superior chemical resistance prevents corrosion and abrasion. It is resistant to high water temperatures.

2

Middle Layer

With its high molecular structure and special composite formula, the sound waves are absorbed and prevented.

3

Outer Layer

It is resistant to high temperatures and impacts.

4

Special Gasket System

It guarantees water tightness with its special gasket structure providing ease of montage. The geometrical properties of the gasket groove ensure fast and easy installation.

+ Technical Properties

| | |
|-------------------------------|--|
| Pipe Structure | 3-Layered (Special PP-Mineral reinforced composite) |
| Diameters [mm] | d58, d78, d90, d110, d135, d160, d200 |
| Pipe length [mm] | 150, 250, 500, 1000, 2000, 3000 |
| Sound transmission | 13 dB(A) at 4 l/s (EN 14366) |
| Fire class | B2 (DIN 4102) |
| Joining method | Joining with Rubber Gasket and Socket (Push-Fit) |
| Clamping | With GF Hakan Silent pipe clamps |
| Color | Light Grey (Halogen-free and Cadmium-free) |
| Installation | Very easy to install thanks to its weight lower than cast-iron pipes |
| Thermal expansion coefficient | 0.04 mm/m°K |
| Tensile strength | 13 N/mm ² |
| Chemical resistance | Resistant to organic and inorganic chemical environments for pH values between 2 and 12 |
| Installation temperature | Minimum: -10°C Maximum: 60°C |
| Operating temperature | Minimum: -10°C Maximum: 97°C |
| Application class | B/D (building / drainage) |
| Ring Stiffness | ISO/DIN 9969, The ring stiffness is at least 4.0 kN / m ² over the entire range of – dimensions: 58 mm – 200 mm |
| Impact strength | Complies with EN 1451 |
| Approvals and Certificates | Germany: DIBt, Fraunhofer, Hoch, Ukraine: Sepro, Russia: Gost, Malaysia: Ikram, Turkey: TSE |

Superior Sound-Proof Performance

Sound-insulated soil and waste water pipe system **Silenta Premium** guarantees quality, peace of mind and living comfort.

Acoustic performance of Silenta Premium was accredited by the famous German Fraunhofer Institute, in compliance with DIN 4109 and EN 14366.

Noise measurement tests were carried out at Fraunhofer Physical Constructions Institute in Stuttgart, the most accredited European laboratory on noise studies on buildings. The acoustic performance tests were conducted in compliance with the standard DIN EN 14366.

The emitted noise level at **4 l/s** flow rate, with special GF Hakan Silent clamps, is only **13 dB(A)** according to **DIN EN 14366**.

SILENTA PREMIUM ACOUSTIC PERFORMANCE dB(A)

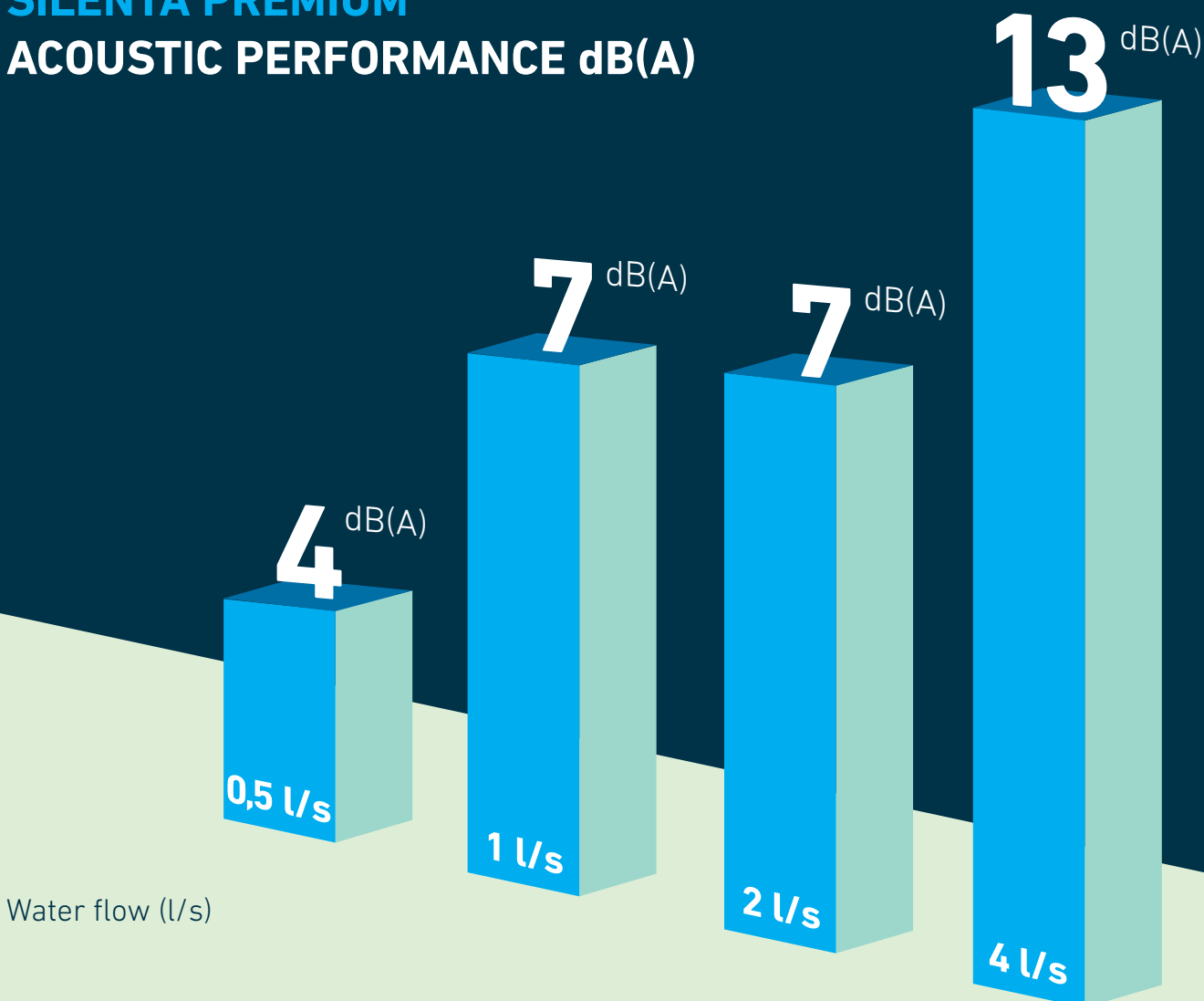

Silenta Premium

Silenta Premium Pipe with Socket



| Dia. (mm) | Leng. (mm) | Thick. (mm) | Code | Packing Type | Pc |
|-----------|------------|-------------|---------------|--------------|----|
| 58 | 150 | 4,0 | 4401005800121 | Cartonbox | 30 |
| 58 | 250 | 4,0 | 4401005800221 | Cartonbox | 25 |
| 58 | 500 | 4,0 | 4401005800321 | Cartonbox | 30 |
| 58 | 1000 | 4,0 | 4401005800421 | Bundle | 8 |
| 58 | 2000 | 4,0 | 4401005800521 | Bundle | 8 |
| 58 | 3000 | 4,0 | 4401005800621 | Bundle | 8 |
| 78 | 150 | 4,5 | 4401007801021 | Cartonbox | 40 |
| 78 | 250 | 4,5 | 4401007801121 | Cartonbox | 12 |
| 78 | 500 | 4,5 | 4401007801221 | Cartonbox | 16 |
| 78 | 1000 | 4,5 | 4401007801321 | Bundle | 6 |
| 78 | 2000 | 4,5 | 4401007801421 | Bundle | 6 |
| 78 | 3000 | 4,5 | 4401007801521 | Bundle | 6 |
| 90 | 150 | 4,5 | 4401009002021 | Cartonbox | 36 |
| 90 | 250 | 4,5 | 4401009002121 | Cartonbox | 24 |
| 90 | 500 | 4,5 | 4401009002221 | Cartonbox | 12 |
| 90 | 1000 | 4,5 | 4401009002321 | Bundle | 6 |
| 90 | 2000 | 4,5 | 4401009002421 | Bundle | 6 |
| 90 | 3000 | 4,5 | 4401009003321 | Bundle | 6 |
| 110 | 150 | 5,3 | 4401011003021 | Cartonbox | 9 |
| 110 | 250 | 5,3 | 4401011003121 | Cartonbox | 12 |
| 110 | 500 | 5,3 | 4401011003221 | Cartonbox | 8 |
| 110 | 1000 | 5,3 | 4401011003321 | Bundle | 4 |
| 110 | 2000 | 5,3 | 4401011003421 | Bundle | 4 |
| 110 | 3000 | 5,3 | 4401011003521 | Bundle | 4 |
| 135 | 150 | 5,3 | 4401013504021 | Cartonbox | 12 |
| 135 | 250 | 5,3 | 4401013504121 | Cartonbox | 8 |
| 135 | 500 | 5,3 | 4401013504221 | Cartonbox | 5 |
| 135 | 1000 | 5,3 | 4401013504321 | Bundle | 4 |
| 135 | 2000 | 5,3 | 4401013504421 | Bundle | 4 |
| 135 | 3000 | 5,3 | 4401013504521 | Bundle | 4 |
| 160 | 150 | 5,3 | 4401016005021 | Cartonbox | 10 |
| 160 | 250 | 5,3 | 4401016005121 | Cartonbox | 6 |
| 160 | 500 | 5,3 | 4401016005221 | Cartonbox | 4 |
| 160 | 1000 | 5,3 | 4401016005321 | Length | 1 |
| 160 | 2000 | 5,3 | 4401016005421 | Length | 1 |
| 160 | 3000 | 5,3 | 4401016005521 | Length | 1 |
| 200 | 500 | 6,2 | 4401020006021 | Cartonbox | 5 |
| 200 | 1000 | 6,2 | 4401020006121 | Length | 1 |
| 200 | 2000 | 6,2 | 4401020006221 | Length | 1 |
| 200 | 3000 | 6,2 | 4401020006321 | Length | 1 |

Silenta Premium Pipe without Socket



| Dia. (mm) | Leng. (mm) | Thick. (mm) | Code | Packing Type | Pc |
|-----------|------------|-------------|---------------|--------------|----|
| 58 | 3000 | 4,0 | 4401005810621 | Bundle | 8 |
| 58 | 5000 | 4,0 | 4401005810821 | Bundle | 8 |
| 78 | 3000 | 4,5 | 4401007811521 | Bundle | 6 |
| 78 | 5000 | 4,5 | 4401007811721 | Bundle | 6 |
| 90 | 1000 | 4,5 | 4401009003621 | Bundle | 10 |
| 90 | 3000 | 4,5 | 4401009002521 | Bundle | 6 |
| 110 | 3000 | 5,3 | 4401011013521 | Bundle | 4 |
| 110 | 5000 | 5,3 | 4401011013721 | Bundle | 4 |
| 135 | 3000 | 5,3 | 4401013514521 | Bundle | 4 |
| 135 | 5000 | 5,3 | 4401013514721 | Bundle | 4 |
| 160 | 3000 | 5,3 | 4401016015521 | Length | 1 |
| 160 | 5000 | 5,3 | 4401016015721 | Length | 1 |
| 200 | 500 | 6,2 | 4401020016021 | Cartonbox | 4 |
| 200 | 1000 | 6,2 | 4401020016121 | Length | 1 |
| 200 | 2000 | 6,2 | 4401020016221 | Length | 1 |
| 200 | 3000 | 6,2 | 4401020016321 | Length | 1 |



Silenta Premium Elbow 15°

| Dia. (mm) | Code | Packing Type | Pc |
|-----------|---------------|--------------|-----|
| 58 | 4501105800321 | Cartonbox | 120 |
| 78 | 4501107800121 | Cartonbox | 70 |
| 90 | 4501109000121 | Cartonbox | 39 |
| 110 | 4501111000521 | Cartonbox | 20 |
| 135 | 4501113500821 | Cartonbox | 12 |
| 160 | 4501116001021 | Cartonbox | 8 |



Silenta Premium Elbow 30°

| Dia. (mm) | Code | Packing Type | Pc |
|-----------|---------------|--------------|-----|
| 58 | 4501105800421 | Cartonbox | 120 |
| 78 | 4501107800221 | Cartonbox | 70 |
| 90 | 4501109000221 | Cartonbox | 39 |
| 110 | 4501111000621 | Cartonbox | 20 |
| 135 | 4501113500921 | Cartonbox | 12 |
| 160 | 4501116001121 | Cartonbox | 8 |



Silenta Premium Elbow 45°

| Dia. (mm) | Code | Packing Type | Pc |
|-----------|---------------|--------------|----|
| 58 | 4501105800121 | Cartonbox | 50 |
| 78 | 4501107800321 | Cartonbox | 60 |
| 90 | 4501109000321 | Cartonbox | 32 |
| 110 | 4501111000721 | Cartonbox | 20 |
| 135 | 4501113501021 | Cartonbox | 5 |
| 160 | 4501116001221 | Cartonbox | 8 |
| 200 | 4501120001421 | Cartonbox | 4 |



Silenta Premium Elbow 67,5°

| Dia. (mm) | Code | Packing Type | Pc |
|-----------|---------------|--------------|-----|
| 58 | 4501105800521 | Cartonbox | 100 |
| 78 | 4501107800521 | Cartonbox | 50 |
| 90 | 4501109000521 | Cartonbox | 32 |
| 110 | 4501111000821 | Cartonbox | 16 |



Silenta Premium Elbow 87,5°

| Dia. (mm) | Code | Packing Type | Pc |
|-----------|---------------|--------------|----|
| 58 | 4501105800221 | Cartonbox | 40 |
| 78 | 4501107800421 | Cartonbox | 20 |
| 90 | 4501109000421 | Cartonbox | 32 |
| 110 | 4501111000921 | Cartonbox | 16 |
| 135 | 4501113501121 | Cartonbox | 12 |
| 160 | 4501116001321 | Cartonbox | 8 |
| 200 | 4501120001521 | Cartonbox | 3 |

Silenta Premium



Silenta Premium Long Elbow 45°

| Dia. (mm) | Code | Packing | |
|--------------|----------------------|-----------|----|
| | | Type | Pc |
| 110 | 4501111001321 | Cartonbox | 8 |



Silenta Premium Siphon Elbow 87,5°

| Dia. (mm) | Code | Packing | |
|--------------|----------------------|-----------|-----|
| | | Type | Pc |
| 58-40 | 4501105830621 | Cartonbox | 140 |



Silenta Premium Clean Out Elbow 87,5°

| Dia. (mm) | Code | Packing | |
|--------------|----------------------|-----------|----|
| | | Type | Pc |
| 110 | 4501311001121 | Cartonbox | 15 |



Silenta Premium Branch 45°

| Dia. (mm) | Code | Packing | |
|--------------|----------------------|-----------|----|
| | | Type | Pc |
| 58-58 | 4501205800121 | Cartonbox | 20 |
| 78-58 | 4501207800221 | Cartonbox | 30 |
| 78-78 | 4501207800321 | Cartonbox | 20 |
| 90-58 | 4501209000121 | Cartonbox | 8 |
| 90-90 | 4501209000321 | Cartonbox | 14 |
| 110-58 | 4501211000421 | Cartonbox | 18 |
| 110-78 | 4501211000521 | Cartonbox | 14 |
| 110-110 | 4501211000621 | Cartonbox | 10 |
| 135-78 | 4501213500721 | Cartonbox | 10 |
| 135-110 | 4501213500821 | Cartonbox | 6 |
| 135-135 | 4501213500921 | Cartonbox | 5 |
| 160-110 | 4501216001021 | Cartonbox | 5 |
| 160-135 | 4501216001121 | Cartonbox | 4 |
| 160-160 | 4501216001221 | Cartonbox | 3 |
| 200-110 | 4501220001421 | Cartonbox | 2 |
| 200-135 | 4501220001521 | Cartonbox | 2 |
| 200-160 | 4501220001621 | Cartonbox | 1 |
| 200-200 | 4501220001721 | Cartonbox | 3 |



Silenta Premium Branch 67,5°

| Dia. (mm) | Code | Packing | |
|--------------|----------------------|-----------|----|
| | | Type | Pc |
| 58-58 | 4501207805021 | Cartonbox | 18 |
| 78-58 | 4501207805021 | Cartonbox | 30 |
| 78-78 | 4501207805521 | Cartonbox | 20 |
| 110-58 | 4501211001021 | Cartonbox | 18 |
| 110-78 | 4501211001121 | Cartonbox | 14 |
| 110-110 | 4501211000721 | Cartonbox | 12 |



Silenta Premium Branch 87,5°

| Dia. (mm) | Code | Packing | |
|--------------|----------------------|-----------|----|
| | | Type | Pc |
| 58-58 | 4501205806021 | Cartonbox | 15 |
| 78-58 | 4501207806121 | Cartonbox | 8 |
| 78-78 | 4501207806221 | Cartonbox | 7 |
| 90-58 | 4501209006121 | Cartonbox | 18 |
| 90-78 | 4501209006221 | Cartonbox | 15 |
| 90-90 | 4501209006321 | Cartonbox | 12 |
| 110-58 | 4501211006321 | Cartonbox | 18 |
| 110-78 | 4501211006421 | Cartonbox | 15 |
| 110-90 | 4501211006621 | Cartonbox | 15 |
| 110-110 | 4501211006521 | Cartonbox | 12 |
| 135-110 | 4501213506621 | Cartonbox | 8 |
| 135-135 | 4501213506721 | Cartonbox | 6 |
| 160-110 | 4501216006621 | Cartonbox | 5 |
| 160-160 | 4501216006921 | Cartonbox | 4 |



Silenta Premium Radius Branch 87,5° (Swept)

| Dia. (mm) | Code | Packing | |
|--------------|----------------------|-----------|----|
| | | Type | Pc |
| 90-90 | 4501209030621 | Cartonbox | 16 |
| 110-90 | 4501211031321 | Cartonbox | 8 |
| 110-110 | 4501211031221 | Cartonbox | 8 |



Silenta Premium Double Branch 45°

| Dia. (mm) | Code | Packing | |
|--------------|----------------------|-----------|----|
| | | Type | Pc |
| 110-110 | 4501211004121 | Cartonbox | 8 |
| 135-110 | 4501213504221 | Cartonbox | 4 |
| 160-110 | 4501216004321 | Cartonbox | 3 |



Silenta Premium Double Branch 87,5°

| Dia. (mm) | Code | Packing | |
|--------------|----------------------|-----------|----|
| | | Type | Pc |
| 90-90 | 4501209007021 | Cartonbox | 8 |
| 110-110 | 4501211007021 | Cartonbox | 10 |



Silenta Premium Clean Out Tee

| Dia. (mm) | Code | Packing | |
|--------------|----------------------|-----------|----|
| | | Type | Pc |
| 110-110 | 4501311002121 | Cartonbox | 10 |
| 160-78 | 4501316001321 | Cartonbox | 5 |
| 160-110 | 4501316002321 | Cartonbox | 5 |

Silenta Premium



Silenta Premium Corner Double Branch 87,5°

| Dia. (mm) | Code | Packing | |
|--------------|----------------------|-----------|----|
| | | Type | Pc |
| 110-110 | 4501211007121 | Cartonbox | 10 |



Silenta Premium Corner Radius Double Branch 87,5° (Swept)

| Dia. (mm) | Code | Packing | |
|--------------|----------------------|-----------|----|
| | | Type | Pc |
| 90-90 | 4501209030721 | Cartonbox | 12 |

Silenta Premium Sliding Socket



| Dia. (mm) | Code | Packing | |
|--------------|----------------------|-----------|----|
| | | Type | Pc |
| 58 | 4501505804021 | Cartonbox | 12 |
| 78 | 4501507804121 | Cartonbox | 16 |
| 110 | 4501511004221 | Cartonbox | 15 |
| 135 | 4501513504521 | Cartonbox | 10 |
| 160 | 4501516004321 | Cartonbox | 6 |
| 200 | 4501520004421 | Cartonbox | 4 |

Silenta Premium Socket Plug



| Dia. (mm) | Code | Packing | |
|--------------|----------------------|-----------|----|
| | | Type | Pc |
| 58 | 4501905800121 | Cartonbox | 25 |
| 78 | 4501907800221 | Cartonbox | 50 |
| 90 | 4501909000321 | Cartonbox | 50 |
| 110 | 4501911000321 | Cartonbox | 20 |
| 135 | 4501913500421 | Cartonbox | 40 |
| 160 | 4501916000521 | Cartonbox | 12 |

Silenta Premium Adaptor



| Dia. (mm) | Code | Packing | |
|--------------|----------------------|-----------|-----|
| | | Type | Pc |
| 58-50 | 4501905801021 | Cartonbox | 150 |
| 78-75 | 4501907801021 | Cartonbox | 75 |
| 135-125 | 4501913501021 | Cartonbox | 22 |

Silenta Premium Reducer



| Dia. (mm) | Code | Packing | |
|--------------|----------------------|-----------|-----|
| | | Type | Pc |
| 58-40 | 4501405800221 | Cartonbox | 175 |
| 58-50 | 4501405800121 | Cartonbox | 60 |
| 78-50 | 4501407802421 | Cartonbox | 50 |
| 78-58 | 4501407800221 | Cartonbox | 40 |
| 78-75 | 4501407800321 | Cartonbox | 25 |
| 90-58 | 4501409000121 | Cartonbox | 80 |
| 90-78 | 4501409000221 | Cartonbox | 32 |
| 110-58 | 4501411000421 | Cartonbox | 25 |
| 110-78 | 4501411000521 | Cartonbox | 50 |
| 110-90 | 4501411000621 | Cartonbox | 40 |
| 135-110 | 4501413500621 | Cartonbox | 10 |
| 160-110 | 4501416000821 | Cartonbox | 20 |
| 160-135 | 4501416000921 | Cartonbox | 12 |
| 200-160 | 4501420001121 | Cartonbox | 10 |

Silenta Premium Repair Pipe (Long Socket)



| Dia. (mm) | Code | Packing | |
|--------------|----------------------|-----------|----|
| | | Type | Pc |
| 110 | 4501911001221 | Cartonbox | 15 |

Silenta Premium Clean Out (Circular)



| Dia. (mm) | Code | Packing | |
|--------------|----------------------|-----------|----|
| | | Type | Pc |
| 58 | 4501305800421 | Cartonbox | 50 |
| 78 | 4501307800521 | Cartonbox | 28 |
| 90 | 4501309000121 | Cartonbox | 12 |

Silenta Premium Socket with Central Register



| Dia. (mm) | Code | Packing | |
|--------------|----------------------|-----------|----|
| | | Type | Pc |
| 58 | 4501505803021 | Cartonbox | 25 |
| 78 | 4501507803121 | Cartonbox | 15 |
| 90 | 4501509003121 | Cartonbox | 45 |
| 110 | 4501511003221 | Cartonbox | 36 |
| 135 | 4501513503321 | Cartonbox | 20 |
| 160 | 4501516003421 | Cartonbox | 6 |
| 200 | 4501520003521 | Cartonbox | 4 |

Silenta Premium Clean Out (Rectangular)



| Dia. (mm) | Code | Packing | |
|--------------|----------------------|-----------|----|
| | | Type | Pc |
| 110 | 4501311000121 | Cartonbox | 10 |
| 135 | 4501313500221 | Cartonbox | 6 |
| 160 | 4501316000321 | Cartonbox | 2 |

Silenta Premium

* Silenta Premium S Siphon 45°



| Dia. (mm) | Code | Packing | |
|--------------|---------------|-----------|----|
| | | Type | Pc |
| 110 | 4501611000121 | Cartonbox | 8 |

* Silenta Premium S Siphon 87,5°



| Dia. (mm) | Code | Packing | |
|--------------|---------------|-----------|----|
| | | Type | Pc |
| 110 | 4501611000221 | Cartonbox | 7 |

Silenta Premium Floor Trap



| Dia. (mm) | Code | Packing | |
|--------------|---------------|-----------|----|
| | | Type | Pc |
| 110-78-58-58 | 4501911030322 | Cartonbox | 12 |

Silenta Premium Floor Trap - Long



| Dia. (mm) | Code | Packing | |
|--------------|---------------|-----------|----|
| | | Type | Pc |
| 110-78-58-58 | 4501911030622 | Cartonbox | 12 |

Silenta Premium P - Trap

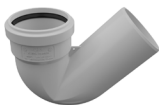

| Dia. (mm) | Code | Packing | |
|--------------|---------------|-----------|----|
| | | Type | Pc |
| 110 | 4501611000521 | Cartonbox | 15 |

Silenta Premium Collector 4x58 Out



| Dia. (mm) | Code | Packing | |
|--------------|---------------|-----------|----|
| | | Type | Pc |
| 110 | 4501911031021 | Cartonbox | 12 |

Silenta Premium Double Branch 87° (4x58 mm Outlet)



| Dia. (mm) | Code | Packing | |
|--------------|---------------|-----------|----|
| | | Type | Pc |
| 110 | 4501211014121 | Cartonbox | 2 |

Silenta Premium Double Branch 87,5° (5x58 mm Outlet)



| Dia. (mm) | Code | Packing | |
|--------------|---------------|-----------|----|
| | | Type | Pc |
| 110 | 4501211013121 | Cartonbox | 2 |

Silence Clamp Metal - Vertical Set



| Dia. (mm) | Code | Packing | |
|--------------|---------------|-----------|----|
| | | Type | Pc |
| 50 | 1300905030412 | Cartonbox | 20 |
| 58 | 1300905830412 | Cartonbox | 20 |
| 75-78 | 1300907530412 | Cartonbox | 15 |
| 110 | 1300911030412 | Cartonbox | 10 |
| 135 | 1300913530412 | Cartonbox | 10 |
| 160 | 1300916030412 | Cartonbox | 7 |
| 200 | 1300920030412 | Cartonbox | 5 |

Silence Clamp Metal - Horizontal



| Dia. (mm) | Code | Packing | |
|--------------|---------------|-----------|----|
| | | Type | Pc |
| 50 | 1300905030612 | Cartonbox | 50 |
| 58 | 1300905830612 | Cartonbox | 30 |
| 75-78 | 1300907530612 | Cartonbox | 30 |
| 110 | 1300911030612 | Cartonbox | 25 |
| 135 | 1300913530612 | Cartonbox | 25 |
| 160 | 1300916030612 | Cartonbox | 25 |
| 200 | 1300920030612 | Cartonbox | 20 |



Silenta Premium Aerator

| Dia. (mm) | Code | Packing | |
|--------------|---------------|-----------|----|
| | | Type | Pc |
| 110-110-78 | 4501911000121 | Cartonbox | 2 |

What is Sound Insulation Performance?

Sound insulation performance is the sound insulation capability of the system against the vibrations that occur between the pipes used in the waste water installation and the fluids transmitted through these pipes. With Silenta Premium, Silenta 3A and Silenta FR Piping Systems, GF Hakan Plastik offers ultimate solutions against the sounds created in the installations.

Sources of sounds in the buildings can be listed as follows:

- Flushing
- Clogging of the flowing direction
- High water speeds
- Joints
- Discharge
- Wrong planning
- Faulty design

Due to critical drainage conditions, local vibrations occur in the piping system passages. They could have adverse impacts on sound characteristics.

To minimize and eliminate these impacts, Silenta Product Ranges reduce noise in the sound-critical areas with elbows having nominal widths of DN 58-DN 200, and ensures better noise reduction in the affected areas.

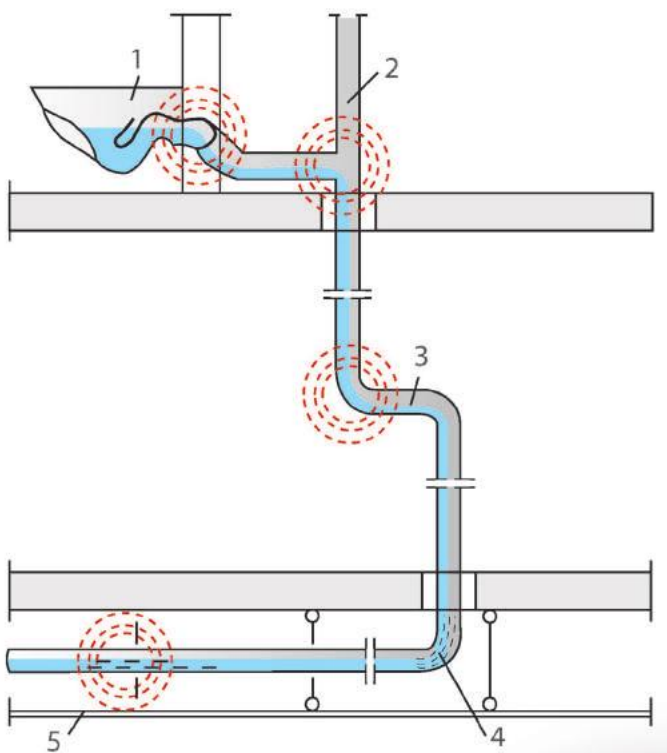

Why is Sound Protection Necessary?

Sound protection measures in a building aims to minimize the noise pollution in the rooms. Residents need to be protected against the noises emitted through air or caused by the building.

Unpleasant noises within the building as caused directly (created by the building) or indirectly (for example due to the construction engineering systems) can be easily resolved with the use of Silenta Product Range.

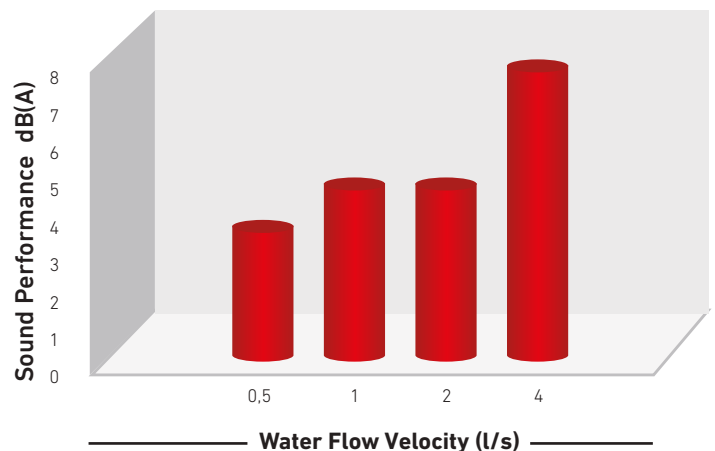

The above graphics indicate the results of the acoustic tests conducted by Fraunhofer Building Physics Institute.

- Silenta Premium 13 dB(A) at 4 l/s flow*
- Silenta 3A 16 dB(A) at 4 l/s flow*
- Silenta FR 12 dB(A) at 4 l/s flow*

Packaging, Storage and Transportation

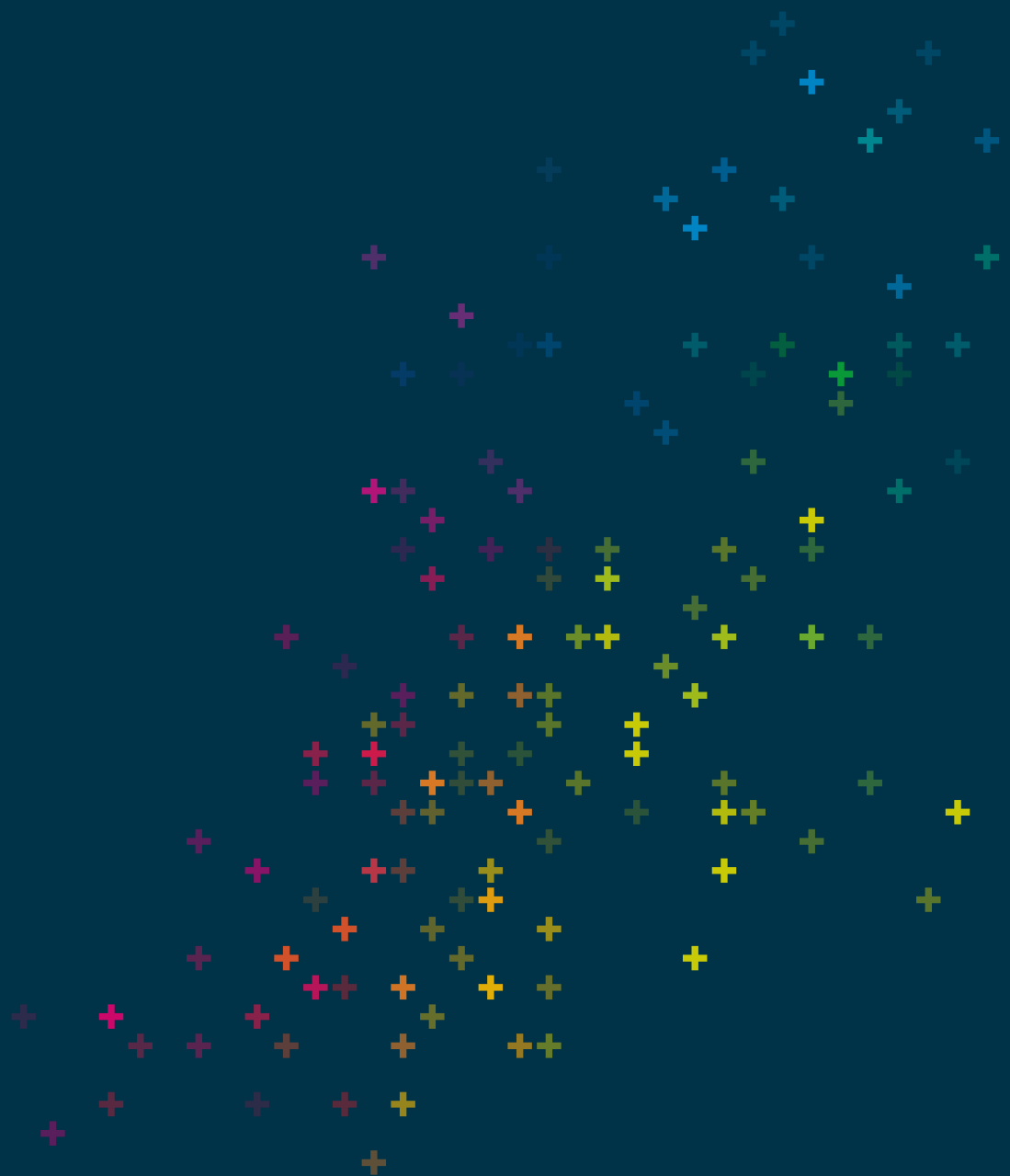

Packaging

GF Hakan Plastik pipes and fittings are packed as ready for transport in a customer-friendly way. Packing ensures safety, efficient storage and easy transport.

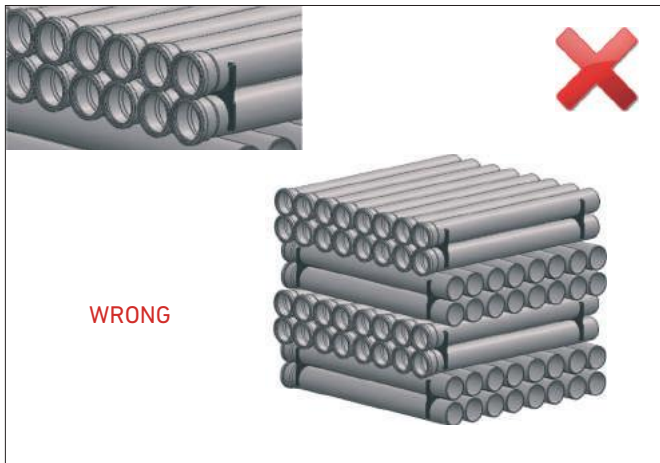
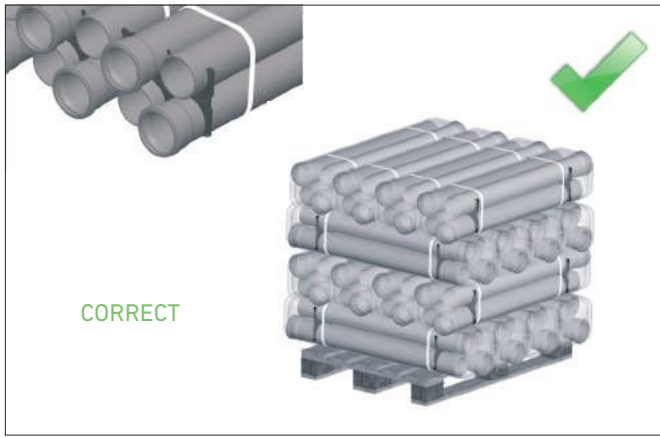

Pipes and fittings with socket are placed in a way that they will not stay on top of each other.



Pipes are packed by plastic clamps to hold them together. Stretch film is applied to protect pipes from pipes dust and stains.



Waste water pipes are shipped on wooden frames or pallets according to the demands of customers.



Short parts with the length of 150, 250 and 500 mm are packed in carton boxes like connection parts.



All product ranges are identified in the Warehouse Management System (WMS) by barcode label. Barcode system ensures management of products and prevents complexity and errors during storage and loading.

Storage



Method of storage should not cause any outflow and should not damage the pipes. As long as they are stored properly, no permanent deformations or damages will occur on the pipes and fittings. Pipes should not be stacked above 1,5 m. Pipes should be safe against sliding.

Pipes packed in the factory might be stacked on wooden frames. Appropriate materials such as pallet etc. should be used to prevent any damage on the socket parts of the pipes stored for a long time. This also makes it easier to lift the pipes by from the floor.

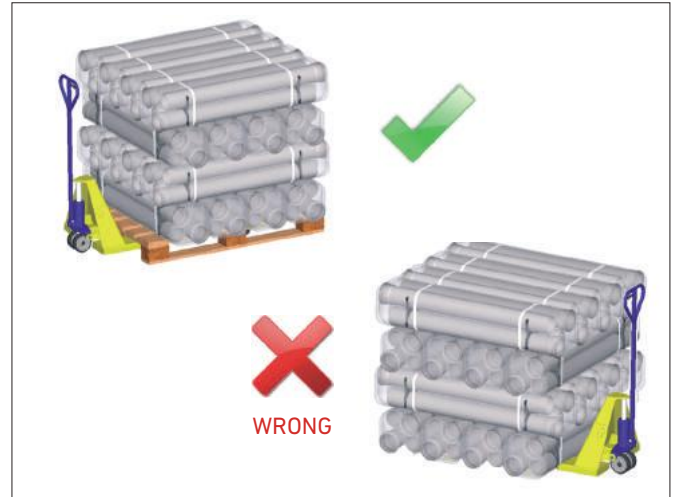

Pipes and fittings packed in carton boxes should be protected against moisture. Carton boxes should be sealed and stored in a dry area.



Products that are not resistant to UV should not be stored outdoors and should be protected against sunlight.

Transportation

Pipes should be carefully transported to prevent any damages. Avoid sudden and hard pressures on pipes and fittings that might cause freezing in cold weather conditions. Ensure that pipes are not slid and dropped on the floor. Loading and unloading and packing of pipes in a block should be carried out by means of forklifts having flat threads and extensions.

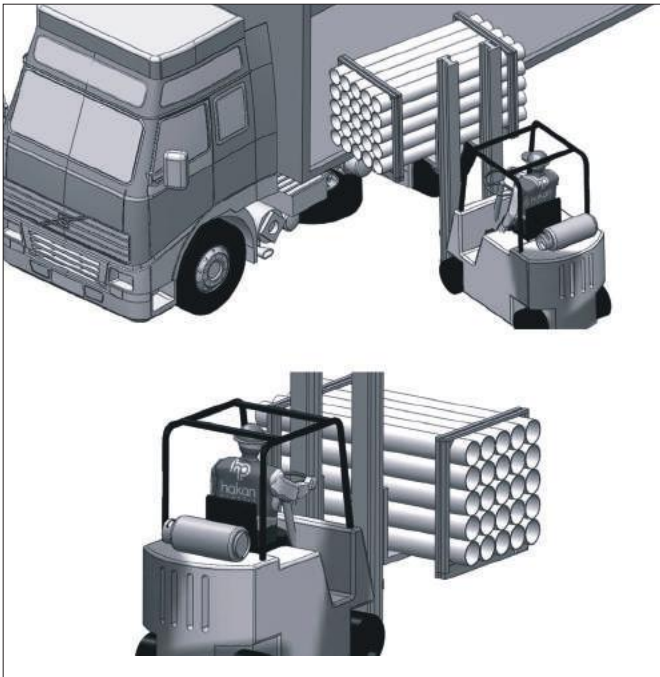

Silenta Premium Installation

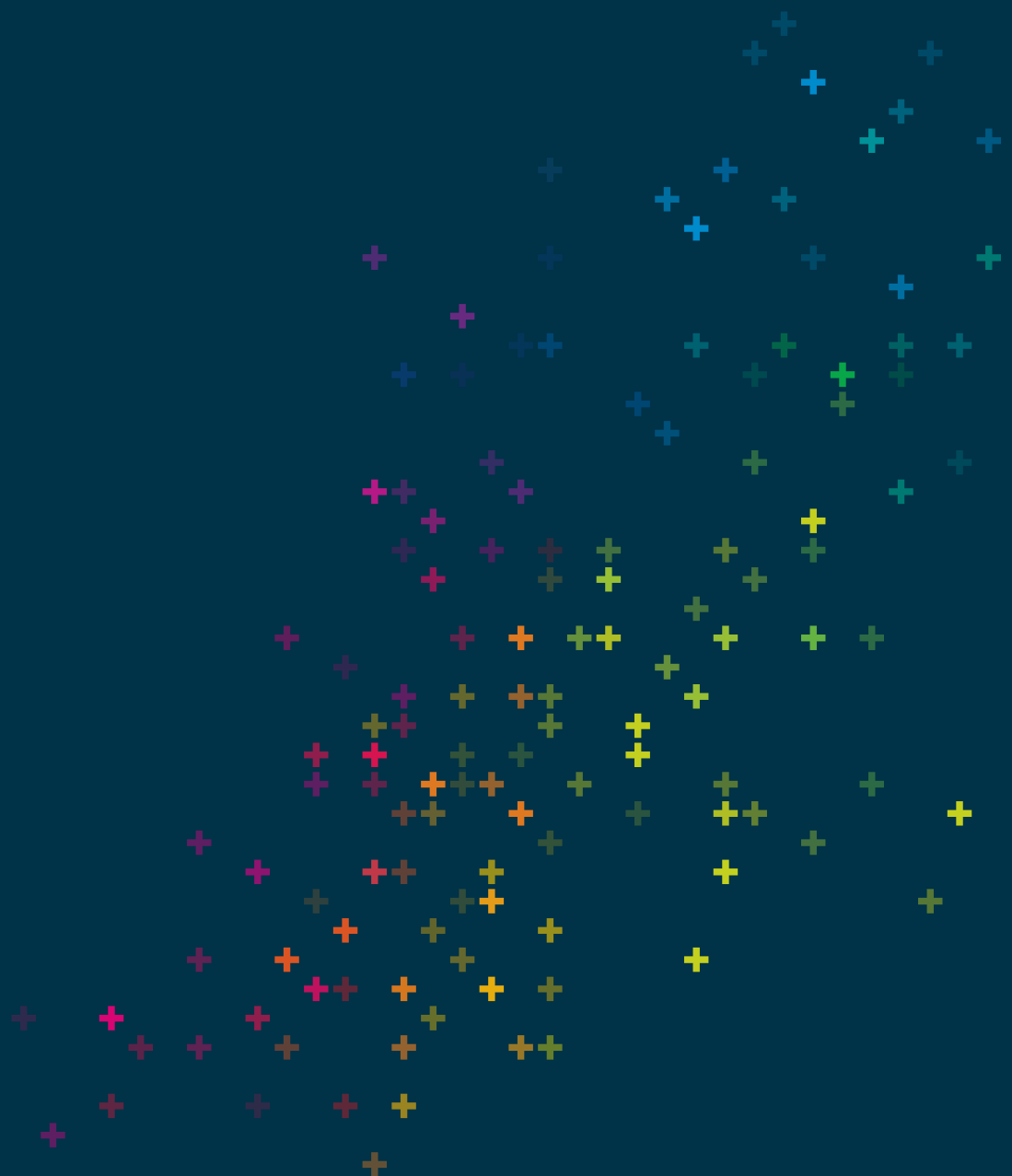

Installation

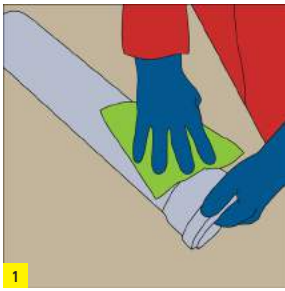

Make sure that your products are clean. If necessary, wipe the jointing points with a dry cloth.

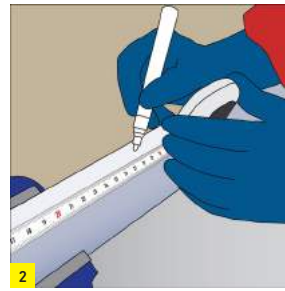

When interval measurements are required, mark the pipe with the desired measurements.



Cut in 90° angle by using a coping saw or a proper cutter.

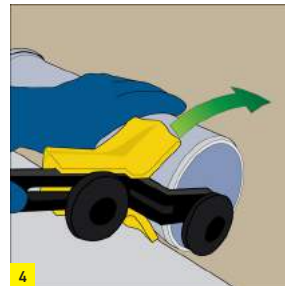

Chamfer the spigot of pipe by using a chamfering device or thick riffler.



Remove the burrs on the external edges with a knife or scraper.

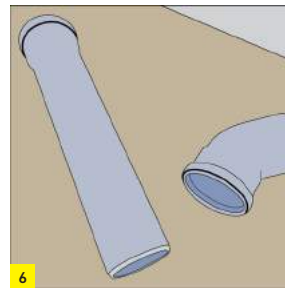

Now, your pipe is ready for installation.

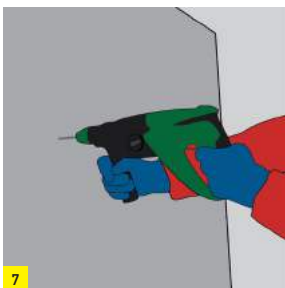

Drill the marked points with a driller and place dowels into the holes.

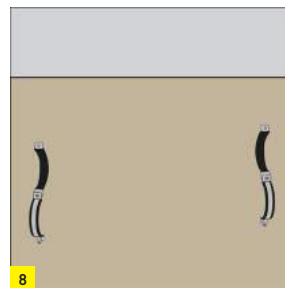

Mark the pipe clamp distances properly with 1% inclination on the wall or ceiling where they will be installed. (as flat wall)

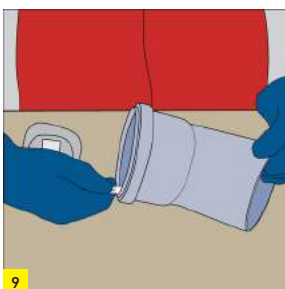

Mark the part of the pipe that will be attached to the fitting as much as the jointing distance.



Apply a lubricating liquid (silicone etc.) to the socket part of the pipe.

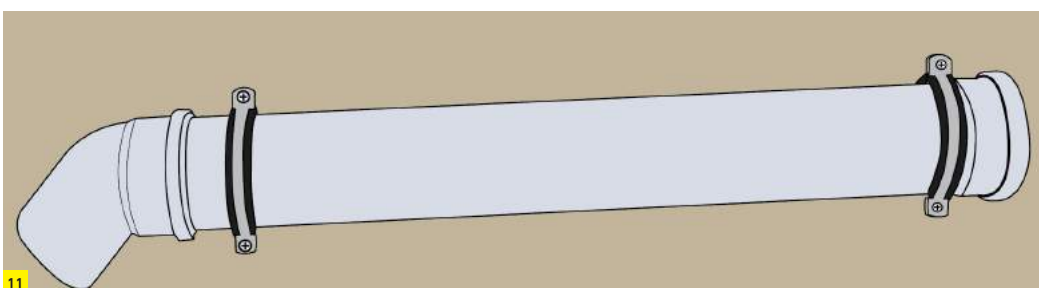

After the pipe and fittings are jointed, place them and tighten the clamps.

Installation

Rubber Ring (Push Fit) Jointing

- 1- Mouth of the pipe should be absolutely chamfered. If the mouth of the pipe was cut, it should be chamfered.
- 2- Check if the sealing gasket is accurately placed on the pipe or fitting socket groove.
- 3- All installation parts should be dry and clean. There should be no deformation, notches or similar scratches on the pipes or fittings.
- 4- Apply a proper silicone-based lubricating liquid on the spigot end of the pipe or fitting. Do not use liquid soap, grease or similar petroleum derivatives.

- 5- Parts to be jointed should be levelled.
- 6- Push the spigot end of the pipe or fitting into the socket completely. If the application is longer than 2 m, pull the spigot end 10 mm back after placing it into the socket completely, to prevent the effects of thermal expansion.
- 7- Finally, check again if the gap left for thermal expansion still exists or not.

Pipe Hanging and Clamping

Always use GF Hakan silent pipe clamp to minimize the sound caused by vibration. Maximum clamping distances of the pipes should always comply with the values provided in the following table.

- 1- While fixing the pipe with clamps, pay special attention to not cause any tension and stress on pipes.
- 2- Pipe cannot move after tightening the screws of the fixed clamps. For sliding clamps, pipe will continue to move inside the clamp even after tightening the screws.
- 3- For each line longer than 2 m, use 1 fixed clamp immediately after the muff part.
- 4- In vertical lines, always place the fixed clamp on the top point of the pipe and below the socket part.

- 5- While fitting the fixed clamp, pay attention to keep 10 mm distance left on the flat end for expansion.
- 6- Use a fixed clamp after each fitting or fitting group.
- 7- All clamps to be added to the system apart from the fixed clamps in the horizontal or vertical line should be sliding clamp that allows for thermal expansion caused by temperature changes.
- 8- Pipes and fittings should be fixed in short distances so that they do not slide and release.

Maximum distances between the clamps

| Nominal External Diameter DN [mm] | Clamp Distance | |
|--------------------------------------|---|---------------------------------------|
| | For Horizontal Pipe Directions* Dmax m (max. 15 x da) | For Vertical Pipe Directions* Dmax. m |
| 50 | 0,75 | 1,50 |
| 75 | 1,10 | 2,00 |
| 90 | 1,35 | 2,00 |
| 110 | 1,65 | 2,00 |
| 125 | 1,85 | 2,00 |
| 160 | 2,40 | 2,00 |
| 200 | 3,00 | 2,00 |
| 250 | 3,00 | 2,00 |

Installation

Silent Pipe Clamp

Silent waste water piping systems are tested by the German Fraunhofer Building Physics Institute in accordance with EN 14366 standard, and the reports about sound level are issued by this institute.

In the test equipment used in this institute, sound levels are measured at different flows and different parts of the building.

In the vertical lines, one group double and one single clamp should be used on each floor. In the horizontal lines, it is more suitable to use single clamp.

The test equipment in the institute laboratory is standard and the tests related to all waste water systems are conducted here. As seen in the test equipment below, pipe, fittings, installation wall thickness, water discharge amount as well as silent pipe clamp systems are also significant factors in the test report.



Clamp Details

The clamp on top, which is one of the double clamps used in the vertical lines, is fully tightened and grasps the pipe. The lower clamp is tightened up to the plastic wedges on the clamp. It is ensured that the rubber surfaces of the clamp are not jointed. In this system, the purpose is to absorb the vibration transmitted from waste water to pipe inside the first clamp and to minimize the vibration on the wall through the second clamp.

The single clamp in the vertical lines is tightened up to the plastic wedges on the clamp and it is ensured that the pipe is fixed to the wall. The single clamp in the horizontal lines is tightened up to the plastic wedges on the clamp and it is ensured that the pipe is fixed to the ceiling or wall.

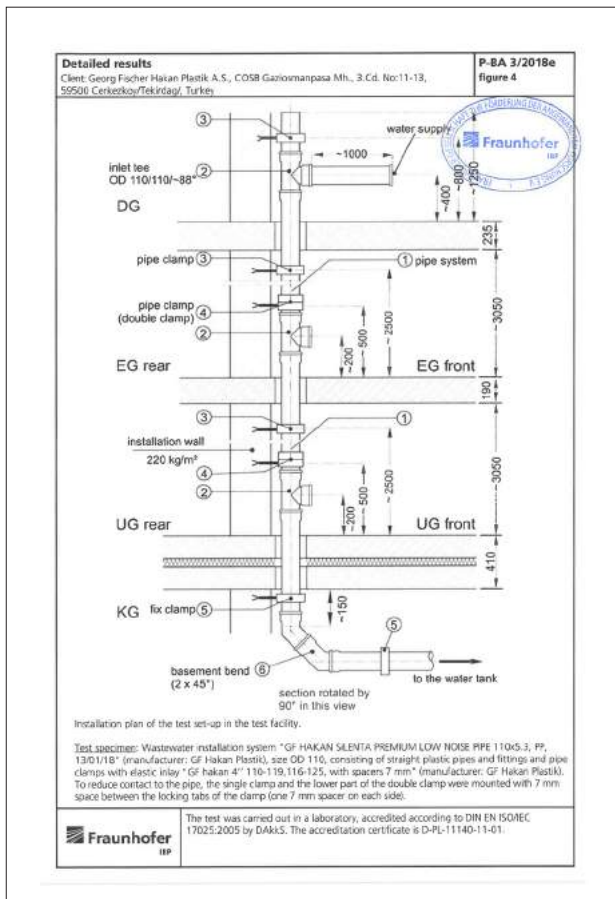

To achieve maximum acoustic performance, the silent pipe clamps used in the test should be used in the installations as well.

Although there are different types of silent pipe clamps, they are available in two kinds as fixed and movable.

The noise created in the waste water systems is transmitted by two methods as air born and structure born.

1- Sound waves transmitted through air cause pressure in the ambient and result in vibration on the objects and surfaces that they hit. Thanks to the special formulas used in GF Hakan Plastik Silenta products, these vibrations are absorbed and prevented from being transferred out of pipe.

2- Sound waves transmitted through contact occur as a result of the waste water and waste hitting the pipe wall. These vibrations are transferred on the wall of the installation through contact. The sound created by contact is significantly absorbed by the special molecular structure of Silenta and specially-designed GF Hakan silent clamps.

Installation

GF Hakan silent waste water pipe clamps ensure EN 14366 silence norms. In the waste water systems within buildings, correct clamps, their positions and distances are as important as silent pipes and fittings.

The clamp on top, which is one of the double clamps used in the vertical lines, is fully tightened and grasps the pipe. The lower clamp is tightened up to the plastic wedges on the clamp. It is ensured that the rubber surfaces of the clamp are not jointed. In this system, the purpose is to absorb the vibration transmitted from waste water to pipe inside the first clamp and to minimize the vibration on the wall through the second clamp.

The single clamp in the horizontal lines is tightened up to the plastic wedges on the clamp and it is ensured that the pipe is fixed to the ceiling or wall.

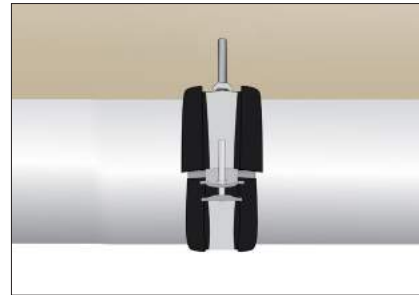
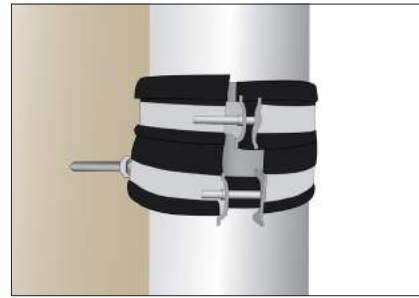

Worldwide at home

Our sales companies and representatives ensure local customer support in more than 100 countries.

www.gfps.com

Argentina / Southern South America

Georg Fischer Central Plastics Sudamérica S.R.L.
Buenos Aires / Argentina
Phone +54 11 4512 02 90
gfccentral.ps.ar@georgfischer.com
www.gfps.com/ar

Australia

George Fischer Pty Ltd
Riverwood NSW 2210
Phone +61 (0) 2 9502 8000
australia.ps@georgfischer.com
www.gfps.com/au

Austria

Georg Fischer Rohrleitungssysteme GmbH
3130 Herzogenburg
Phone +43 (0) 2782 856 43-0
austria.ps@georgfischer.com
www.gfps.com/at

Belgium / Luxembourg

Georg Fischer NV/SA
1600 Sint-Pieters-Leeuw / Belgium
Phone +32 (0) 2 556 40 20
Fax +32 (0) 2 524 34 26
be.ps@georgfischer.com
www.gfps.com/be

Brazil

Georg Fischer Sist. de Tub. Ltda.
04571-020 São Paulo/SP
Phone +55 (0) 11 5525 1311
br.ps@georgfischer.com
www.gfps.com/br

Canada

Georg Fischer Piping Systems Ltd
Mississauga, ON L5T 2B2
Phone +1 (905) 670 8005
Fax +1 (905) 670 8513
ca.ps@georgfischer.com
www.gfps.com/ca

China

Georg Fischer Piping Systems Ltd
Shanghai 201319
Phone +86 21 3899 3899
china.ps@georgfischer.com
www.gfps.com/cn

Denmark / Iceland

Georg Fischer A/S
2630 Taastrup / Denmark
Phone +45 (0) 70 22 19 75
info.dk.ps@georgfischer.com
www.gfps.com/dk

Finland

Georg Fischer AB
01510 Vantaa
Phone +358 (0) 9 586 58 25
Fax +358 (0) 9 586 58 29
info.fi.ps@georgfischer.com
www.gfps.com/fin

France

Georg Fischer SAS
95932 Roissy Charles de Gaulle Cedex
Phone +33 (0) 1 41 84 68 84
fr.ps@georgfischer.com
www.gfps.com/fr

Germany

Georg Fischer GmbH
73095 Albershausen
Phone +49 (0) 7161 302 0
info.de.ps@georgfischer.com
www.gfps.com/de

India

Georg Fischer Piping Systems Pvt. Ltd
400 083 Mumbai
Phone +91 22 4007 2000
Fax +91 22 4007 2020
branchoffice@georgfischer.com
www.gfps.com/in

Indonesia

PT Georg Fischer Indonesia
Karawang 41371, Jawa Barat
Phone +62 267 432 044
Fax +62 267 431 857
indonesia.ps@georgfischer.com
www.gfps.com/id

Italy

Georg Fischer S.p.A.
20864 Agrate Brianza (MB)
Phone +39 02 921 86 1
Fax +39 02 921 86 24 7
it.ps@georgfischer.com
www.gfps.com/it

Japan

Georg Fischer Ltd
530-0003 Osaka
Phone +81 (0) 6 6341 2451
jp.ps@georgfischer.com
www.gfps.com/jp

Korea

Georg Fischer Korea Co. Ltd
Unit 2501, U-Tower
120 Heungdeok Jungang-ro
(Yeongdeok-dong)
Giheung-gu, Yongin-si, Gyeonggi-do
Phone +82 31 8017 1450
Fax +82 31 217 1454
kor.ps@georgfischer.com
www.gfps.com/kr

Malaysia

Georg Fischer (M) Sdn. Bhd.
41200 Klang, Selangor Darul Ehsan
Phone +60 (0) 3 3122 5585
Fax +60 (0) 3 3122 5575
my.ps@georgfischer.com
www.gfps.com/my

Mexico / Northern Latin America

Georg Fischer S.A. de C.V.
CP 66603 Apodaca, Nuevo León / Mexico
Phone +52 (81) 1340 8586
Fax +52 (81) 1522 8906
mx.ps@georgfischer.com
www.gfps.com/mx

Middle East

Georg Fischer Piping Systems (Switzerland) Ltd
Dubai / United Arab Emirates
Phone +971 4 289 49 60
gcc.ps@georgfischer.com
www.gfps.com/int

Netherlands

Georg Fischer N.V.
8161 PA Epe
Phone +31 (0) 578 678 222
nl.ps@georgfischer.com
www.gfps.com/nl

New Zealand

Georg Fischer Ltd
5018 Upper Hutt
Phone +04 527 9813
Fax +04 527 9834
nz.ps@georgfischer.com
www.gfps.com/nz

Norway

Georg Fischer AS
1351 Rud
Phone +47 67 18 29 00
no.ps@georgfischer.com
www.gfps.com/no

Philippines

George Fischer Pte. Ltd.
Philippines Representative Office
1500 San Juan City
Phone +632 571 2365
Fax +632 571 2368
sgp.ps@georgfischer.com
www.gfps.com/sg

Poland

Georg Fischer Sp. z o.o.
05-090 Sekocin Nowy
Phone +48 (0) 22 31 31 0 50
poland.ps@georgfischer.com
www.gfps.com/pl

Romania

Georg Fischer Piping Systems (Switzerland) Ltd
020257 Bucharest - Sector 2
Phone +40 (0) 21 230 53 80
ro.ps@georgfischer.com
www.gfps.com/int

Russia

Georg Fischer Piping Systems (Switzerland) Ltd
Moscow 125040
Phone +7 495 748 11 44
ru.ps@georgfischer.com
www.gfps.com/ru

Singapore

George Fischer Pte Ltd
528 872 Singapore
Phone +65 6747 0611
Fax +65 6747 0577
sgp.ps@georgfischer.com
www.gfps.com/sg

Spain / Portugal

Georg Fischer S.A.
28046 Madrid / Spain
Phone +34 (0) 91 781 98 90
es.ps@georgfischer.com
www.gfps.com/es

Sweden

Georg Fischer AB
117 43 Stockholm
Phone +46 (0) 8 506 775 00
info.se.ps@georgfischer.com
www.gfps.com/se

Switzerland

Georg Fischer Rohrleitungssysteme (Schweiz) AG
8201 Schaffhausen
Phone +41 (0) 52 631 3026
ch.ps@georgfischer.com
www.gfps.com/ch

Taiwan

Georg Fischer Co. Ltd
San Chung Dist., New Taipei City
Phone +886 2 8512 2822
Fax +886 2 8512 2823
www.gfps.com/tw

United Kingdom / Ireland

George Fischer Sales Limited
Coventry, CV2 2ST / United Kingdom
Phone +44 (0) 2476 535 535
uk.ps@georgfischer.com
www.gfps.com/uk

USA / Caribbean

Georg Fischer LLC
92618 Irvine, CA / USA
Phone +1 714 731 8800
Fax +1 714 731 6201
us.ps@georgfischer.com
www.gfps.com/us

Vietnam

George Fischer Pte Ltd
Representative Office
Ho Chi Minh City
Phone +84 28 3948 4000
Fax +84 28 3948 4010
sgp.ps@georgfischer.com
www.gfps.com/vn

International

Georg Fischer Piping Systems (Switzerland) Ltd
8201 Schaffhausen / Switzerland
Phone +41 (0) 52 631 3003
Fax +41 (0) 52 631 2893
info.export@georgfischer.com
www.gfps.com/int

The information and technical data (altogether "Data") herein are not binding, unless explicitly confirmed in writing. The Data neither constitutes any expressed, implied or warranted characteristics, nor guaranteed properties or a guaranteed durability. All Data is subject to modification. The General Terms and Conditions of Sale of Georg Fischer Piping Systems apply.

Georg Fischer Hakan Plastik Boru ve Profil San. Tic. A.Ş.

www.gfps.com/tr

f t i YouTube in /gfhakanplastik

Regional Directorates

İstanbul

Ofishane Plaza
Merkez Mahallesi Cendere Caddesi
No:22 Kat:11
34400 Kağıthane / İSTANBUL
Tel: +90 212 809 20 33 (pbx)
Fax: +90 212 809 20 37

Antalya

İnci Plaza Yenigün Mh. 1054. Sok.
No:15 Ofis No:8
Muratpaşa / ANTALYA
Tel: +90 242 321 58 03
Fax: +90 242 321 58 53

Diyarbakır

Şanlıurfa Bulvarı Fırat Mh.
Ahmede Hani Cd. No:4
Yektower İş Merkezi No:13/39
Kayapınar / DİYARBAKIR
Tel: +90 412 251 18 20
Fax: +90 412 251 18 25

Samsun

Kuzey Yıldızı Mah. 100.Yıl Bulv.
No:38 Kat:4 Daire:23 Baran Plaza
Canik / SAMSUN
Tel: +90 362 256 02 33 - 03 33

Ankara

Mustafa Kemal Mahallesi
2131. Cadde Akay İş Merkezi 30-9
Çankaya / ANKARA

Production Facilities

Tekirdağ / Çerkezköy

Organize San. Bölgesi Gaziosmanpaşa
Mh. 3. Cd. No:11-13
Çerkezköy / TEKİRDAĞ
Tel: +90 282 726 64 43 (pbx)
Fax: +90 282 726 99 33

Şanlıurfa

Şanlıurfa-Gaziantep Karayolu 16. Km
2. Organize San. Bölgesi 1. Cd. No:3
ŞANLIURFA
Tel: +90 414 369 18 30
Fax: +90 414 369 17 96

