

Uponor Smatrix Base/Base PRO

NL Installatierapport

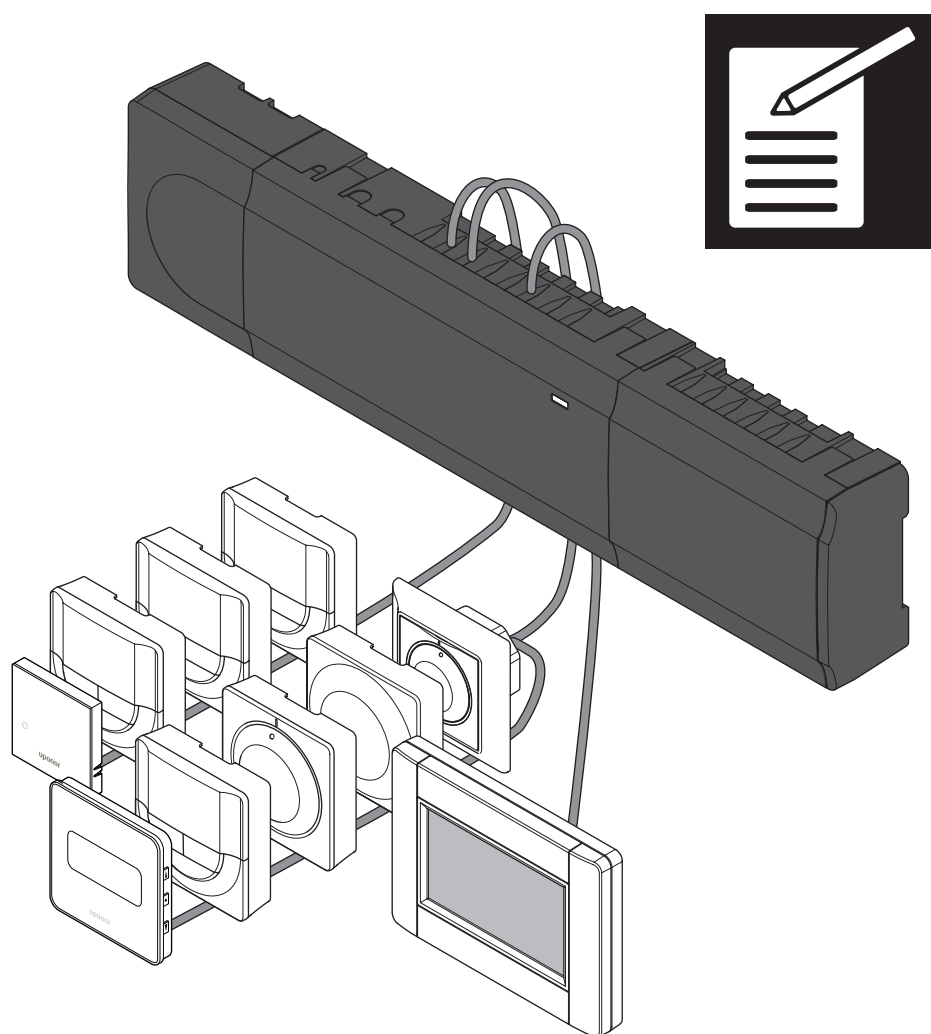

Installatierapport

NL

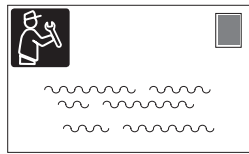
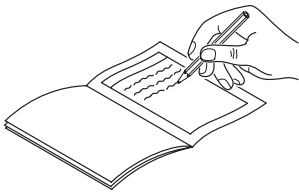

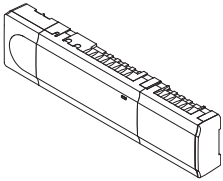
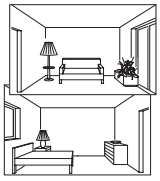

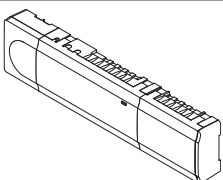
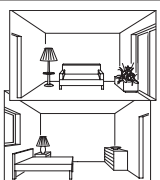





	Regelmodule								
	#1	#2	#3	#4	#5	#6	#7	#8	
Geregistreerd systeemapparaat									Ruimtenaam
Bedieningsmodule									
Timer									
Buitenvoeler									
Schakelvoeler verwarmen/koelen									
Schakelaar ECO/ Comfort									
Pomp	Ja <input type="checkbox"/>	Ja <input type="checkbox"/>	Ja <input type="checkbox"/>	Ja <input type="checkbox"/>	Ja <input type="checkbox"/>	Ja <input type="checkbox"/>	Ja <input type="checkbox"/>	Ja <input type="checkbox"/>	
	Nee <input type="checkbox"/>	Nee <input type="checkbox"/>	Nee <input type="checkbox"/>	Nee <input type="checkbox"/>	Nee <input type="checkbox"/>	Nee <input type="checkbox"/>	Nee <input type="checkbox"/>	Nee <input type="checkbox"/>	
Stermodule	Ja <input type="checkbox"/>	Ja <input type="checkbox"/>	Ja <input type="checkbox"/>	Ja <input type="checkbox"/>	Ja <input type="checkbox"/>	Ja <input type="checkbox"/>	Ja <input type="checkbox"/>	Ja <input type="checkbox"/>	
	Nee <input type="checkbox"/>	Nee <input type="checkbox"/>	Nee <input type="checkbox"/>	Nee <input type="checkbox"/>	Nee <input type="checkbox"/>	Nee <input type="checkbox"/>	Nee <input type="checkbox"/>	Nee <input type="checkbox"/>	

	Regelmodule								
	#9	#10	#11	#12	#13	#14	#15	#16	
Geregistreerd systeemapparaat									Ruimtenaam
Bedieningsmodule									
Pomp	Ja <input type="checkbox"/>	Ja <input type="checkbox"/>	Ja <input type="checkbox"/>	Ja <input type="checkbox"/>	Ja <input type="checkbox"/>	Ja <input type="checkbox"/>	Ja <input type="checkbox"/>	Ja <input type="checkbox"/>	
	Nee <input type="checkbox"/>	Nee <input type="checkbox"/>	Nee <input type="checkbox"/>	Nee <input type="checkbox"/>	Nee <input type="checkbox"/>	Nee <input type="checkbox"/>	Nee <input type="checkbox"/>	Nee <input type="checkbox"/>	
Stermodule	Ja <input type="checkbox"/>	Ja <input type="checkbox"/>	Ja <input type="checkbox"/>	Ja <input type="checkbox"/>	Ja <input type="checkbox"/>	Ja <input type="checkbox"/>	Ja <input type="checkbox"/>	Ja <input type="checkbox"/>	
	Nee <input type="checkbox"/>	Nee <input type="checkbox"/>	Nee <input type="checkbox"/>	Nee <input type="checkbox"/>	Nee <input type="checkbox"/>	Nee <input type="checkbox"/>	Nee <input type="checkbox"/>	Nee <input type="checkbox"/>	

Regelmodule 1

NL

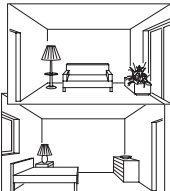
Ruimtethermostaat	Kanaal regelmodule						Uitbreidingsmodulekanaal					
	1	2	3	4	5	6	7	8	9	10	11	12
 T-149												
 T-148												
 T-146												
 T-145												
 T-144												
 T-143												
 T-141												
Verbonden externe voeler												
Vloervoeler												
Buitenvoeler												
Externe voeler												
Aangesloten thermische aandrijving												
												
Ruimtenaam												
												



.....

.....

.....









.....

.....

.....

Regelmodule 2

NL

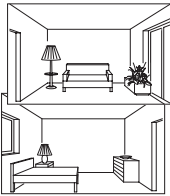
Ruimtethermostaat	Kanaal regelmodule						Uitbreidingsmodulekanaal					
	1	2	3	4	5	6	7	8	9	10	11	12
 T-149												
 T-148												
 T-146												
 T-145												
 T-144												
 T-143												
 T-141												
Verbonden externe voeler												
Vloervoeler												
Buitenvoeler												
Externe voeler												
Aangesloten thermische aandrijving												
												
Ruimtenaam												
												



.....

.....

.....

.....









.....

.....

.....

Regelmodule 3

NL

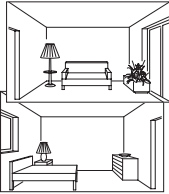
Ruimtethermostaat	Kanaal regelmodule						Uitbreidingsmodulekanaal					
	1	2	3	4	5	6	7	8	9	10	11	12
 T-149												
 T-148												
 T-146												
 T-145												
 T-144												
 T-143												
 T-141												
Verbonden externe voeler												
Vloervoeler												
Buitenvoeler												
Externe voeler												
Aangesloten thermische aandrijving												
												
Ruimtenaam												
												



.....

.....

.....









.....

.....

.....

Regelmodule 4

NL

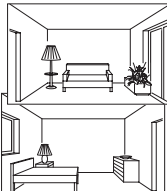
Ruimtethermostaat	Kanaal regelmodule						Uitbreidingsmodulekanaal					
	1	2	3	4	5	6	7	8	9	10	11	12
 T-149												
 T-148												
 T-146												
 T-145												
 T-144												
 T-143												
 T-141												
Verbonden externe voeler												
Vloervoeler												
Buitenvoeler												
Externe voeler												
Aangesloten thermische aandrijving												
												
Ruimtenaam												
												



.....

.....

.....

.....









.....

.....

Regelmodule 5 – 16

Gebruik deze pagina als sjabloon voor Smatrix Base PRO-regelmodules 5 – 16

NL

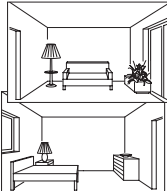
Ruimtethermostaat	Kanaal regelmodule						Uitbreidingsmodulekanaal					
	1	2	3	4	5	6	7	8	9	10	11	12
 T-149												
 T-148												
 T-146												
 T-145												
 T-144												
 T-143												
 T-141												
Verbonden externe voeler												
Vloervoeler												
Buitervoeler												
Externe voeler												
Aangesloten thermische aandrijving												
												
Ruimtenaam												
												



.....

.....

.....

.....

.....

.....

Nathan Systems

Mega 2
6902 KL in Zevenaar

1143283 v1_11_2023_NL
Production: Uponor / ELO

Uponor behoudt zich het recht voor om het productportfolio en de
bijbehorende documentatie te wijzigen overeenkomstig het beleid
van continue verbeteringen en ontwikkelingen.

