

Uponor Minitec

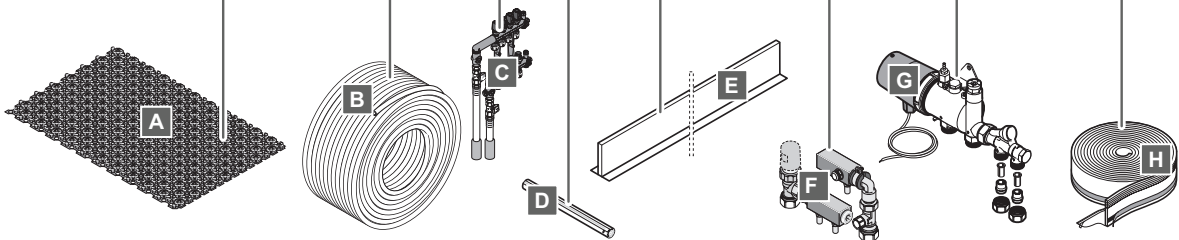

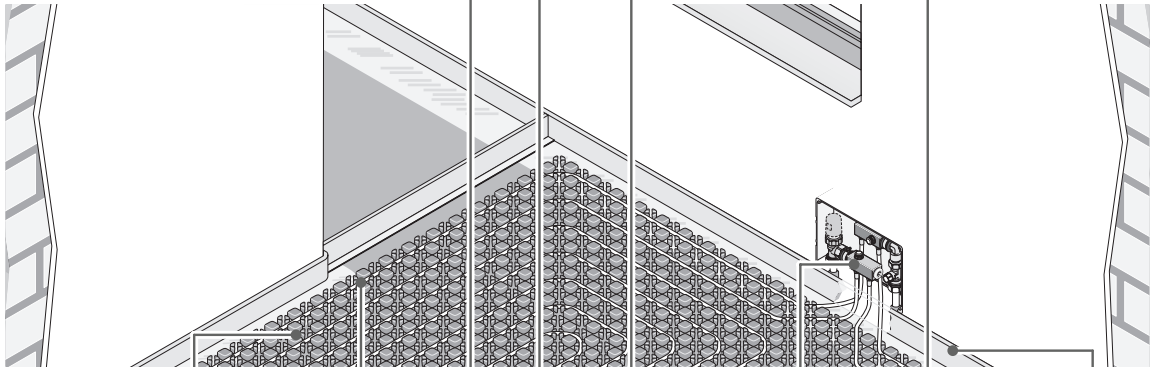
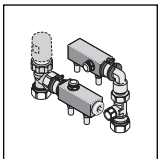
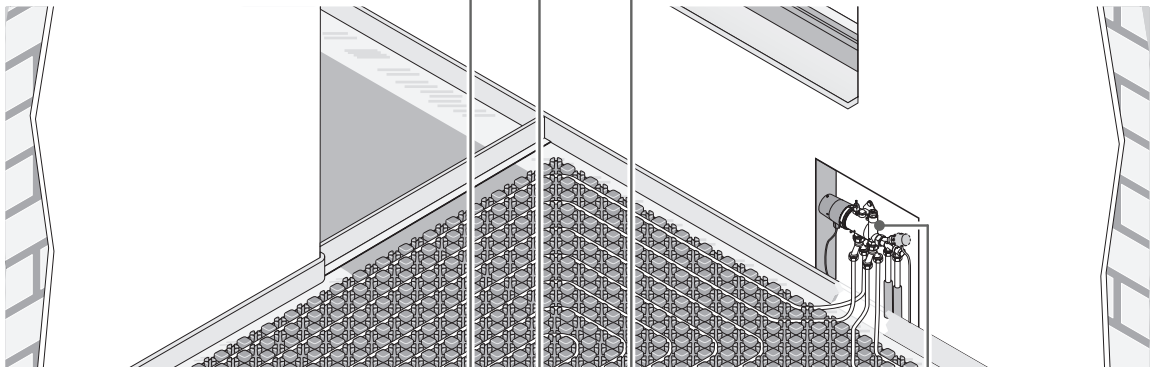
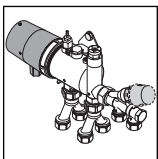
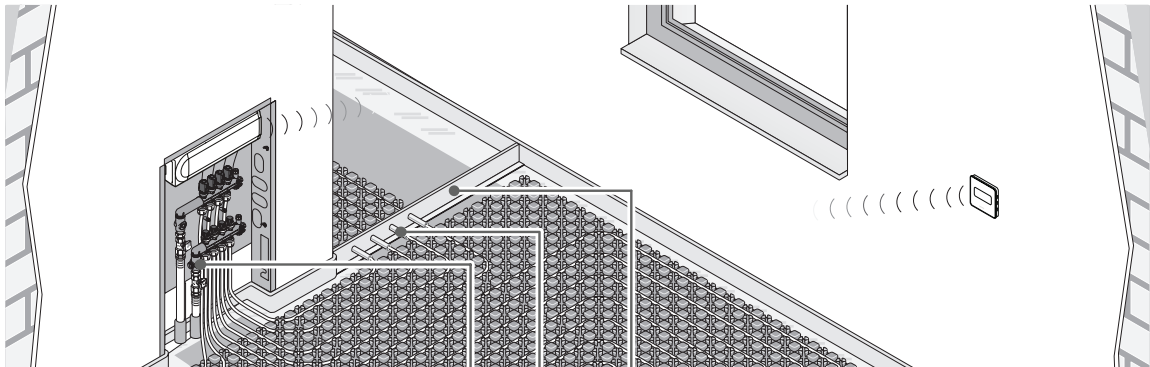
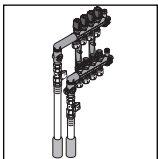
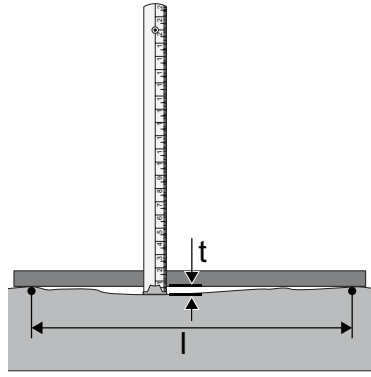
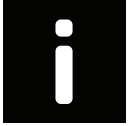

EN 18202

l (m)	0,1	1	4	10	15
t (mm)	1	3	9	12	15

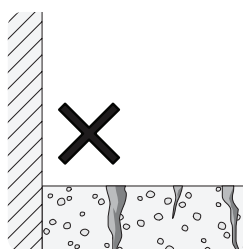
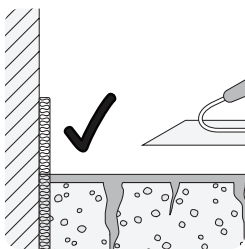
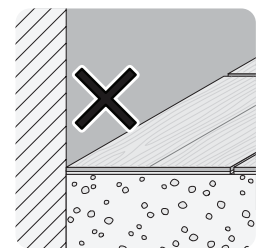
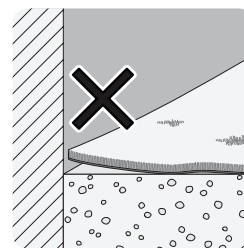
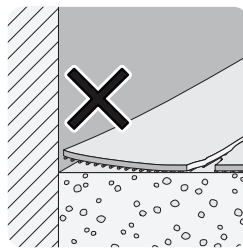
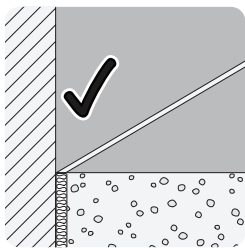
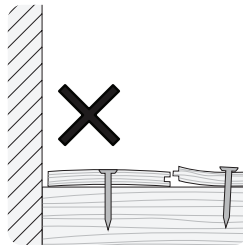
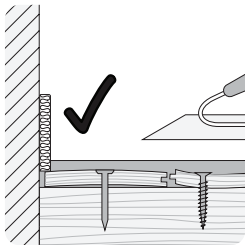
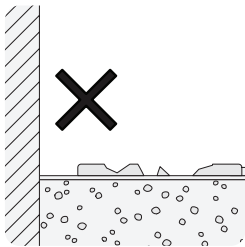
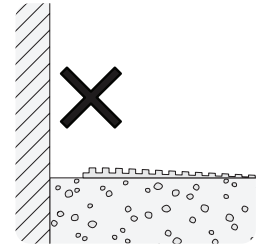
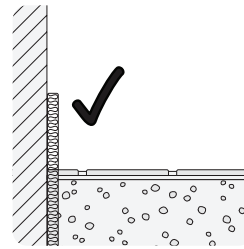
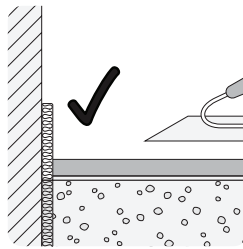
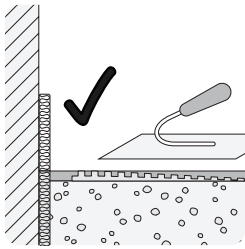

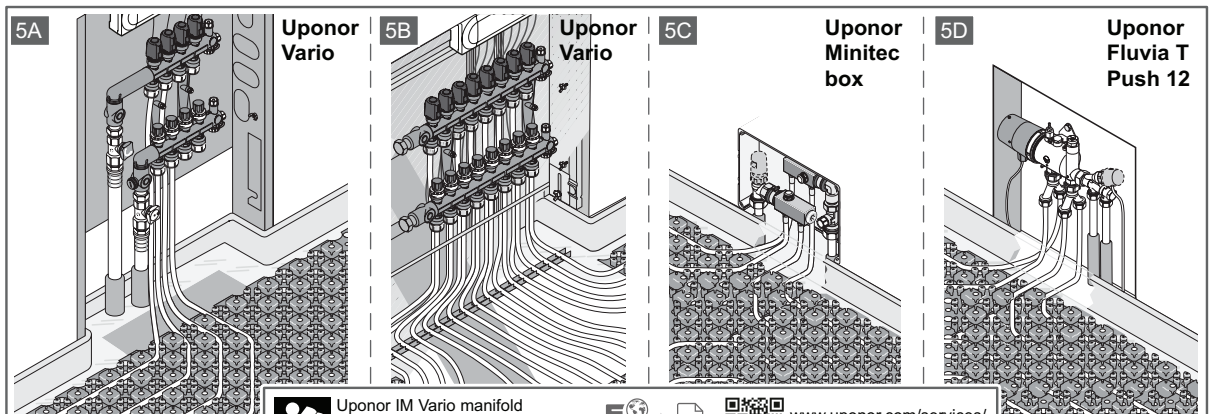
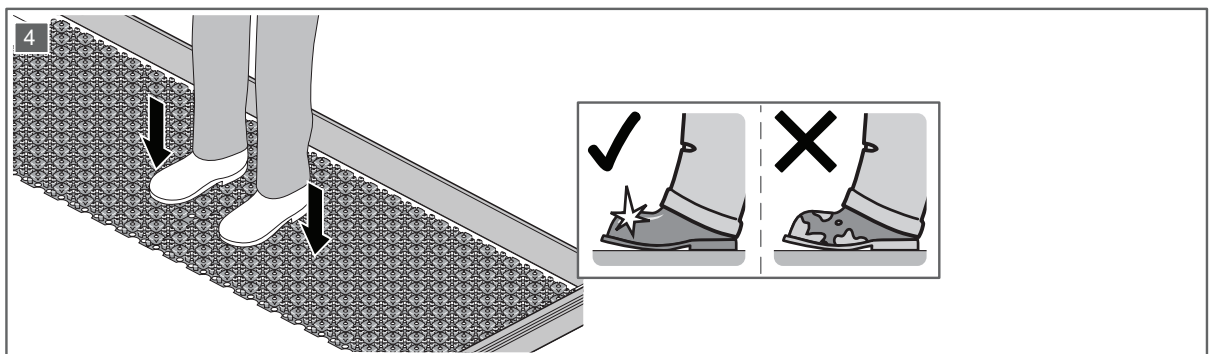
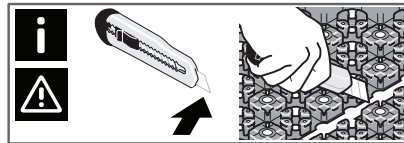
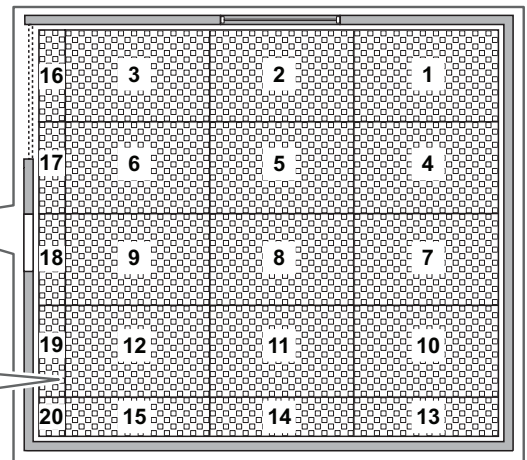
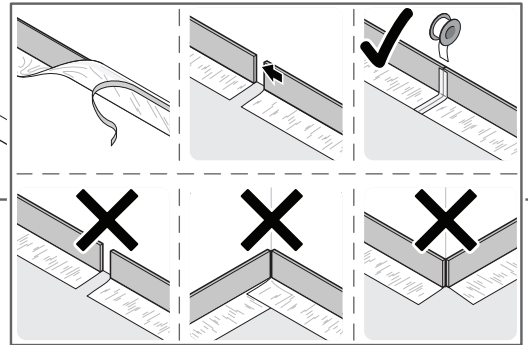
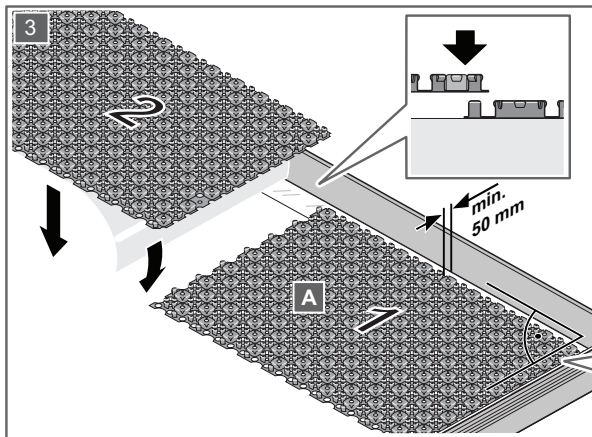
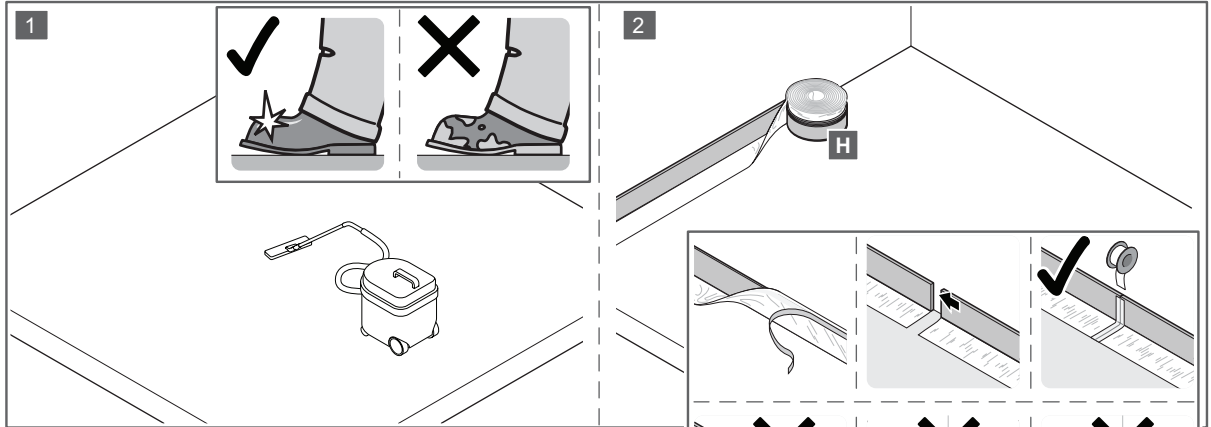
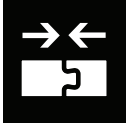

Uponor IM Vario manifold
Uponor IM Fluvia T Push 12
Uponor IM Minitec connection box

www.uponor.com/services/download-centre

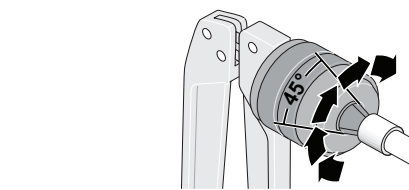
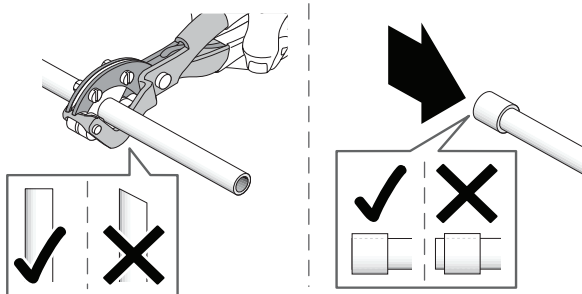
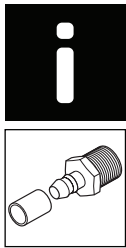

Uponor IM
Q&E [www.uponor.com/
services/download-centre](http://www.uponor.com/services/download-centre)

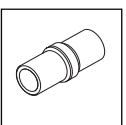
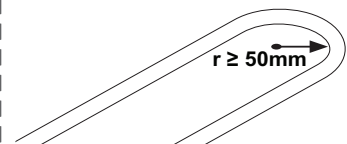
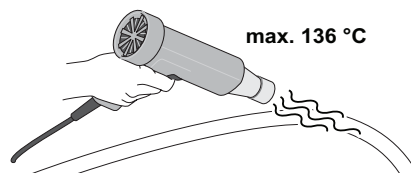
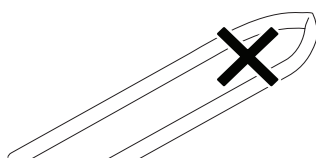
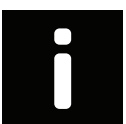
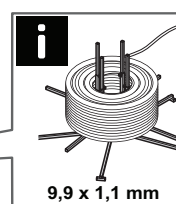
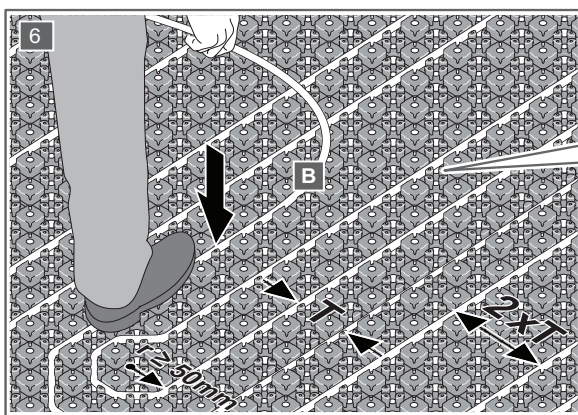
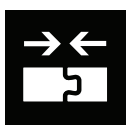
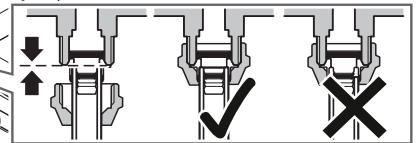
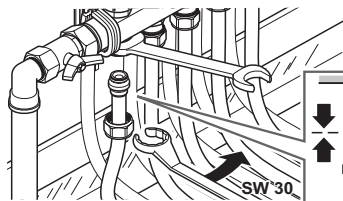
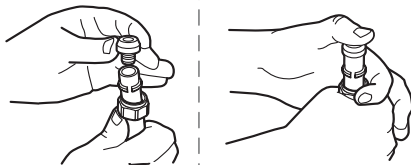
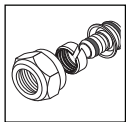

EN 1264

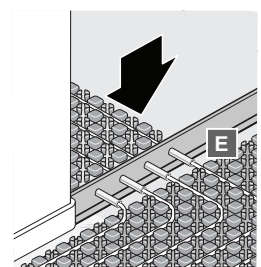
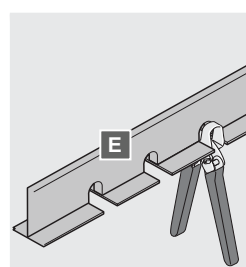
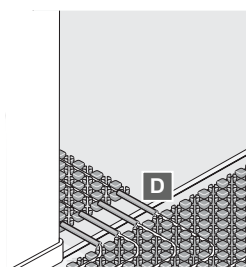
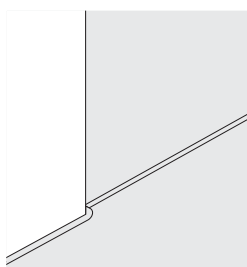
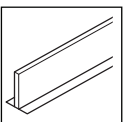
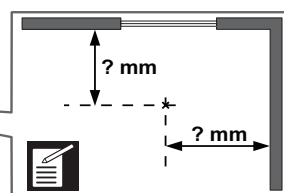
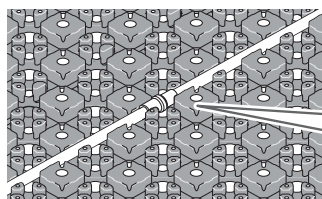

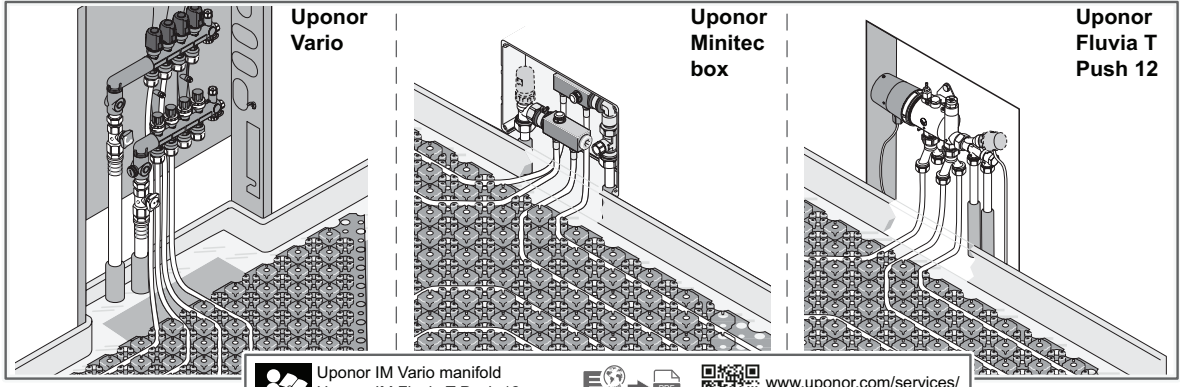



 Uponor IM Vario manifold
 Uponor IM Fluvia T Push 12
 Uponor IM Minitec connection box

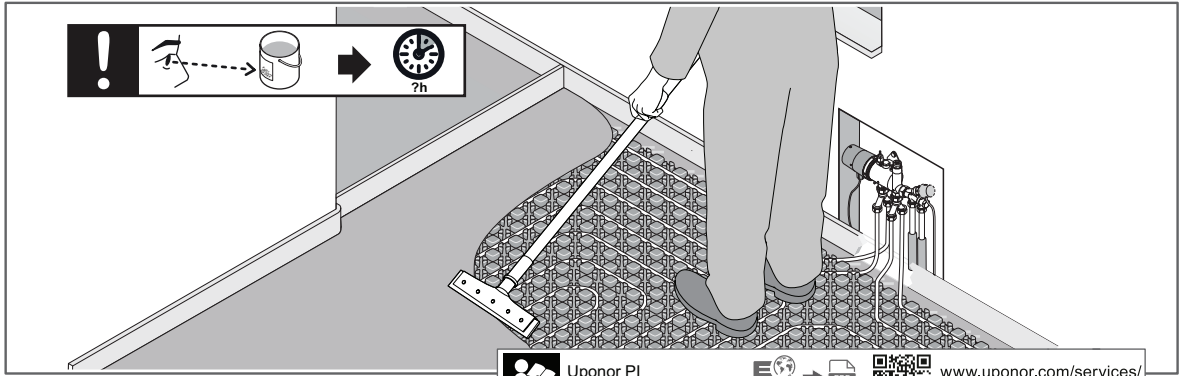
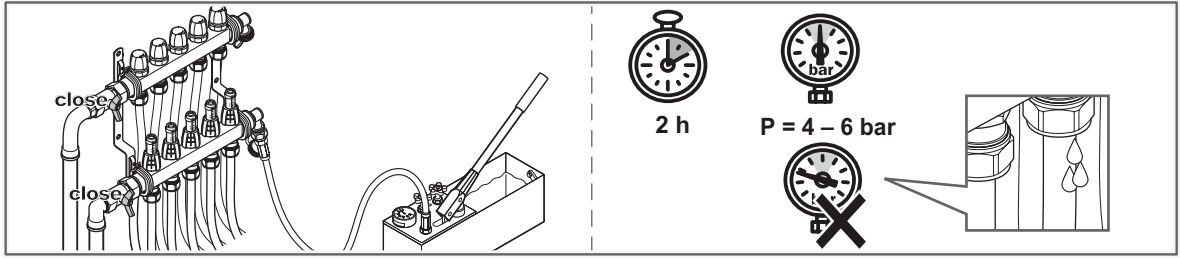

www.uponor.com/services/download-centre



 Uponor P1
 Minitec levelling material



www.uponor.com/services/download-centre

Uponor GmbH

Industriestraße 56,
 D-97437 Hassfurt, Germany

1022253 v2_02_2025
 Production: Uponor / SKA_ASP

Uponor reserves the right to make changes, without prior notification,
 to the specification of incorporated components in line with its policy
 of continuous improvement and development.



www.uponor.com