

## Uponor Smatrix Base/Base PRO

UK Installation report

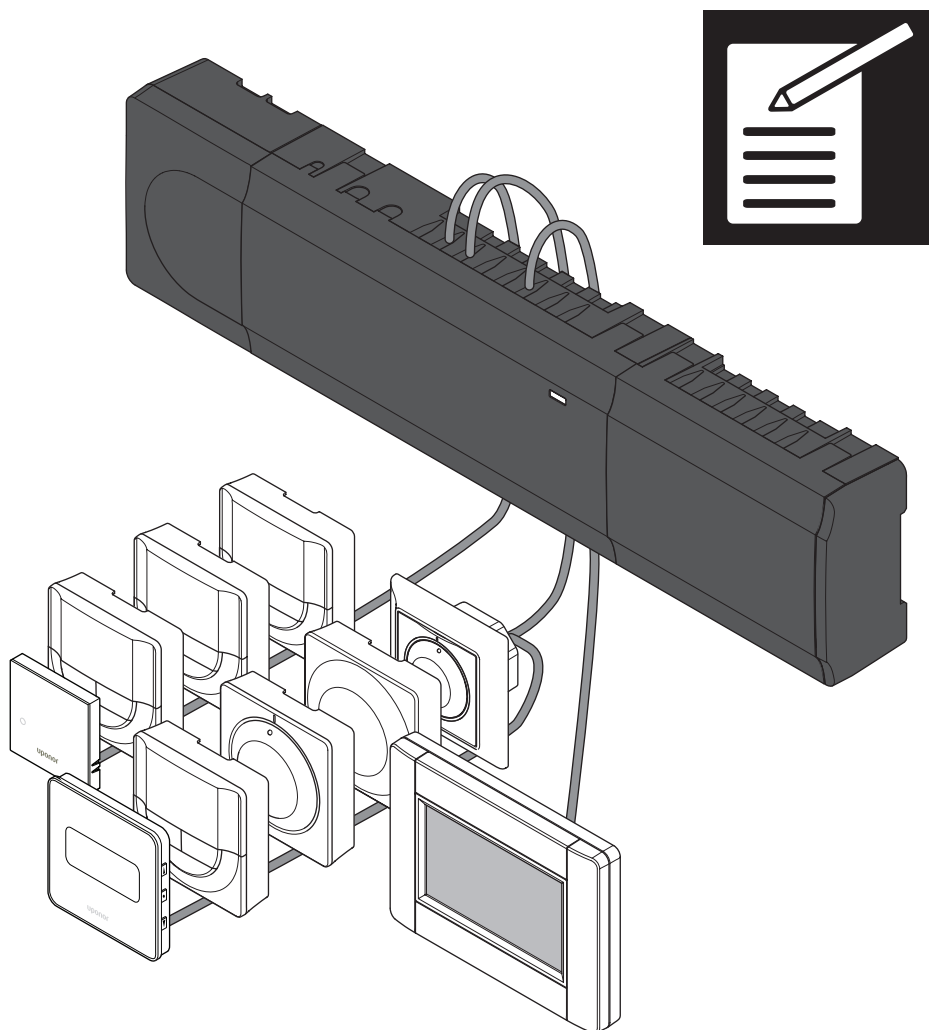

# System overview

UK

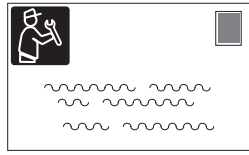
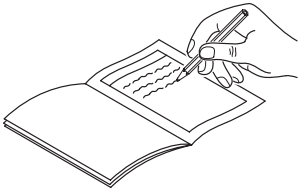

---



---



---





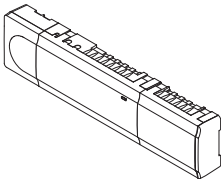
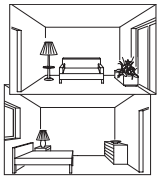

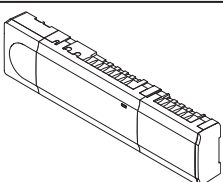
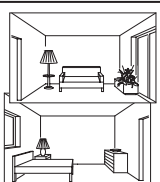



---

	Controller								
	# 1	# 2	# 3	# 4	# 5	# 6	# 7	# 8	
<b>Registered system device</b>									<b>Room name</b>
Interface									
Timer									
Outdoor sensor									
Heating/cooling switch sensor									
ECO/Comfort switch									
Pump	Yes <input type="checkbox"/>	Yes <input type="checkbox"/>	Yes <input type="checkbox"/>	Yes <input type="checkbox"/>	Yes <input type="checkbox"/>	Yes <input type="checkbox"/>	Yes <input type="checkbox"/>	Yes <input type="checkbox"/>	
	No <input type="checkbox"/>	No <input type="checkbox"/>	No <input type="checkbox"/>	No <input type="checkbox"/>	No <input type="checkbox"/>	No <input type="checkbox"/>	No <input type="checkbox"/>	No <input type="checkbox"/>	
Star module	Yes <input type="checkbox"/>	Yes <input type="checkbox"/>	Yes <input type="checkbox"/>	Yes <input type="checkbox"/>	Yes <input type="checkbox"/>	Yes <input type="checkbox"/>	Yes <input type="checkbox"/>	Yes <input type="checkbox"/>	
	No <input type="checkbox"/>	No <input type="checkbox"/>	No <input type="checkbox"/>	No <input type="checkbox"/>	No <input type="checkbox"/>	No <input type="checkbox"/>	No <input type="checkbox"/>	No <input type="checkbox"/>	

	Controller								
	# 9	# 10	# 11	# 12	# 13	# 14	# 15	# 16	
<b>Registered system device</b>									<b>Room name</b>
Interface									
Pump	Yes <input type="checkbox"/>	Yes <input type="checkbox"/>	Yes <input type="checkbox"/>	Yes <input type="checkbox"/>	Yes <input type="checkbox"/>	Yes <input type="checkbox"/>	Yes <input type="checkbox"/>	Yes <input type="checkbox"/>	
	No <input type="checkbox"/>	No <input type="checkbox"/>	No <input type="checkbox"/>	No <input type="checkbox"/>	No <input type="checkbox"/>	No <input type="checkbox"/>	No <input type="checkbox"/>	No <input type="checkbox"/>	
Star module	Yes <input type="checkbox"/>	Yes <input type="checkbox"/>	Yes <input type="checkbox"/>	Yes <input type="checkbox"/>	Yes <input type="checkbox"/>	Yes <input type="checkbox"/>	Yes <input type="checkbox"/>	Yes <input type="checkbox"/>	
	No <input type="checkbox"/>	No <input type="checkbox"/>	No <input type="checkbox"/>	No <input type="checkbox"/>	No <input type="checkbox"/>	No <input type="checkbox"/>	No <input type="checkbox"/>	No <input type="checkbox"/>	

# Controller 1

UK

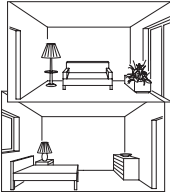
Thermostat	Controller channel						Extension module channel					
	1	2	3	4	5	6	7	8	9	10	11	12
 T-149												
 T-148												
 T-146												
 T-145												
 T-144												
 T-143												
 T-141												
<b>Connected external sensor</b>												
Floor sensor												
Outdoor sensor												
Remote sensor												
<b>Connected actuator</b>												
												
<b>Room name</b>												
												



.....

.....

.....









.....

.....

.....

# Controller 2

UK

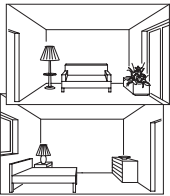
Thermostat	Controller channel						Extension module channel					
	1	2	3	4	5	6	7	8	9	10	11	12
 T-149												
 T-148												
 T-146												
 T-145												
 T-144												
 T-143												
 T-141												
<b>Connected external sensor</b>												
Floor sensor												
Outdoor sensor												
Remote sensor												
<b>Connected actuator</b>												
												
<b>Room name</b>												
												



.....

.....

.....









.....

.....

.....

# Controller 3

UK

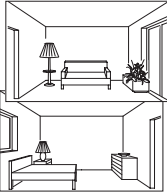
Thermostat	Controller channel						Extension module channel					
	1	2	3	4	5	6	7	8	9	10	11	12
 T-149												
 T-148												
 T-146												
 T-145												
 T-144												
 T-143												
 T-141												
<b>Connected external sensor</b>												
Floor sensor												
Outdoor sensor												
Remote sensor												
<b>Connected actuator</b>												
												
<b>Room name</b>												
												



.....

.....

.....









.....

.....

.....

# Controller 4

UK

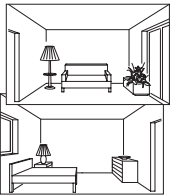
Thermostat	Controller channel						Extension module channel					
	1	2	3	4	5	6	7	8	9	10	11	12
 T-149												
 T-148												
 T-146												
 T-145												
 T-144												
 T-143												
 T-141												
<b>Connected external sensor</b>												
Floor sensor												
Outdoor sensor												
Remote sensor												
<b>Connected actuator</b>												
												
<b>Room name</b>												
												



.....

.....

.....

.....









.....

.....

# Controller 5 – 16

Use this page as a template for Smatrix Base PRO controllers 5 – 16

UK

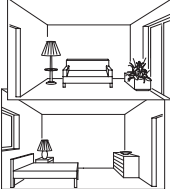
Thermostat	Controller channel						Extension module channel					
	1	2	3	4	5	6	7	8	9	10	11	12
 T-149												
 T-148												
 T-146												
 T-145												
 T-144												
 T-143												
 T-141												
<b>Connected external sensor</b>												
Floor sensor												
Outdoor sensor												
Remote sensor												
<b>Connected actuator</b>												
												
<b>Room name</b>												
												



.....

.....

.....

.....

.....

.....



**Uponor Ltd**

The Pavilion, Blackmoor Lane  
Watford, Hertfordshire  
WD18 8GA

1143292 v1\_11\_2023\_UK  
Production: Uponor / ELO

Uponor reserves the right to change the product portfolio and the related documentation without prior notification, in line with its policy of continuous improvement and development.



[www.uponor.com/en-gb](http://www.uponor.com/en-gb)