

## Uponor Smatrix Base/Base PRO

FI Asennusraportti

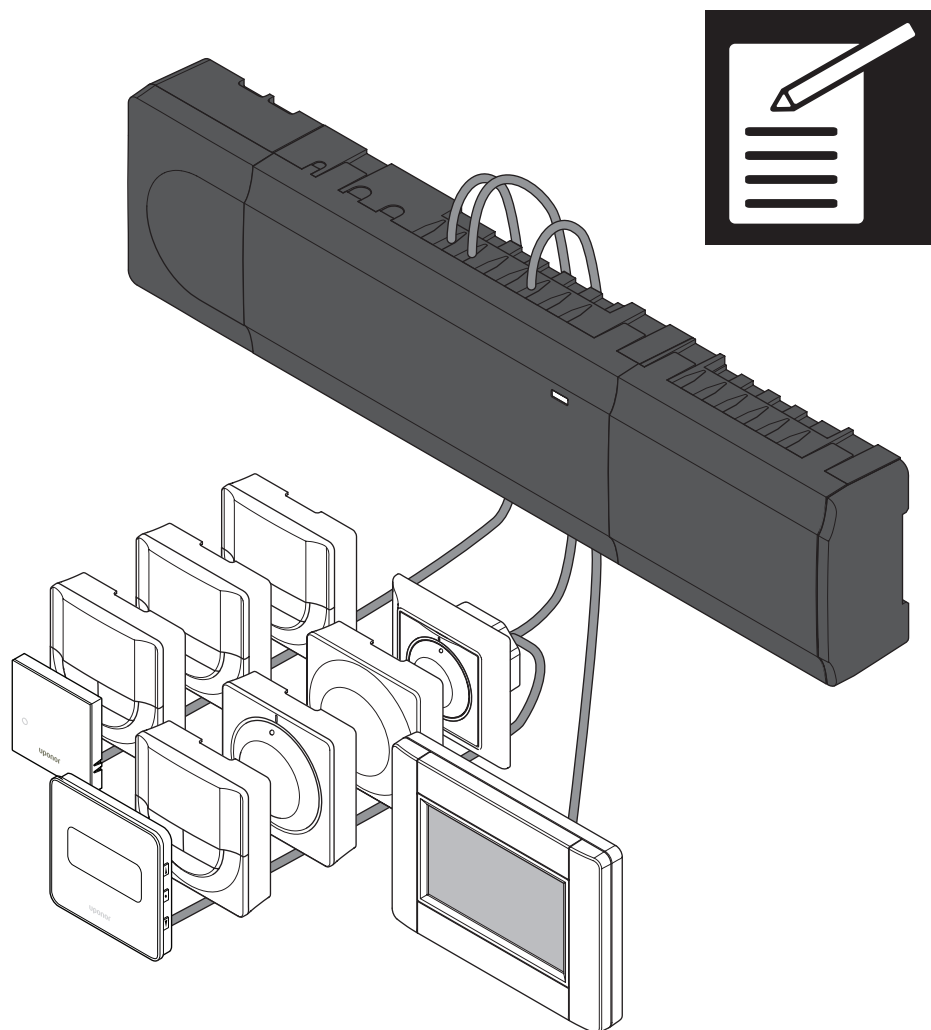

# Asennusraportti

FI

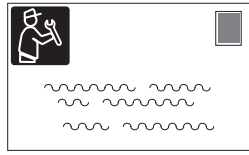
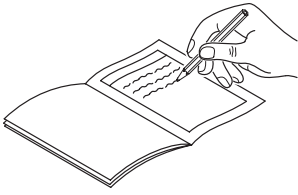

---





---



---



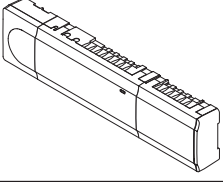



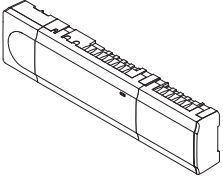
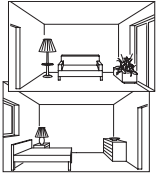



---

	Keskusyksikkö								
	# 1	# 2	# 3	# 4	# 5	# 6	# 7	# 8	
<b>Rekisteröity järjestelmälaite</b>									<b>Huoneen nimi</b>
Käyttöpaneeli									
Ajastin									
Ulkoanturi									
Lämmitys/viilennys- kytkennän anturi									
ECO/Comfort- kytkentä									
Pumppu	Kyllä <input type="checkbox"/>	Kyllä <input type="checkbox"/>	Kyllä <input type="checkbox"/>	Kyllä <input type="checkbox"/>	Kyllä <input type="checkbox"/>	Kyllä <input type="checkbox"/>	Kyllä <input type="checkbox"/>	Kyllä <input type="checkbox"/>	
	Ei <input type="checkbox"/>	Ei <input type="checkbox"/>	Ei <input type="checkbox"/>	Ei <input type="checkbox"/>	Ei <input type="checkbox"/>	Ei <input type="checkbox"/>	Ei <input type="checkbox"/>	Ei <input type="checkbox"/>	
Tähtikytkentä- moduuli	Kyllä <input type="checkbox"/>	Kyllä <input type="checkbox"/>	Kyllä <input type="checkbox"/>	Kyllä <input type="checkbox"/>	Kyllä <input type="checkbox"/>	Kyllä <input type="checkbox"/>	Kyllä <input type="checkbox"/>	Kyllä <input type="checkbox"/>	
	Ei <input type="checkbox"/>	Ei <input type="checkbox"/>	Ei <input type="checkbox"/>	Ei <input type="checkbox"/>	Ei <input type="checkbox"/>	Ei <input type="checkbox"/>	Ei <input type="checkbox"/>	Ei <input type="checkbox"/>	

	Keskusyksikkö								
	# 9	# 10	# 11	# 12	# 13	# 14	# 15	# 16	
<b>Rekisteröity järjestelmälaite</b>									<b>Huoneen nimi</b>
Käyttöpaneeli									
Pumppu	Kyllä <input type="checkbox"/>	Kyllä <input type="checkbox"/>	Kyllä <input type="checkbox"/>	Kyllä <input type="checkbox"/>	Kyllä <input type="checkbox"/>	Kyllä <input type="checkbox"/>	Kyllä <input type="checkbox"/>	Kyllä <input type="checkbox"/>	
	Ei <input type="checkbox"/>	Ei <input type="checkbox"/>	Ei <input type="checkbox"/>	Ei <input type="checkbox"/>	Ei <input type="checkbox"/>	Ei <input type="checkbox"/>	Ei <input type="checkbox"/>	Ei <input type="checkbox"/>	
Tähtikytkentä- moduuli	Kyllä <input type="checkbox"/>	Kyllä <input type="checkbox"/>	Kyllä <input type="checkbox"/>	Kyllä <input type="checkbox"/>	Kyllä <input type="checkbox"/>	Kyllä <input type="checkbox"/>	Kyllä <input type="checkbox"/>	Kyllä <input type="checkbox"/>	
	Ei <input type="checkbox"/>	Ei <input type="checkbox"/>	Ei <input type="checkbox"/>	Ei <input type="checkbox"/>	Ei <input type="checkbox"/>	Ei <input type="checkbox"/>	Ei <input type="checkbox"/>	Ei <input type="checkbox"/>	

# Keskusyksikkö 1

FI

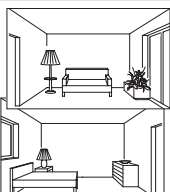
Termostaatti	Keskusyksikön kanava						Lisäosan kanava					
	1	2	3	4	5	6	7	8	9	10	11	12
 T-149												
 T-148												
 T-146												
 T-145												
 T-144												
 T-143												
 T-141												
<b>Liitetty ulkoinen anturi.</b>												
Lattia-anturi												
Ulkoanturi												
Etäanturi												
<b>Liitetty toimilaite</b>												
												
<b>Huoneen nimi</b>												
												



.....

.....

.....









.....

.....

.....

# Keskusyksikkö 2

FI

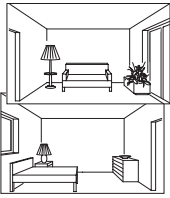
Termostaatti	Keskusyksikön kanava						Lisäosan kanava					
	1	2	3	4	5	6	7	8	9	10	11	12
 T-149												
 T-148												
 T-146												
 T-145												
 T-144												
 T-143												
 T-141												
<b>Liitetty ulkoinen anturi.</b>												
Lattia-anturi												
Ulkoanturi												
Etäanturi												
<b>Liitetty toimilaite</b>												
												
<b>Huoneen nimi</b>												
												



.....

.....

.....









.....

.....

.....

# Keskusyksikkö 3

FI

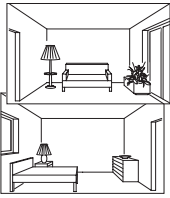
Termostaatti	Keskusyksikön kanava						Lisäosan kanava					
	1	2	3	4	5	6	7	8	9	10	11	12
 T-149												
 T-148												
 T-146												
 T-145												
 T-144												
 T-143												
 T-141												
<b>Liitetty ulkoinen anturi.</b>												
Lattia-anturi												
Ulkoanturi												
Etäanturi												
<b>Liitetty toimilaite</b>												
												
<b>Huoneen nimi</b>												
												



.....

.....

.....









.....

.....

.....

# Keskusyksikkö 4

FI

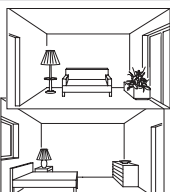
Termostaatti	Keskusyksikön kanava						Lisäosan kanava					
	1	2	3	4	5	6	7	8	9	10	11	12
 T-149												
 T-148												
 T-146												
 T-145												
 T-144												
 T-143												
 T-141												
<b>Liitetty ulkoinen anturi.</b>												
Lattia-anturi												
Ulkoanturi												
Etäanturi												
<b>Liitetty toimilaite</b>												
												
<b>Huoneen nimi</b>												
												



.....

.....

.....

.....









.....

.....

# Keskusyksikkö 5 – 16

Käytä tätä sivua mallipohjana Smatrix Base PRO -keskusyksiköille 5 – 16

FI

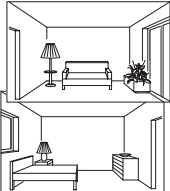
Termostaatti	Keskusyksikön kanava						Lisäosan kanava					
	1	2	3	4	5	6	7	8	9	10	11	12
 T-149												
 T-148												
 T-146												
 T-145												
 T-144												
 T-143												
 T-141												
<b>Liitetty ulkoinen anturi.</b>												
Lattia-anturi												
Ulkoanturi												
Etäanturi												
<b>Liitetty toimilaite</b>												
												
<b>Huoneen nimi</b>												
												



.....

.....

.....

.....

.....

.....

# Uponor

## Uponor Suomi Oy

PL 21

15561 Nastola

1143276 v1\_11\_2023\_FI  
Production: Uponor / ELO

Uponor pidättää oikeuden muuttaa tuotevalikoimaa ja siihen liittyviä asiakirjoja ilman ennakoilmoitusta tuotteiden jatkuvaan parantamiseen ja kehittämiseen liittyvien toimintaperiaatteidensa mukaisesti.



[www.uponor.com/fi-fi](http://www.uponor.com/fi-fi)