

Uponor Smatrix Base/Base PRO

ES Informe de instalación

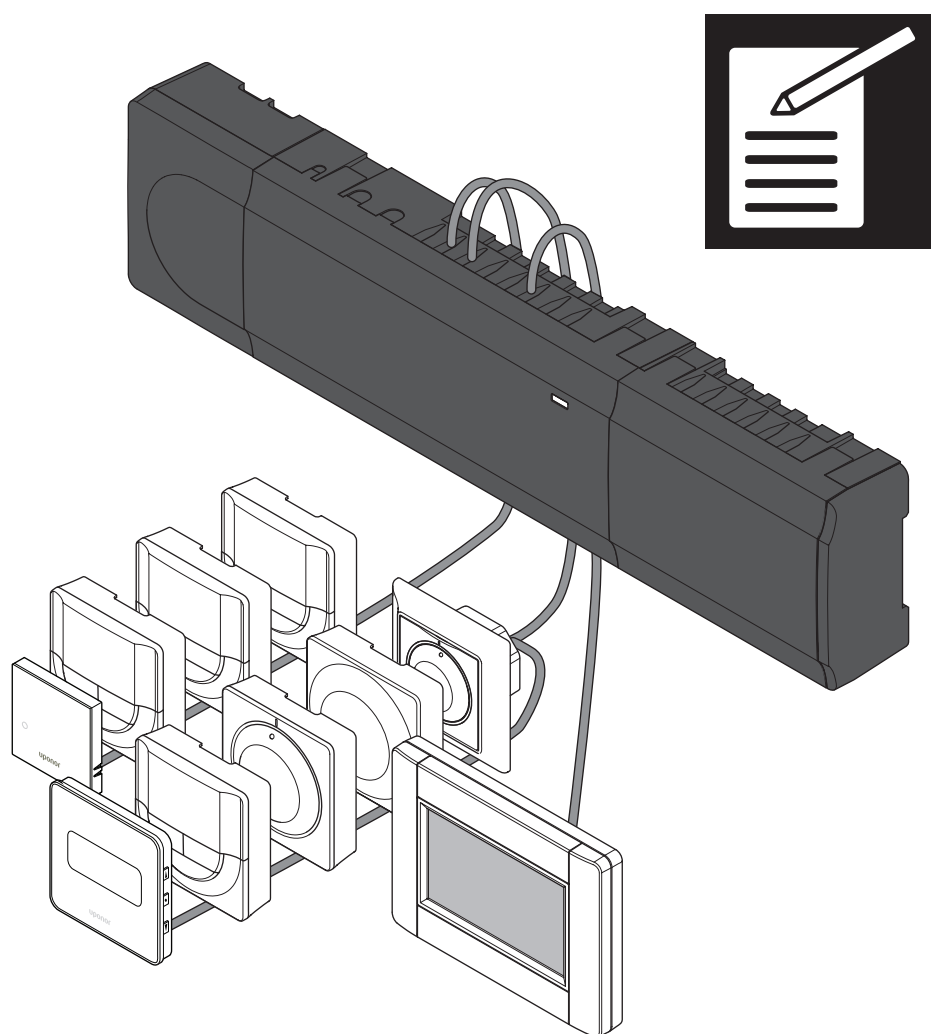

Informe de instalación

ES

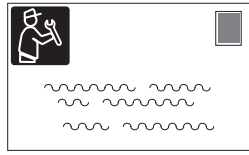
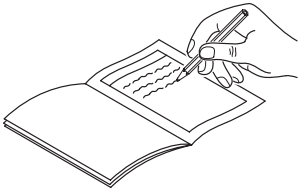

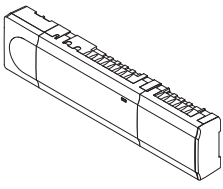
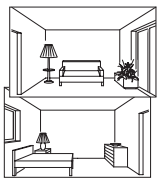

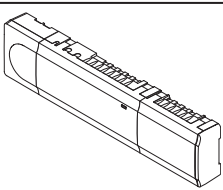
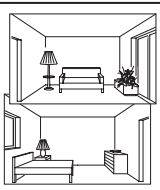





	Unidad base								
	#1	#2	#3	#4	#5	#6	#7	#8	
Dispositivo del sistema registrado									Nombre habitación
Pantalla de control									
Programador									
Sensor exterior									
Sensor de cambio calefacción/refrigeración									
Cambio ECO/Confort									
Bomba	Sí <input type="checkbox"/>	Sí <input type="checkbox"/>	Sí <input type="checkbox"/>	Sí <input type="checkbox"/>	Sí <input type="checkbox"/>	Sí <input type="checkbox"/>	Sí <input type="checkbox"/>	Sí <input type="checkbox"/>	
	No <input type="checkbox"/>	No <input type="checkbox"/>	No <input type="checkbox"/>	No <input type="checkbox"/>	No <input type="checkbox"/>	No <input type="checkbox"/>	No <input type="checkbox"/>	No <input type="checkbox"/>	
Módulo de inicio	Sí <input type="checkbox"/>	Sí <input type="checkbox"/>	Sí <input type="checkbox"/>	Sí <input type="checkbox"/>	Sí <input type="checkbox"/>	Sí <input type="checkbox"/>	Sí <input type="checkbox"/>	Sí <input type="checkbox"/>	
	No <input type="checkbox"/>	No <input type="checkbox"/>	No <input type="checkbox"/>	No <input type="checkbox"/>	No <input type="checkbox"/>	No <input type="checkbox"/>	No <input type="checkbox"/>	No <input type="checkbox"/>	

	Unidad base								
	#9	#10	#11	#12	#13	#14	U#15	#16	
Dispositivo del sistema registrado									Nombre habitación
Pantalla de control									
Bomba	Sí <input type="checkbox"/>	Sí <input type="checkbox"/>	Sí <input type="checkbox"/>	Sí <input type="checkbox"/>	Sí <input type="checkbox"/>	Sí <input type="checkbox"/>	Sí <input type="checkbox"/>	Sí <input type="checkbox"/>	
	No <input type="checkbox"/>	No <input type="checkbox"/>	No <input type="checkbox"/>	No <input type="checkbox"/>	No <input type="checkbox"/>	No <input type="checkbox"/>	No <input type="checkbox"/>	No <input type="checkbox"/>	
Módulo de inicio	Sí <input type="checkbox"/>	Sí <input type="checkbox"/>	Sí <input type="checkbox"/>	Sí <input type="checkbox"/>	Sí <input type="checkbox"/>	Sí <input type="checkbox"/>	Sí <input type="checkbox"/>	Sí <input type="checkbox"/>	
	No <input type="checkbox"/>	No <input type="checkbox"/>	No <input type="checkbox"/>	No <input type="checkbox"/>	No <input type="checkbox"/>	No <input type="checkbox"/>	No <input type="checkbox"/>	No <input type="checkbox"/>	

Unidad base 1

ES

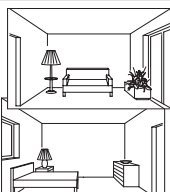
Termostato	Canal de la unidad base						Canal de módulo secundario					
	1	2	3	4	5	6	7	8	9	10	11	12
 T-149												
 T-148												
 T-146												
 T-145												
 T-144												
 T-143												
 T-141												
Sonda externa conectada												
Sonda de suelo												
Sensor exterior												
Sonda remota												
Conecte el actuador.												
												
Nombre habitación												
												



.....

.....

.....









.....

.....

.....

Unidad base 2

ES

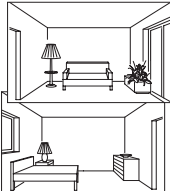
Termostato	Canal de la unidad base						Canal de módulo secundario					
	1	2	3	4	5	6	7	8	9	10	11	12
 T-149												
 T-148												
 T-146												
 T-145												
 T-144												
 T-143												
 T-141												
Sonda externa conectada												
Sonda de suelo												
Sensor exterior												
Sonda remota												
Conecte el actuador.												
												
Nombre habitación												
												



.....

.....

.....









.....

.....

.....

Unidad base 3

ES

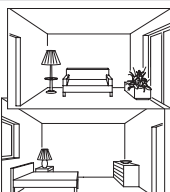
Termostato	Canal de la unidad base						Canal de módulo secundario					
	1	2	3	4	5	6	7	8	9	10	11	12
 T-149												
 T-148												
 T-146												
 T-145												
 T-144												
 T-143												
 T-141												
Sonda externa conectada												
Sonda de suelo												
Sensor exterior												
Sonda remota												
Conecte el actuador.												
												
Nombre habitación												
												



.....

.....

.....

.....









.....

.....

.....

Unidad base 4

ES

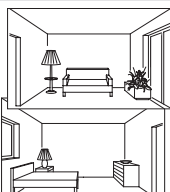
Termostato	Canal de la unidad base						Canal de módulo secundario					
	1	2	3	4	5	6	7	8	9	10	11	12
 T-149												
 T-148												
 T-146												
 T-145												
 T-144												
 T-143												
 T-141												
Sonda externa conectada												
Sonda de suelo												
Sensor exterior												
Sonda remota												
Conecte el actuador.												
												
Nombre habitación												
												



.....

.....

.....

.....

.....









.....

.....

Unidad base 5 – 16

Use esta página como plantilla para las unidades base Smatrix Base PRO 5 – 16

ES

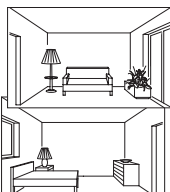
Termostato	Canal de la unidad base						Canal de módulo secundario					
	1	2	3	4	5	6	7	8	9	10	11	12
 T-149												
 T-148												
 T-146												
 T-145												
 T-144												
 T-143												
 T-141												
Sonda externa conectada												
Sonda de suelo												
Sensor exterior												
Sonda remota												
Conecte el actuador.												
												
Nombre habitación												
												



.....

.....

.....

.....

.....

.....

.....

Uponor

Uponor Hispania, S.A.U.

Avda. Leonardo da Vinci 15-17-19
Parque Empresarial La Carpetania
28906 Getafe (Madrid)

1143275 v1_11_2023_ES
Production: Uponor / ELO

Uponor se reserva el derecho a modificar sin previo aviso la gama de productos y la documentación relacionada, de conformidad con su política de mejora y desarrollo continuos.



www.uponor.com/es-es