

**Uponor**

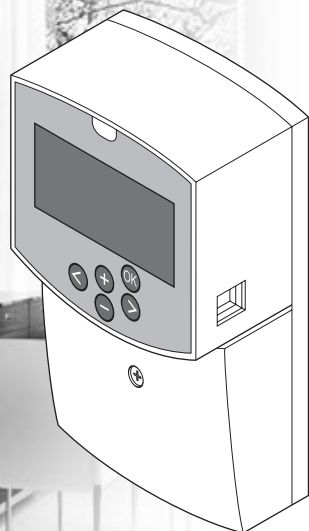

# Uponor Smatrix Move

UK INSTALLATION AND OPERATION  
MANUAL

# Table of contents

<b>1</b>	<b>Copyright and disclaimer .....</b>	<b>3</b>
<b>2</b>	<b>Preface .....</b>	<b>4</b>
2.1	Safety instructions .....	4
2.2	Limitations for radio transmission (requires antenna A-155) .....	4
2.3	Correct disposal of this product (Waste Electrical and Electronic Equipment) .....	4
<b>3</b>	<b>Uponor Smatrix Move .....</b>	<b>5</b>
3.1	System overview .....	5
3.2	Example of a system .....	5
3.3	Uponor Smatrix Move components .....	6
3.4	Accessories .....	11
3.5	Functions .....	11
<b>4</b>	<b>Install Uponor Smatrix Move .....</b>	<b>14</b>
4.1	Installation procedure .....	14
4.2	Prepare for installation .....	14
4.3	Installation examples .....	15
<b>5</b>	<b>Install Uponor Smatrix Move controller .....</b>	<b>23</b>
5.1	Placement of controller .....	23
5.2	Attach controller to the wall .....	23
5.3	Install controller antenna .....	24
5.4	Connect components to controller .....	25
5.5	Connect the controller to AC power .....	32
5.6	Connect a thermostat to the controller (requires antenna A-155) .....	32
5.7	Set system parameters .....	32
<b>6</b>	<b>Install Uponor Smatrix Wave thermostats and sensors .....</b>	<b>33</b>
6.1	Placement of thermostats .....	33
6.2	Label thermostats .....	34
6.3	Insert batteries .....	34
6.4	Connect external sensor to thermostat (optional) ..	35
6.5	Sensor input function .....	35
6.6	Attach a thermostat to the wall .....	37
6.7	Attach to table stand (T-163, T-166, and T-168 only) .....	38
6.8	First startup of digital thermostats .....	38
6.9	First setup of digital thermostat .....	40
6.10	Register a thermostat to the controller .....	41
6.11	Register a wireless outdoor sensor to the controller .....	43
6.12	Register a wired outdoor sensor .....	45
<b>7</b>	<b>Finishing installation .....</b>	<b>46</b>
7.1	Uponor Smatrix Move (wired) .....	46
7.2	Uponor Smatrix Move (wireless) .....	46
<b>8</b>	<b>Operate the Uponor Smatrix Move controller .....</b>	<b>47</b>
8.1	Principle of operation .....	47
8.2	Controller layout .....	47
8.3	Display layout .....	48
8.4	Start up .....	48
8.5	Run mode .....	49
8.6	System parameter settings .....	57
<b>9</b>	<b>Operate Uponor Smatrix Wave analogue thermostats .....</b>	<b>70</b>
9.1	Thermostat layout .....	70
9.2	Adjust temperature .....	70
9.3	Replace batteries .....	71
9.4	Factory reset .....	71
<b>10</b>	<b>Operate Uponor Smatrix Wave digital thermostats .....</b>	<b>72</b>
10.1	Thermostat layout .....	72
10.2	Display layout .....	73
10.3	Operating buttons .....	76
10.4	Start up .....	77
10.5	Adjust temperature .....	78
10.6	Run mode .....	79
10.7	Control mode .....	79
10.8	Change control mode .....	80
10.9	Settings .....	80
10.10	Replace batteries .....	86
10.11	Factory reset .....	86
<b>11</b>	<b>Maintenance .....</b>	<b>87</b>
11.1	Manual preventive maintenance .....	87
11.2	Automatic preventive maintenance .....	87
11.3	Corrective maintenance .....	87
<b>12</b>	<b>Troubleshooting .....</b>	<b>88</b>
12.1	Troubleshooting after installation .....	89
12.2	Digital thermostats T-166, T-168 and T-169, alarms/problems .....	90
12.3	Analogue thermostat T-163, alarms/problems .....	91
12.4	Controller, alarms/problems .....	91
12.5	Contact installer .....	92
12.6	Installer instructions .....	92
<b>13</b>	<b>Technical data .....</b>	<b>93</b>
13.1	Technical data .....	93
13.2	Technical specifications .....	94
13.3	Controller layout .....	95
13.4	Controller wiring diagram .....	96
13.5	Reference data for sensors .....	96
13.6	Dimensions .....	97
<b>14</b>	<b>Installation report .....</b>	<b>98</b>

# 1 Copyright and disclaimer

Uponor has prepared this installation and operation manual and all the content included solely for information purposes. The contents of the manual (including graphics, logos, icons, text, and images) are copyrighted and protected by worldwide copyright laws and treaty provisions. You agree to comply with all copyright laws worldwide in your use of the manual. Modification or use of any of the contents of the manual for any other purpose is a violation of Uponor's copyright, trademark and other proprietary rights.

The presumption for the manual is that the safety measures have been fully complied with and, further, that Uponor Smatrix Move, including any components that are part of such system, covered by the manual:

- is selected, planned and installed and put into operation by a licensed and competent planner and installer in compliance with current (at the time of installation) installation instructions provided by Uponor as well as in compliance with all applicable building and plumbing codes and other requirements and guidelines;
- has not been (temporarily or continuously) exposed to temperatures, pressure and/or voltages that exceed the limits printed on the products or stated in any instructions supplied by Uponor;
- remain in its originally installed location and is not repaired, replaced or interfered with, without prior written consent of Uponor;
- is connected to potable water supplies or compatible plumbing, heating and/or cooling products approved or specified by Uponor;
- is not connected to or used with non-Uponor products, parts or components except for those approved or specified by Uponor; and
- does not show evidence of tampering, mishandling, insufficient maintenance, improper storage, neglect or accidental damage before installation and being put into operation.

While Uponor has made efforts to ensure that the manual is accurate, Uponor does not guarantee or warrant the accuracy of the information contained herein. Uponor reserves the right to modify the specifications and features described herein, or discontinue manufacture of Uponor Smatrix Move described at any time without prior notice or obligation. The manual is provided "as is" without warranties of any kind, either expressed or implied. The information should be independently verified before using it in any manner.

**To the fullest extent permissible, Uponor disclaims all warranties, expressed or implied, including, but not limited to, the implied warranties of merchantability, fitness for particular purpose and non-infringement.**

This disclaimer applies to, but is not limited to, the accuracy, reliability or correctness of the manual.

**Under no circumstances shall Uponor be liable for any indirect, special, incidental or consequential damages or loss that result from the use of or the inability to use the materials or information in the manual, or any claim attributable to errors, omission or other inaccuracies in the manual, even if Uponor has been advised of the possibility of such damages.**

**This disclaimer and any provisions in the manual do not limit any statutory rights of consumers.**

## 2 Preface

This installation and operation manual describes how to install and operate the components of the system.

### 2.1 Safety instructions

#### Warnings used in this manual

The following symbols are used in the manual to indicate special precautions when installing and operating any Uponor equipment:



#### **WARNING!**

Risk of injury. Ignoring warnings can cause injury or damage components.



#### **CAUTION!**

Ignoring cautions can cause malfunctions.

#### Safety measures

Conform to the following measures when installing and operating any Uponor equipment:

- Read and follow the instructions in the installation and operation manual.
- Installation must be performed by a competent person in accordance with local regulations.
- It is prohibited to make changes or modifications not specified in this manual.
- All power supplies must be switched off before starting any wiring work.
- Do not use water to clean Uponor components.
- Do not expose the Uponor components to flammable vapours or gases.

Uponor cannot accept any responsibility for damage or breakdown that can result from ignoring these instructions.

#### Power



#### **WARNING!**

The Uponor system uses 230 V AC, 50 Hz power. In case of emergency, immediately disconnect the power.

#### Technical constraints



#### **CAUTION!**

To avoid interference, keep installation/data cables away from power cables of more than 50 V.

### 2.2 Limitations for radio transmission (requires antenna A-155)

The Uponor system uses radio transmission. The frequency used is reserved for similar applications, and the chances of interference from other radio sources are very low.

However, in some rare cases, it might not be possible to establish perfect radio communication. The transmission range is sufficient for most applications, but each building has different obstacles affecting radio communication and maximum transmission distance. If communication difficulties exist, Uponor recommends relocating the antenna to a more optimal position, and not installing Uponor radio sources too close to each other (**at least 40 cm apart**), for solving exceptional problems.

### 2.3 Correct disposal of this product (Waste Electrical and Electronic Equipment)



#### **NOTE!**

Applicable in the European Union and other European countries with separate collection systems



This marking shown on the product or its literature indicates that it should not be disposed with other household waste at the end of its working life. To prevent possible harm to the environment or human health from uncontrolled waste disposal, please separate this from other types of wastes and recycle it responsibly to promote the sustainable reuse of material resources.

Household users should contact either the retailer where they purchased this product, or their local government office, for details of where and how they can take this item for environmentally safe recycling.

Business users should contact their supplier and check the terms and conditions of the purchase contract. This product should not be mixed with other commercial wastes of disposal.



## 3 Uponor Smatrix Move

Uponor Smatrix Move is a primary temperature control system for heating and cooling installations utilising underfloor heating, radiators, floor cooling etc. Comfort, user friendliness and temperature control for a home can be combined through the various components.

Example: The Move controller together with an external antenna and wireless thermostat, adds versatility, reduces system response times, and enables integration with an Uponor Smatrix Wave system.

### 3.1 System overview

#### UPONOR SMATRIX MOVE

Uponor Smatrix Move is used to control a heating system. It consists of a controller, a wired outdoor sensor, and a supply/return sensor. The controller manages the supply water temperature through control of the mixer valve actuator. Optionally, a circulation pump can also be controlled.

With an external antenna Uponor Smatrix Move can use different types of thermostats to regulate heating and cooling in the system. Designed for maximum comfort, the thermostats communicate with the controller by radio link. It is possible to mix a maximum of two different types of Uponor Smatrix Wave thermostats in the same installation. One of these thermostats though can only function as a wireless connection point for the outdoor temperature sensor.

### 3.2 Example of a system

#### UPONOR SMATRIX MOVE (WIRED)

The illustration below shows Uponor Smatrix Move with several installation options.

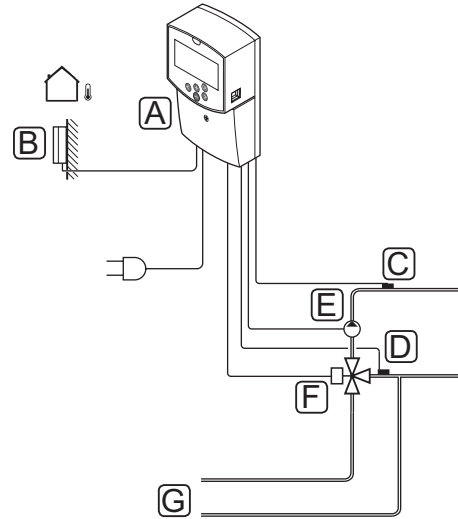

Item	Description
A	Uponor Smatrix Move X-157 (controller X-157)
B	Uponor Smatrix S-1XX (outdoor sensor S-1XX)
C	Uponor Smatrix Move S-152 (return sensor S-152)
D	Uponor Smatrix Move S-152 (supply sensor S-152)
E	Circulation pump
F	Mixer valve
G	Pipes to/from heating source

### UPONOR SMATRIX MOVE (WIRELESS)

The illustration below shows Uponor Smatrix Move with several installation options and a wireless thermostat.

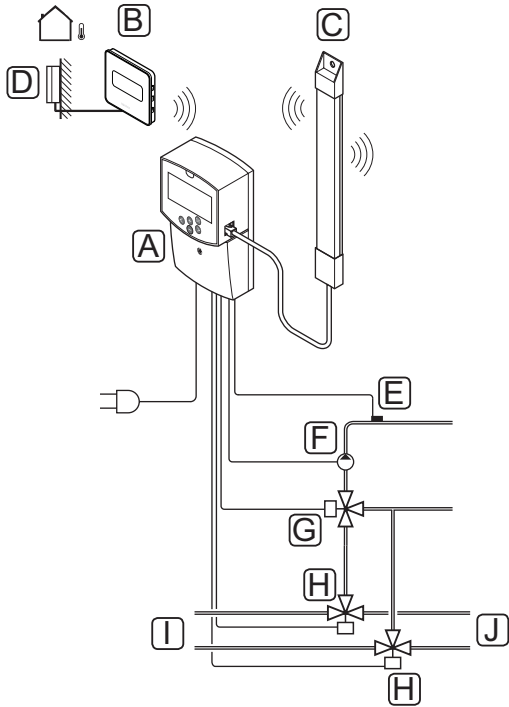

Item	Description
A	Uponor Smatrix Move X-157 (controller X-157)
B	Uponor Smatrix Wave T-169 (digital thermostat with RH T-169)
C	Uponor Smatrix Move A-155 (antenna)
D	Uponor Smatrix S-1XX (outdoor sensor S-1XX)
E	Uponor Smatrix Move S-152 (supply sensor S-152)
F	Circulation pump
G	Mixer valve
H	3-way switchover valve, optional for heating/cooling installations
I	Pipes to/from heating source
J	Pipes to/from cooling source

### 3.3 Uponor Smatrix Move components

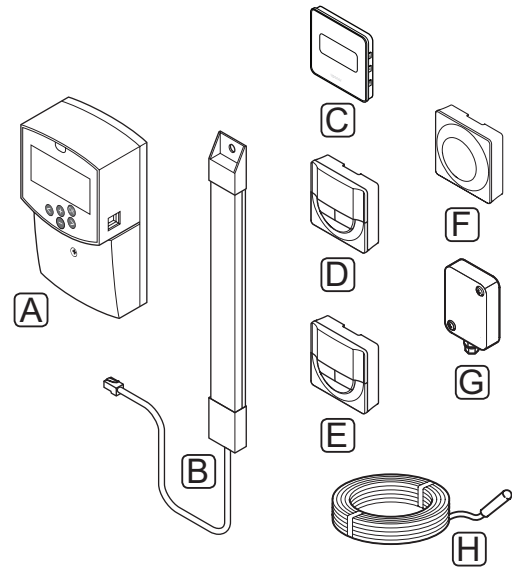

Pos.	Uponor designation	Description
A	Uponor Smatrix Move X-157	Controller
B	Uponor Smatrix Move A-155	Antenna
C	Uponor Smatrix Wave T-169 (digital thermostat with RH T-169)	Digital thermostat with relative humidity sensor and operative sensor
D	Uponor Smatrix Wave T-168 (programmable thermostat with RH T-168)	Programmable digital thermostat with relative humidity sensor
E	Uponor Smatrix Wave T-166 (digital thermostat T-166)	Digital thermostat
F	Uponor Smatrix Wave T-163 (public thermostat T-163)	Public thermostat
G	Uponor Smatrix S-1XX	Outdoor temperature sensor
H	Uponor Smatrix Move S-152	Supply or return temperature sensor

## CONTROLLER

The controller operates the 3-way valve actuator and circulation pump, which in turn affect the flow of the supply water, to change both the supply and indoor temperatures.



### CAUTION!

Only 230 V valve actuators are compatible with the controller.

## Uponor Smatrix Move X-157

The Uponor Smatrix Move X-157 is a controller which uses an outdoor temperature sensor, a supply temperature sensor, an optional return temperature sensor, and system parameters to regulate the system.

Main characteristics:

- Control of supply temperature to heating and/or cooling systems.
- Heating and cooling curve for outdoor compensation.
- 3-way valve control with status in display.
- 2-way valve control, special actuator, with status in display.
- Heating/cooling outputs for switchover valves.
- Circulation pump control with status in display.
- Scheduling, pre-programmed and customizable schedules.
- Outdoor temperature sensor, wired.
- Start/stop of heating source (boiler etc) and/or cooling source (chiller etc).
- Lower indoor temperature with night set back (ECO mode).

Options:

- Wall mounted (screws supplied).
- External antenna, which must be installed vertically.

The antenna and a wireless room thermostat adds support for:

- 1-way communication with a room thermostat (receive information from the thermostat).
- Control of supply temperature to cooling systems with relative humidity control.
- Outdoor temperature sensor, wireless (via a thermostat).
- System integration with an Uponor Smatrix Wave system.

## Components of the controller

The illustration below shows the controller and its components.

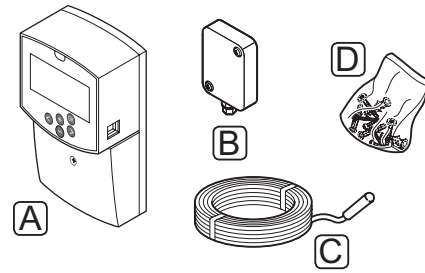





Item	Description
A	Uponor Smatrix Move X-157
B	Uponor Smatrix S-1XX
C	Uponor Smatrix Move S-152
D	Mounting material

### THERMOSTATS (REQUIRES ANTENNA A-155)

The thermostats communicate with the Move controller through radio transmissions (requires antenna A-155). It is possible to mix a maximum of two different types of Uponor Smatrix Wave thermostats in the same installation. One of these thermostats though can only function as a wireless connection point for the outdoor temperature sensor.

The following Uponor Smatrix thermostats can be used in the system:

	Uponor Smatrix Wave T-169 (digital thermostat with RH T-169)
	Uponor Smatrix Wave T-168 (programmable thermostat with RH T-168)
	Uponor Smatrix Wave T-166 (digital thermostat T-166)
	Uponor Smatrix Wave T-163 (public thermostat T-163)



#### CAUTION!

Do not attempt to connect Uponor Smatrix Base thermostats to the controller. They are not suited for each other, and they may get damaged.



#### CAUTION!

Antenna A-155 must be installed when using a wireless thermostat.



#### NOTE!

The thermostat is affected by the temperature of the surrounding surfaces as well as the ambient air temperature.

### Uponor Smatrix Wave T-169

The thermostat shows the ambient, set temperature or relative humidity on the display. Temperature settings are adjusted using the +/- buttons on the front.

Main characteristics:

- Power saving e-paper display (updates every 10 minutes).
- Displays Celsius or Fahrenheit.
- Operative sensor for increased comfort.
- Calibration of displayed room temperature.
- Heating/cooling demand as well as low battery indication on display.
- Displays Uponor logo and software version during power up sequence.
- Setpoint range is 5 – 35 °C (maximum and minimum setting may be limited by other system settings).
- Room temperature regulation with use of optional external temperature sensors.
- Displays optional temperature sensor values if sensors are connected and relevant room temperature regulation is activated.
- Relative humidity limit indicated in display.
- Invert display color.
- Can be placed up to 30 meters away from the controller.

Components of the thermostat:

The illustration below shows the thermostat and its components.

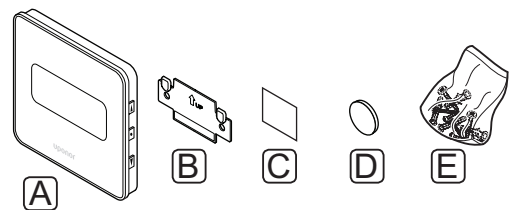

Item	Description
A	Uponor Smatrix Wave T-169
B	Wall bracket
C	Adhesive tape
D	Battery (CR2032 3V)
E	Mounting material

## Uponor Smatrix Wave T-168

The programmable thermostat shows the ambient, set temperature or relative humidity, and time on the display. Settings are adjusted using the +/- buttons on the front. Other programmable settings are scheduling and individual night set back (on a room by room basis) etc.

Main characteristics:

- Backlit display, dims after 10 seconds of inactivity.
- Displays Celsius or Fahrenheit.
- Calibration of displayed room temperature.
- Heating/cooling demand as well as low battery indication on display.
- Displays software version during power up sequence.
- Setup wizard to set time and date when installed for the first time or after a factory reset.
- 12/24h clock for scheduling.
- Setpoint range is 5 – 35 °C (maximum and minimum setting may be limited by other system settings).
- Room temperature regulation with use of optional external temperature sensors.
- Displays optional temperature sensor values if sensors are connected and relevant room temperature regulation is activated.
- Programmable to switch between Comfort and ECO modes and adjustable ECO setback value. If an external timer is available it can be used instead to switch between Comfort and ECO.
- Relative humidity limit indicated in display (requires integration with a Wave system).
- Scheduling, pre-programmed and customizable schedules.
- Lower indoor temperature on a room by room basis with night set back.
- Can be placed up to 30 meters away from the controller.

Components of the thermostat:

The illustration below shows the thermostat and its components.

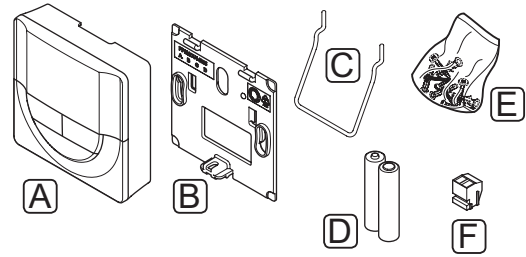

Item	Description
A	Uponor Smatrix Wave T-168
B	Wall bracket
C	Stand
D	Batteries (AAA 1.5 V)
E	Mounting material
F	Connection terminal

### Uponor Smatrix Wave T-166

The thermostat shows the ambient or set temperature on the display. Temperature settings are adjusted using the +/- buttons on the front.

Main characteristics:

- Backlit display, dims after 10 seconds of inactivity.
- Displays Celsius or Fahrenheit.
- Calibration of displayed room temperature.
- Heating/cooling demand as well as low battery indication on display.
- Displays software version during power up sequence.
- Setpoint range is 5 – 35 °C (maximum and minimum setting may be limited by other system settings).
- Room temperature regulation with use of optional external temperature sensors.
- Displays optional temperature sensor values if sensors are connected and relevant room temperature regulation is activated.
- Can be placed up to 30 meters away from the controller.

Components of the thermostat:

The illustration below shows the thermostat and its components.

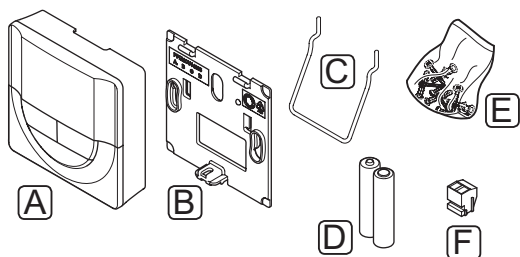

Item	Description
A	Uponor Smatrix Wave T-166
B	Wall bracket
C	Stand
D	Batteries (AAA 1.5 V)
E	Mounting material
F	Connection terminal

### Uponor Smatrix Wave T-163

The thermostat is designed for public locations, which means that the dial is hidden. It must be removed from the wall to set the temperature.

Main characteristics:

- Adjust setpoint temperature with a potentiometer on the back of the thermostat.
- Setpoint range is 5 – 35 °C (maximum and minimum setting may be limited by other system settings).
- Optional external temperature sensor can be connected to the thermostat.
- DIP switch for selecting between function or sensor mode of operation.
- Enable or disable Comfort/ECO scheduling for the zone with a DIP switch on the back.
- Can be placed up to 30 meters away from the controller.

Components of the thermostat:

The illustration below shows the thermostat and its components.

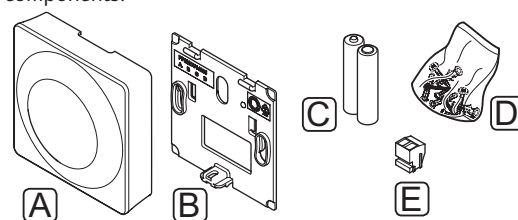

Item	Description
A	Uponor Smatrix Wave T-163
B	Wall bracket
C	Batteries (AAA 1.5 V)
D	Mounting material
E	Connection terminal

### 3.4 Accessories

Uponor offers a wide variety of accessories for use with the standard portfolio.

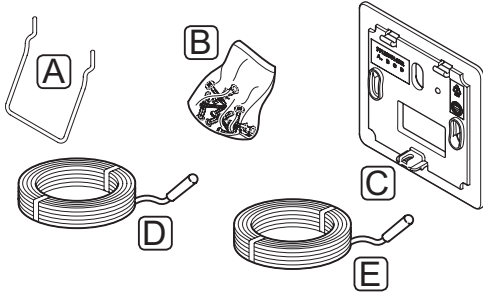

#### NOTE!

Some of these accessories may also be included in the system.

Item	Component	Description
A	Attachment options for thermostats T-163, T-166, T-168	Table stand
B	Screws	Screws
C	Uponor Smatrix Wallframe T-X A-1XX (wallframe T-X A-1XX)	Wall frame for covering larger area of the wall than original back plate. Used at installation of thermostats T-163, T-166, T-168
D	Uponor Smatrix Move Sensor Supply/Return S-152	Supply/return sensor for use with the controller
E	Uponor Smatrix Sensor Floor/Remote S-1XX (floor/remote sensor S-1XX)	Floor/remote sensor for use with thermostats T-163, T-166, T-168 and T-169

### 3.5 Functions

Uponor Smatrix Move is used to control an underfloor heating and/or cooling system in a house.

The controller calculates the supply temperature using the outdoor temperature and a heating curve. The calculated supply temperature is compared to the measured supply temperature. If the measured temperature differs from the calculated, the controller adjusts the flow through the mixer valve to raise or lower the supply temperature.

If a thermostat is present in the system (requires antenna A-155), it is also used to further adjust the flow to the reference room and to reach the setpoint quicker.

As soon as the temperature measured at the thermostat is lower (heating mode) or higher (cooling mode) than the setpoint temperature, a demand to change the room temperature is created and sent to the controller. The controller will open the actuator according to current operating mode and other settings. Once the set temperature is reached, the actuator closes.

## HEATING AND COOLING CURVE

The heating and cooling curves for the Uponor Smatrix Move controller is shown in the diagram below. The diagram shows the calculated supply temperature, for each curve, at different outdoor temperatures. The controller uses the selected curve to operate the mixer valve, which in turn adjusts the supply temperature to the system.

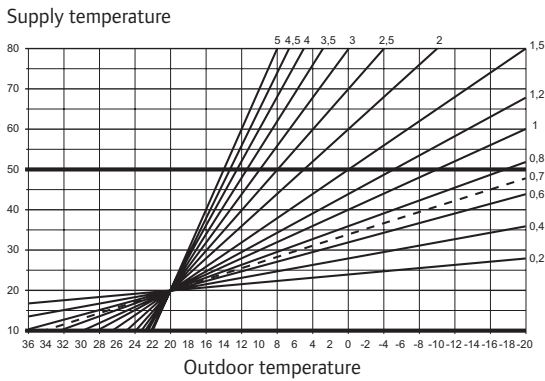

The choice of curve depends on a combination of different factors, such as how well insulated the house is, geographical location, type of heating/cooling system etc.

Example:

A poorly insulated house heated by a radiator system requires a higher curve value than an equivalent house with underfloor heating.

The curves in the diagram are also limited by maximum and minimum parameters set in the system (marked in the diagram with extra thick lines).

## COMFORT AND ECO MODES

With the integrated timer in the controller, it is possible to regulate the temperature setpoint modes between two different temperatures. Available modes are **Comfort**, **ECO** (economy), and **Holiday** (controller only). See *example of Comfort and ECO mode below*.

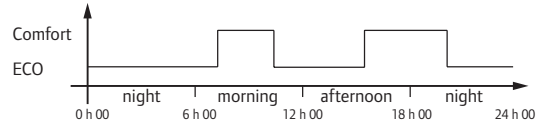

The diagram shows that the system delivers heating in Comfort mode in the morning and afternoon, but the system enters ECO mode during night and in the middle of the day, when the house normally is empty.

## HEATING/COOLING OFFSET

Uponor uses an Offset temperature to adjust the setpoints when switching between heating and cooling. This improves the performance of the system and reduces the need of manual setpoint adjustments when switching between heating and cooling.

The default value is set to 2 °C and is used to increase the setpoint when switching to cooling. When switching back to heating, the setpoint is reduced.



**RELATIVE HUMIDITY FUNCTION (MOVE INTEGRATED WITH OTHER SYSTEM ONLY, REQUIRES ANTENNA A-155)**

To avoid condensation when having a cooling system, it is recommended measuring the relative humidity (RH) in a reference room. The relative humidity is measured with a thermostat with a RH sensor.

The thermostat sends the current RH value to a controller (Wave with interface I-167) integrated to the Move system. The value is compared to set RH limits and adjusts operational parameters accordingly.

If the RH value is below the limit, operation continues as normal.

If the value is above the set limit, information is sent to the thermostat and an icon is lit indicating too high RH. The thermostat then forwards the information to the Move controller through the integration link.

When the Move controller receives information about too high RH, an icon is lit in its display and starts raising the setpoint 0.1 °C per minute. The controller keeps raising the setpoint until the RH value falls below a set limit in the integrated controller. The RH indication icons are turned off and the Move controller starts lowering the setpoint 0.1 °C per minute until either the setpoint is back to normal again or until RH value is above the limit again.

*See separate documentation for the Wave system to get their RH limits.*

**REAL TIME CLOCK**

To facilitate accurate scheduling and different timer settings, the controller contains a real time clock.

**SYSTEM INTEGRATION WITH WAVE SYSTEMS (REQUIRES ANTENNA A-155 AND A WIRELESS THERMOSTAT)**

The system can share thermostat temperature data and system modes, such as Comfort/ECO and heating/cooling, with an Uponor Smatrix Wave system.

The integration is activated when the thermostat is registered to both controllers (Move with antenna A-155 and Wave).

*See separate documentation on how to register the thermostat to a Wave system.*

## 4 Install Uponor Smatrix Move

### 4.1 Installation procedure

#### UPONOR SMATRIX MOVE

Uponor recommends following the process described below to guarantee the best possible installation results.

Stage	Procedure	Page
1	Prepare for installation	14
2	Install Uponor Smatrix Move controller	23
3	Install Uponor Smatrix Wave thermostats and sensors	33
4	Finishing installation	46

### 4.2 Prepare for installation

Before starting the installation:

- Verify the contents of the package with the packing list.  
*See also section 3.3 Uponor Smatrix Move components for identification of components.*
- Check whether an external temperature sensor is to be installed with a compatible thermostat (requires antenna A-155).
- Study the wiring diagram in the end of this manual.

To determine where to best place the Uponor Smatrix Move components, follow these guidelines:

- Ensure that the controller can be installed close to the mixing valve actuator or pump.
- Ensure that the controller can be mounted close to a 230 V AC wall socket, or if required by local regulations to a junction box, connected to the mains power.
- Ensure that installed components are protected from running or dripping water.
- We recommend that the Uponor Smatrix Move antenna is mounted in vertical position.

### 4.3 Installation examples

The following sections describe a few installation examples:

- Basic heating system, with Uponor Smatrix Move
- Heating and cooling system, with Uponor Smatrix Move
- Heating system together with DHWT and panel heater, with Uponor Smatrix Move
- Uponor Smatrix Move integrated with an Uponor Smatrix Wave system
- Free cooling together with a heat pump in a combined heating/cooling system



#### WARNING!

There is 230 V (5 A) power in the controller when connected to the mains.



#### WARNING!

Electrical installation and service behind secured 230 V AC covers must be carried out under the supervision of a qualified electrician.



#### CAUTION!

Do not attempt to connect Uponor Smatrix Base thermostats to the controller. They are not suited for each other, and they may get damaged.



#### NOTE!

These are outline diagrams. Real systems must be installed according to applicable norms and regulations.



#### NOTE!

Only 230 V Uponor actuators are compatible with the controller.



#### NOTE!

When registering a thermostat to the controller (requires antenna A-155), run mode changes parameter **0 (type)** to **rEv**, regardless of previous setting. Heating/cooling is then controlled by the thermostat, or the integrated system.



#### NOTE!

If the outdoor sensor is placed too far away from the reference room (requires antenna A-155), a separate thermostat can be used to register the outdoor sensor.

### SYSTEM DESCRIPTION

The controller calculates the supply temperature using the outdoor temperature and a heating curve. The calculated supply temperature is compared to the measured supply temperature. If the measured temperature differs from the calculated, the controller adjusts the flow through the mixer valve to raise or lower the supply temperature.

#### Outdoor temperature sensor

The outdoor temperature is obtained from an outdoor temperature sensor, which is wired to the controller or a wireless thermostat (requires antenna A-155).

#### Optional return sensor

In systems without a wireless thermostat, an optional return temperature sensor can be connected. The return sensor is used to speed up the reaction of the system using a boost parameter. The boost parameter to adjust the calculated supply temperature, if the difference between supply and return temperatures is too large.

#### Wireless thermostat (requires antenna A-155)

A wireless thermostat (placed in a reference room), adds versatility, quickens the system, and enables integration with an Uponor Smatrix Wave system.

As soon as the temperature measured at the thermostat is lower (heating mode) or higher (cooling mode) than the setpoint temperature, a demand to change the room temperature is created and sent to the controller. The controller will open the actuator according to current operating mode and other settings. Once the set temperature is reached, this information is sent and the actuator is closed.

*See section 6.10 Register thermostats to the controller for more information about registering a thermostat to the Move controller.*

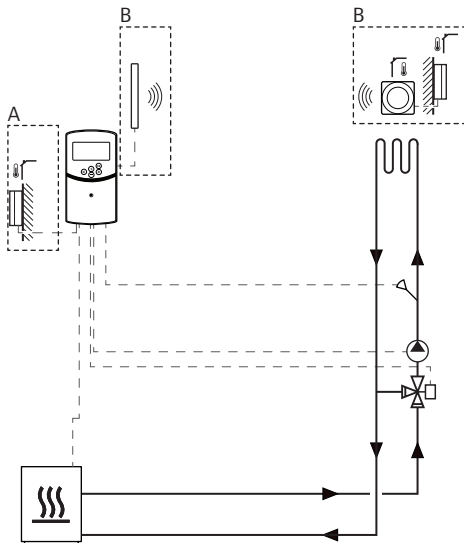
**BASIC HEATING SYSTEM**

A = Wired, B = Wireless

**WARNING!**

There is 230 V (5 A) power in the controller when connected to the mains.

**NOTE!**

This is an outline diagram. A real system must be installed according to applicable norms and regulations.

**NOTE!**

When registering a thermostat to the controller (requires antenna A-155), run mode changes parameter **0 (type)** to **rEv**, regardless of previous setting. Heating/cooling is then controlled by the thermostat, or the integrated system.

**NOTE!**

If the outdoor sensor is placed too far away from the reference room (requires antenna A-155), a separate thermostat can be used to register the outdoor sensor.

This installation example depicts a basic heating system.

The circulation pump and mixer valve is operated by the controller to maintain the supply temperature.

**Example specific electrical connections**

- The circulation pump is connected to the terminal labelled **P1**.
- The mixer valve actuator is connected to the terminal labelled **ACTUATOR**.

See section 5.4 *Connect components to controller for more information*.

See also the wiring diagram in the end of the manual.

**Example specific system parameter settings**

- Set parameter 0 – Type of installation to **Hot** if it is a heating system.

See section 8.6 *System parameter settings for more information*.

## HEATING AND COOLING SYSTEM

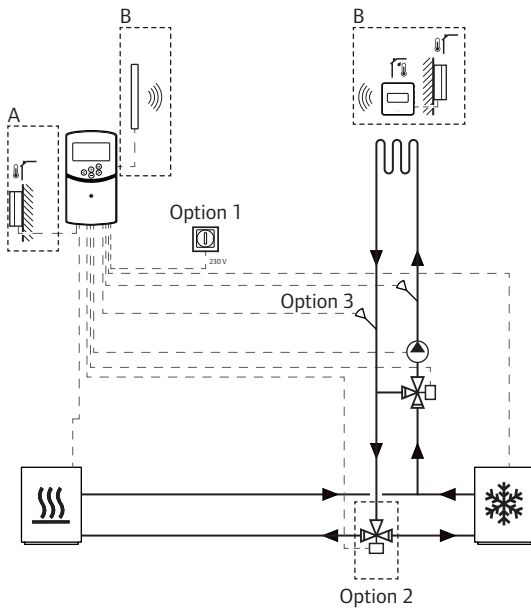

A = Wired, B = Wireless



### WARNING!

There is 230 V (5 A) power in the controller when connected to the mains.



### NOTE!

This is an outline diagram. A real system must be installed according to applicable norms and regulations.



### NOTE!

If the outdoor sensor is placed to far away from the reference room (requires antenna A-155), a separate thermostat can be used to register the outdoor sensor.



### NOTE!

When registering a thermostat to the controller (requires antenna A-155), run mode changes parameter **0 (type)** to **rEv**, regardless of previous setting. Heating/cooling is then controlled by the thermostat, or the integrated system.

This installation example depicts a heating and cooling system.

The circulation pump and mixer valve is operated by the controller to maintain the supply temperature.

The controller switches between heating and cooling using either a physical heating/cooling switch (option 1) connected to the controller, or via a digital thermostat (requires antenna A-155). These options cannot be combined in a Move system with a wireless thermostat, since the **HC** option in parameter 11, or 12, is disabled when a digital thermostat is registered to the controller.

An optional switchover valve (option 2) can be used to divert the supply between the heating and cooling sources.

An optional return temperature sensor (option 3), is in a Move system connected the controller to speed up the reaction of the system. This is achieved using a boost parameter to adjust the calculated supply temperature, if the difference between supply and return temperatures is to large.

### Example specific electrical connections

- The circulation pump is connected to the terminal labelled **P1**.
- The mixer valve actuator is connected to the terminal labelled **ACTUATOR**.
- The optional switchover valve actuator is connected to the terminal labelled **P2/COLD**.
- The optional heating/cooling switch is connected to the terminal labelled **ROOMSTAT** (terminal **In1** or **In2**).
- The optional return temperature sensor is connected to the terminal labelled **WATER RETURN**.

See section 5.4 Connect components to controller for more information.

See also the wiring diagram in the end of the manual.

### Example specific system parameter settings

- Set parameter 0 – Type of installation to **rEv** if it is a heating/cooling system.
- Set parameter 4 – Type of system to **Act** if the optional switchover valve is installed.
- Set parameter 4 – Type of system to **SEP** if the optional switchover valve is not installed.
- Set parameter 5 – Thermostat selection to **no** (to utilise the boost function) The boost function can only be used in systems with a return sensor, and without a wireless thermostat).
- Set parameter 7 – Boost function to an appropriate value, for the system (requires parameter 5 being set to no and is used in systems with a return sensor, and without a wireless thermostat).
- Set parameter 11/12 – Wired input 1/2 selection to **HC** if a heating/cooling switch (option 1) is connected to the controller.

See section 8.6 System parameter settings for more information.

See section 6.10 Register thermostats to the controller for more information about registering a thermostat to the Move controller.

### HEATING SYSTEM TOGETHER WITH DHWT AND PANEL HEATER

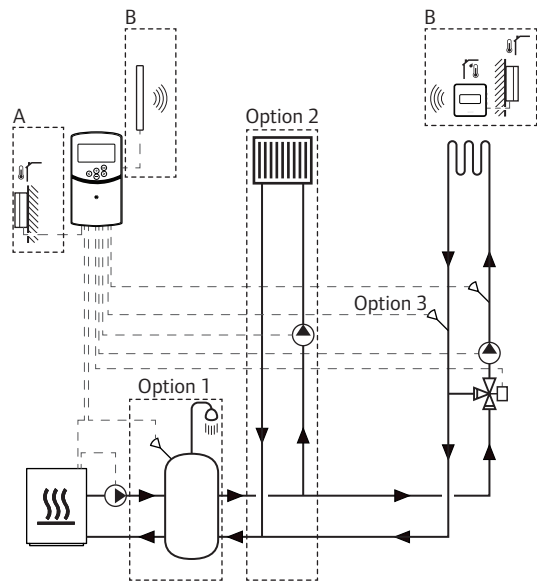

A = Wired, B = Wireless



#### WARNING!

There is 230 V (5 A) power in the controller when connected to the mains.



#### NOTE!

This is an outline diagram. A real system must be installed according to applicable norms and regulations.



#### NOTE!

If the outdoor sensor is placed too far away from the reference room (requires antenna A-155), a separate thermostat can be used to register the outdoor sensor.



#### NOTE!

When registering a thermostat to the controller (requires antenna A-155), run mode changes parameter **0 (type)** to **rEv**, regardless of previous setting. Heating/cooling is then controlled by the thermostat, or the integrated system.

This installation example depicts a heating system with an optional domestic hot water tank (DHWT) and panel heater. The system prioritises domestic hot water.

The circulation pump and mixer valve, supplying the heating system, is operated by the controller to maintain the supply temperature.

An optional DHWT (option 1) is installed close to the heat source, with an immersion thermostat/aquastat connected to the controller.

An optional panel heater (option 2) is installed before the mixer valve to offer an extra heating system, using the full capabilities of the heat source. The operation of the second circulation pump, supplying the panel heater, can be controlled by an optional extra wireless thermostat (requires antenna A-155).

An optional return temperature sensor (option 3), is in a Move system (without a wireless thermostat) connected to the controller to speed up the reaction of the system. This is achieved using a boost parameter to adjust the calculated supply temperature, if the difference between supply and return temperatures is too large.

#### Example specific electrical connections

- The circulation pump, supplying the heating system, is connected to the terminal labelled **P1**.
- The circulation pump, supplying the optional panel heater, is connected to the terminal labelled **P2/ COLD**.
- The mixer valve actuator, supplying the heating system, is connected to the terminal labelled **ACTUATOR**.
- The immersion thermostat/aquastat is connected to the terminal labelled **ROOMSTAT** (terminal **In1** or **In2**).
- The optional return temperature sensor is connected to the terminal labelled **WATER RETURN**.

See section 5.4 Connect components to controller for more information.

See also the wiring diagram in the end of the manual.

#### Example specific system parameter settings

- Set parameter 0 – Type of installation to **Hot** if it is a heating system.
- Set parameter 4 – Type of system to **2P.1** if the circulation pump supplying the optional panel heater is installed.
- Set parameter 5 – Thermostat selection to **no** (to utilise the boost function) The boost function can only be used in systems with a return sensor, and without a wireless thermostat).
- Set parameter 7 – Boost function to an appropriate value, for the system (requires parameter 5 being set to no and is used in systems with a return sensor, and without a wireless thermostat).
- Set parameter 11/12 – Wired input 1/2 selection to **Aqu** if an immersion thermostat/aquastat is installed in the tank, and connected to the controller.

See section 8.6 System parameter settings for more information.

See section 6.10 Register thermostats to the controller for more information about registering a thermostat to the Move controller.

**UPONOR SMATRIX MOVE INTEGRATED  
WITH AN UPONOR SMATRIX WAVE SYSTEM  
(REQUIRES ANTENNA A-155)**

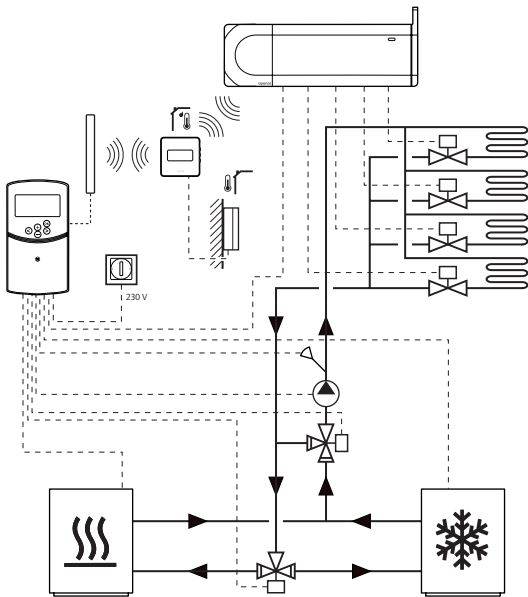

**WARNING!**

There is 230 V (5 A) power in the controller when connected to the mains.



**CAUTION!**

Antenna A-155 must be installed when using a wireless thermostat.



**NOTE!**

This is an outline diagram. A real system must be installed according to applicable norms and regulations.



**NOTE!**

If the outdoor sensor is placed too far away from the reference room (requires antenna A-155), a separate thermostat can be used to register the outdoor sensor.



**NOTE!**

When registering a thermostat to the controller (requires antenna A-155), run mode changes parameter **0 (type)** to **rEv**, regardless of previous setting. Heating/cooling is then controlled by the thermostat, or the integrated system.

With a registered wireless thermostat (requires antenna A-155), the Uponor Smatrix Move controller can be integrated with an Uponor Smatrix Wave system to enhance the capabilities of a full climate system. At the same time, the integration removes the need of a separate thermostat, and outdoor sensor, for the Move system.

**Shared information**

Information regarding system state and reference room temperature is forwarded to the Move controller, which adjusts the supply temperature accordingly.

Different system states and temperatures which can be forwarded are:

- Comfort/ECO mode\*
- Heating/cooling mode
- Holiday mode\*
- Reference room temperature and setpoint
- Outdoor temperature (if installed in the thermostat)
- Remote sensor (if installed in the thermostat)
- Indication if the relative humidity exceeds set limits (requires the digital thermostat T-168 or T-169, and interface I-167)

\* ) *Through change of setpoint, using the ECO setback value from the integrated system. No indication or change of mode is shown in the Move controller.*

See section 6.10 Register a thermostat to the controller for more information.

**Circulation pump**

In this example, a circulation pump demand signal is sent from Wave to Move, through a connected cable.

The PUMP terminal, in the Wave controller, is connected to the wired input (In1 or In2) in the Move controller.

See section 5.4 Connect components to controller > Connect circulation pump demand signal to controller for more information.

See the Uponor Smatrix Wave documentation for more information.



### FREE COOLING TOGETHER WITH A HEAT PUMP IN A COMBINED HEATING/COOLING SYSTEM

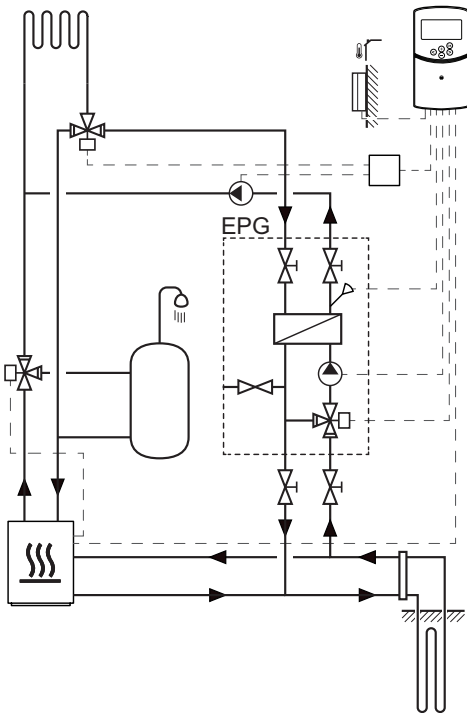

#### WARNING!

There is 230 V (5 A) power in the controller when connected to the mains.



#### NOTE!

This is an outline diagram. A real system must be installed according to applicable norms and regulations.

This installation example depicts a combined heating/cooling system where a heat pump produces heating and hot water, and an Uponor pump group (EPG) supplies the system with free cooling. For best performance, upgrade the Move system with the antenna A-155 and a wireless thermostat.

The pump group (EPG) consists of a brine circulation pump, a 3-way valve with an actuator, temperature gauges, closing valves, and a heat exchanger. The EPG is controlled by an integrated Uponor Smatrix Move controller.

The integrated Move controller also controls the external circulation pump supplying the heating/cooling system with free cooling and a 3-way valve, for switching between heating and cooling.

The heat pump has internal circulation pumps for heating, hot water and brine.

When a cooling demand emerge, the heat pump sends (or another device, such as a switch) a signal to the EPG. The integrated Move controller switches over the 3-way valves and starts the circulation pumps to start producing free cooling. When the system is in cooling mode, the heat pump also can produce domestic hot water.

### Example specific electrical connections

- The EPG brine circulation pump, is connected to the terminal labelled **P1**.
- The EPG supply temperature sensor, is connected to the terminal labelled **WATER IN**.
- The EPG 3-way valve actuator, is connected to the terminal labelled **ACTUATOR**.
- The external cooling circulation pump, supplying the heating/cooling system, is connected to a junction box, in turn connected the terminal labelled **P2/COLD**.
- The external 3-way valve actuator, switching the system between heating and cooling, is connected to a junction box, in turn connected the terminal labelled **P2/COLD**.
- The heat pump heating/cooling signal is connected to the terminal labelled **ROOMSTAT** (terminal **In1** or **In2**).

See section 5.4 Connect components to controller for more information.

See also the wiring diagram in the end of the manual.

### Example specific system parameter settings

- Set parameter 0 – Type of installation to **rEv** if it is a heating/cooling system.
- Set parameter 2 – Maximum supply temperature (heating) to **11 °C** to avoid the cooling from interfering with the primary heat production.
- Set parameter 3 – Minimum supply temperature (heating) to **5 °C** to avoid the cooling from interfering with the primary heat production.
- Set parameter 4 – Type of system to **Act** if the external 3-way valve and circulation pump is installed.
- Set parameter 5 – Thermostat selection to **no** (to utilise the boost function) The boost function can only be used in systems with a return sensor, and without a wireless thermostat).
- Set parameter 7 – Boost function to an appropriate value, for the system (requires parameter 5 being set to no and is used in systems with a return sensor, and without a wireless thermostat).
- Set parameter 11/12 – Wired input 1/2 selection to **HC** if a heat pump heating/cooling signal is connected to the controller.

See section 8.6 System parameter settings for more information.

## 5 Install Uponor Smatrix Move controller

### 5.1 Placement of controller

Refer to the installation preparation guidelines (see section 4.2 *Prepare for installation*), and use the following guidelines when positioning the controller:

- Position the controller close to the actuator, if possible. Check the position of the 230 V AC wall socket, or if required by local regulations, a junction box, connected to the mains power.
- Check that the cover of the controller can be removed easily.
- Check that connectors and switches are easily accessible.



#### WARNING!

Electrical installation and service behind secured 230 V AC covers must be carried out under the supervision of a qualified electrician.



#### WARNING!

Ensure that the controller and devices connected, or to be connected, are disconnected from the mains before doing any work behind the secured 230 V AC cover.

Most connectors behind the secured cover on the controller are connected to 230 V AC, when the controller is connected to the mains.



#### WARNING!

Do not interchange the connections of the sensors and the 230 V connections under any circumstances. Interchanging these connections may result in life endangering electrical hazards or the destruction of the appliance, the connected sensors and other appliances.



#### NOTE!

Only 230 V Uponor actuators are compatible with the controller.

### 5.2 Attach controller to the wall

The controller is delivered in kits including screws and wall plugs.

#### SCREWS AND WALL PLUGS

The figure below shows controller mounting hole positions, and how to attach it to the wall using screws and wall plugs.

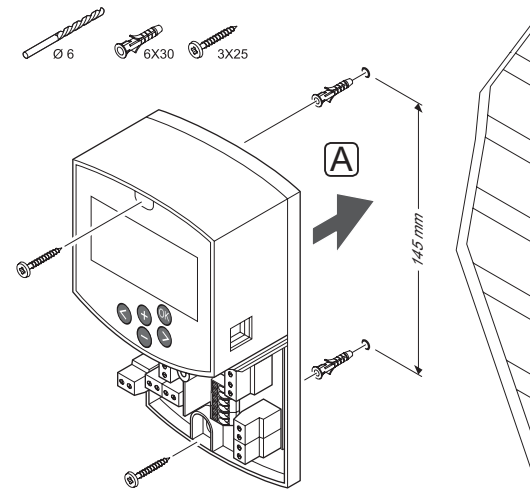

### 5.3 Install controller antenna

The antenna can be attached to the wall, within cable range of the controller, as in the figure below. If the controller is installed inside a metal cabinet, the entire antenna must be placed vertically outside the cabinet.

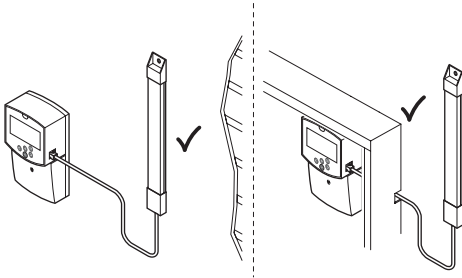

#### CAUTION!

Antenna A-155 must be installed when using a wireless thermostat.



#### NOTE!

The antenna must be installed vertically for best coverage.

#### CONNECT THE ANTENNA CABLE

The illustration below shows how to connect the antenna to the controller.

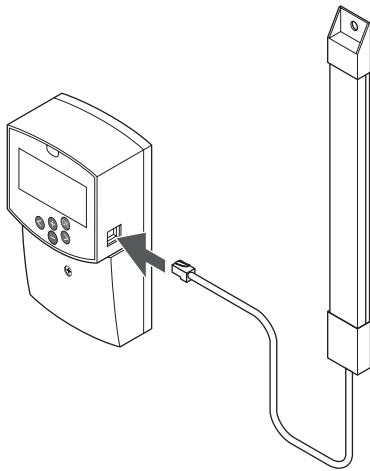

#### ATTACH ANTENNA TO THE WALL

The illustration below shows the antenna attached to the wall with screws (A) or double-sided adhesive strips (B).

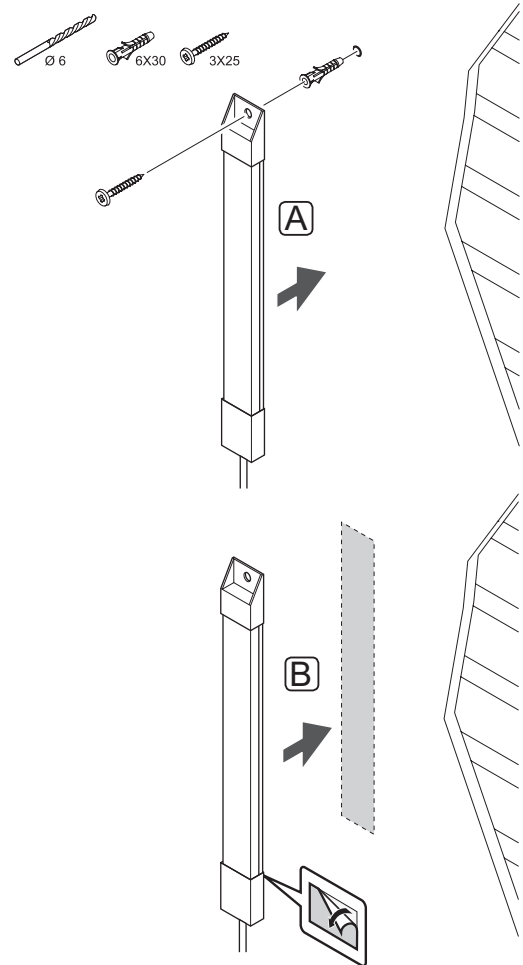

### 5.4 Connect components to controller

Prior to connecting a component, study the wiring diagram, in the end of the manual, or the printed circuit board in the controller, to locate the connector positions. The illustration below shows the controller with removed cover.

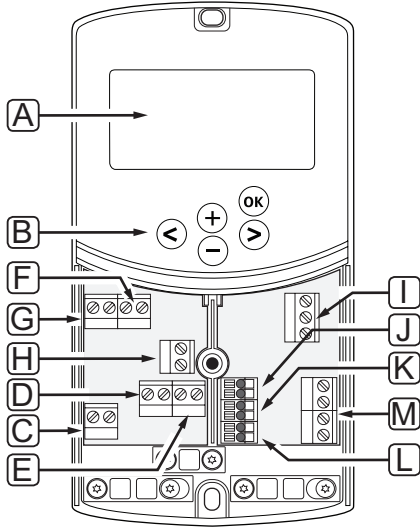

Item	Description
A	Display
B	Buttons
C	Terminal block, earth
D	Terminal block, circulation pump, mixing circuit 1
E	Terminal block, power supply
F	Terminal block, cooling output or various applications
G	Terminal block, heating output
H	Terminal block, optional temperature limiter Fitted from the factory with a cable bridge, which must be removed before connecting a temperature limiter
I	Terminal block, valve actuator
J	Terminal block, outdoor sensor
K	Terminal block, return temperature sensor
L	Terminal block, supply temperature sensor
M	Terminal block, wired inputs 1 and 2 Optional immersion thermostat or external heating/cooling signal

#### ACCESS TERMINAL BLOCKS

To get access to the terminal blocks on the controller, remove the cover, secured by a single screw.

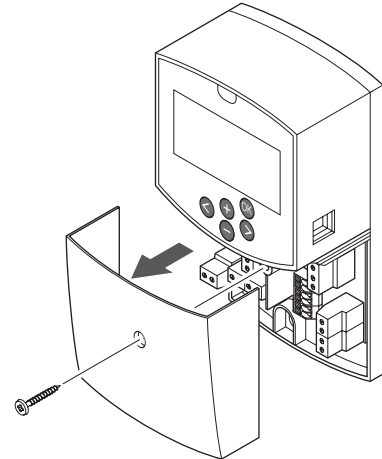

#### CONNECT ACTUATOR TO CONTROLLER

The controller can operate a mixer valve to control the supply temperature.

The illustration below shows the mixer valve actuator connected to the controller.

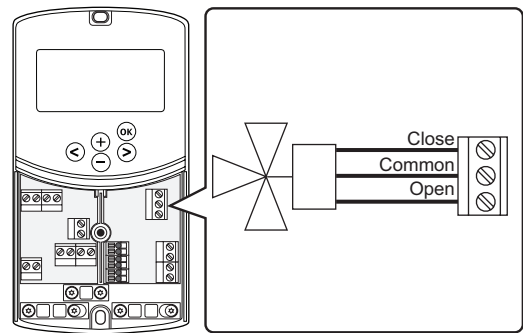

#### WARNING!

There is 230 V (5 A) power in the controller to supply the actuator when the controller is connected to the mains.



#### WARNING!

Electrical installation and service behind secured 230 V AC covers must be carried out under the supervision of a qualified electrician.

1. Ensure that the power is disconnected from both the controller and the actuator.
2. Connect the **CLOSE**, **COMMON**, and **OPEN** wires from the actuator to the corresponding labelled terminal block connections at position **ACTUATOR** in the controller.
3. Secure the wires with a cable clamp in the controller.

### CONNECT CIRCULATION PUMP 1 TO CONTROLLER

The controller can operate a circulation pump, which stops when there is no demand for heating or cooling.



#### NOTE!

See the documentation from the circulation pump supplier as well as relevant Uponor wiring diagrams before connecting the pump.



#### WARNING!

There is 230 V (5 A) power in the controller to supply circulation pump 1 when the controller is connected to the mains.

The illustration below shows the circulation pump connected to the controller.

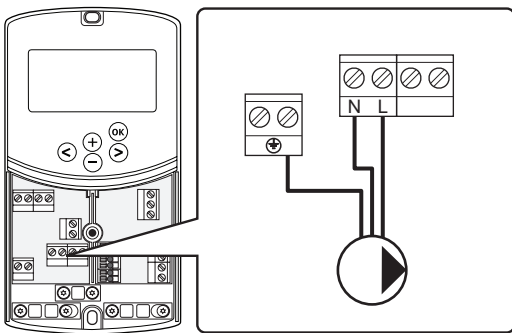

1. Ensure that the power is disconnected from both the controller and the circulation pump.
2. Connect the **L**, **N**, and **Earth** wires from the circulation pump to the corresponding labelled terminal block connections at position **P1** in the controller.
3. Secure the wires with a cable clamp in the controller.

### CONNECT CIRCULATION PUMP 2 TO CONTROLLER (OPTIONAL)

The controller can operate a second circulation pump, which stops when there is no demand for heating or cooling. See section 8.5 System parameter settings for more information.



#### NOTE!

See the documentation from the circulation pump supplier as well as relevant Uponor wiring diagrams before connecting the pump.



#### NOTE!

The second circulation pump can be controlled by an optional extra wireless thermostat (requires antenna A-155).



#### NOTE!

When connecting a second circulation pump, the terminal block connectors will be unavailable for a chiller.



#### WARNING!

There is 230 V (5 A) power in the controller to supply circulation pump 2 when the controller is connected to the mains.

The illustration below shows the circulation pump connected to the controller.

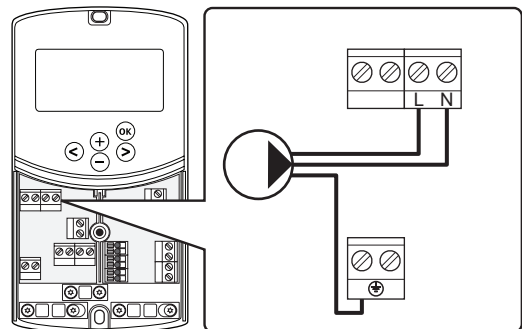

1. Ensure that the power is disconnected from both the controller and the circulation pump.
2. Connect the **L**, **N**, and **Earth** wires from the circulation pump to the corresponding labelled terminal block connections at position **P2/COLD** in the controller.
3. Secure the wires with a cable clamp in the controller.

### CONNECT HEATING SYSTEM OR BOILER TO CONTROLLER (OPTIONAL)

The controller includes a boiler relay. It can be used to send a signal to either fire the heat source or to power open a 2-port motorised zone valve, positioned on the supply to the underfloor heating manifold. If the relay is used to open a zone valve then, the volt free auxiliary contacts on the zone valve should be used to fire the heat source.

Alternatively, the boiler relay can be used to send a demand signal to an electrically operated water temperature controller. The additional contacts on the water temperature controller should then be used to fire the heat source.

- The controller uses a dry contact sensing input on the terminal block to control a heating system or boiler.
- The output uses 230 V (5 A) as a signal to produce heating. The signal from the controller is triggered by a thermostat or an external source connected to inputs **In1** or **In2** in the controller.



#### WARNING!

There is 230 V (5 A) power in the controller to manage the heating system or boiler, when the controller is connected to the mains.



#### NOTE!

See the documentation from the heating system or boiler supplier as well as relevant Uponor wiring diagrams before connecting the heating system or boiler.



#### NOTE!

This connection requires a dry contact sensing input in the boiler.

The illustration below shows the connection of a heating system or boiler to the controller.

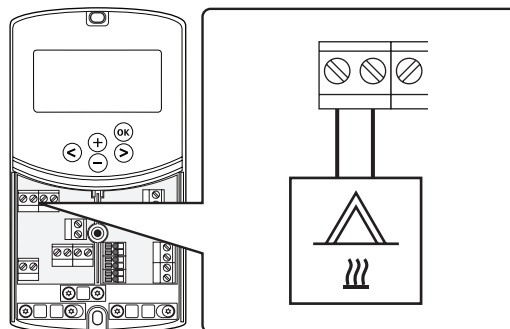

1. Ensure that the power is disconnected from both the controller and the heating system.
2. Connect the boiler to the connection labelled **HEAT** in the controller.
3. Secure the wires with a cable clamp in the controller.

### CONNECT CHILLER OUTPUT TO CONTROLLER (OPTIONAL)

The controller includes a cooling relay. It can be used to signal a chiller to start producing cooling. The controller can switch between heating and cooling by using a heating/cooling input.

See section 8.5 System parameter settings for more information.

- The controller uses a dry contact sensing input on the terminal block to control the chiller.
- The output uses 230 V (5 A) as a signal to produce cooling. The signal from the controller is triggered by a thermostat or an external source connected to inputs **In1** or **In2** in the controller.



#### WARNING!

There is 230 V (5 A) power in the controller to manage the chiller, when the controller is connected to the mains.



#### NOTE!

See the documentation from the chiller supplier as well as relevant Uponor wiring diagrams before connecting the chiller.



#### NOTE!

This connection requires a dry contact sensing input in the chiller.

The illustration below shows the connection of a chiller to the controller.

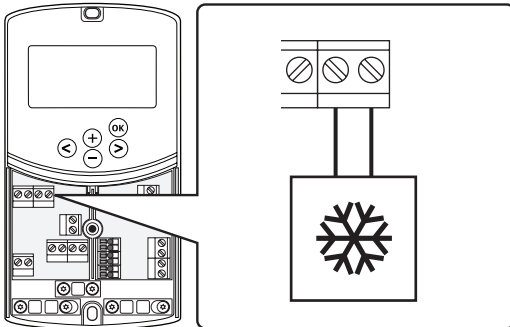

1. Ensure that the power is disconnected from both the controller and the chiller.
2. Connect the chiller to the connection labelled **P2/ COLD** in the controller.
3. Secure the wires with a cable clamp in the controller.

### CONNECT OUTDOOR SENSOR TO CONTROLLER

An outdoor sensor can be connected to the controller in two different ways depending on the controller.

- **Wired**

The outdoor sensor is wired to the controller.

- **Wireless (requires antenna A-155)**

The outdoor sensor is wired to a thermostat, which is communicating with the controller by radio link. See section 6 Install Uponor Smatrix Wave thermostats and sensors for more information.

See section 8.5 System parameter settings for more information.

The illustration below shows the connection of an outdoor temperature sensor to the controller.

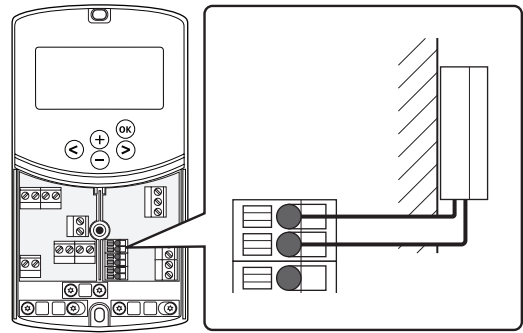

1. Ensure that the power is disconnected from the controller.
2. Connect the outdoor temperature sensor to the terminal block connection at position **OUTSIDE** in the controller
3. Secure the wires with a cable clamp in the controller.



### CONNECT SUPPLY TEMPERATURE SENSOR TO CONTROLLER

A supply temperature sensor can be connected to the controller.

The illustration below shows the connection of a supply temperature sensor to the controller.

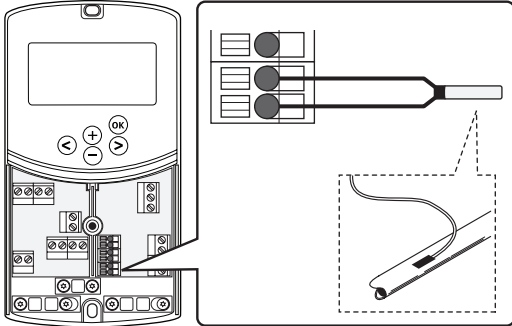

1. Ensure that the power is disconnected from the controller.
2. Connect the supply temperature sensor to the terminal block connection at position **WATER IN** in the controller
3. Secure the wires with a cable clamp in the controller.

### CONNECT RETURN TEMPERATURE SENSOR TO CONTROLLER (OPTIONAL)

A return temperature sensor can be connected to the controller.

If a return temperature sensor is installed, it is possible to use a boost function (only in a system without a wireless thermostat) to quicken the response time of the supply temperature.

See section 8.5 System parameter settings for more information.

The illustration below shows the connection of a return temperature sensor to the controller.

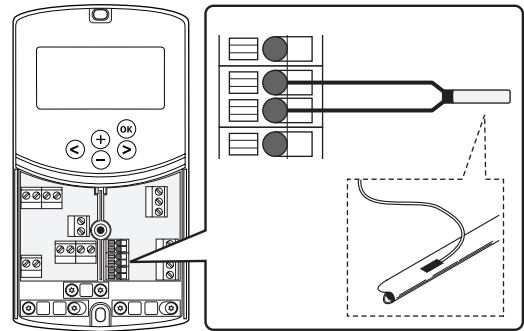

1. Ensure that the power is disconnected from the controller.
2. Connect the return temperature sensor to the terminal block connection at position **WATER RETURN** in the controller
3. Secure the wires with a cable clamp in the controller.

### CONNECT HEATING/COOLING SWITCH TO CONTROLLER (OPTIONAL)

A heating/cooling switch can be connected to one of the two wired input terminals on the controller

Use an external heating/cooling switch to switch the system between heating and cooling mode.



#### NOTE!

This function can only be used in systems without a digital thermostat registered to the controller.

See section 8.5 System parameter settings > 11 Wired Input 1 selection or 12 Wired Input 2 selection for more information.

#### Connection to input 1

The illustration below shows the connection of a heating/cooling switch to terminal In1 and 2 on the controller. A heating/cooling signal is connected to terminal In1 only.

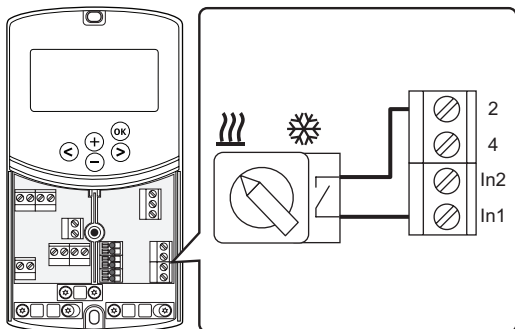

#### Connection to input 2

The illustration below shows the connection of a heating/cooling switch to terminal In2 and 2 on the controller. A heating/cooling signal is connected to terminal In2 only.

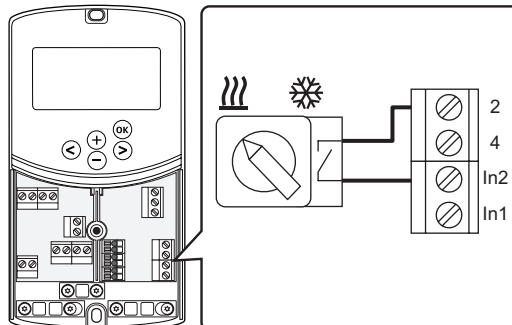

#### To connect the heating/cooling switch:

1. Ensure that the power is disconnected from the controller.
2. Connect the heating/cooling switch to a unused terminal block connection at position **ROOMSTAT** in the controller.
3. Secure the wires with a cable clamp in the controller.

### CONNECT CIRCULATION PUMP START SIGNAL TO CONTROLLER (OPTIONAL)

A circulation pump start signal can be connected to one of the two wired input terminals on the controller.

Use an external circulation pump start signal to switch on and off the circulation pump in the system.

See section 8.5 System parameter settings > 11 Wired Input 1 selection or 12 Wired Input 2 selection for more information.

#### Connection to input 1

The illustration below shows the connection of an external circulation pump start signal to terminal In1 and 2 on the controller. A circulation pump demand signal is connected to terminal In1 only.

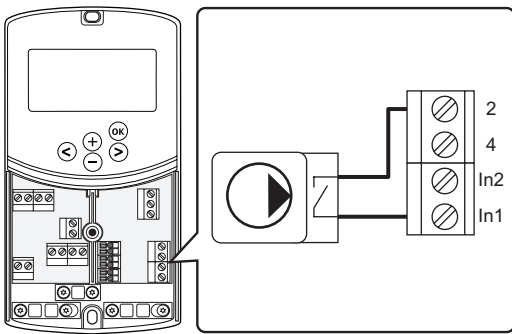

#### Connection to input 2

The illustration below shows the connection of an external circulation pump start signal to terminal In2 and 2 on the controller. A circulation pump demand signal is connected to terminal In2 only.

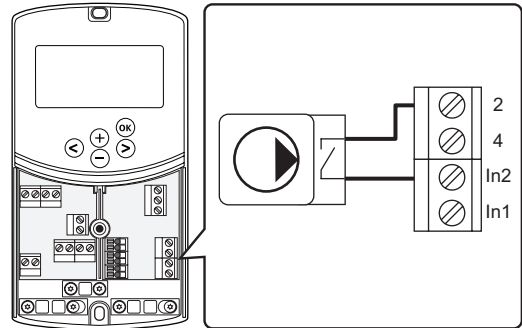

#### To connect the external circulation pump start signal:

1. Ensure that the power is disconnected from the controller.
2. Connect the heating/cooling switch to a unused terminal block connection at position **ROOMSTAT** in the controller.
3. Secure the wires with a cable clamp in the controller.

## 5.5 Connect the controller to AC power



### WARNING!

There is 230 V (5 A) power in the controller when connected to the mains.



### WARNING!

Electrical installation and service behind secured 230 V AC covers must be carried out under the supervision of a qualified electrician.

1. Check that all wiring is complete and correct:
  - Actuator
  - Heating/cooling switch
2. Connect power to the controller according to the illustration below.

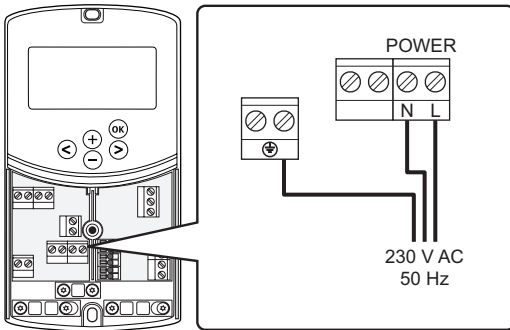

3. Ensure that the 230 V AC compartment of the controller is closed and the fixing screw is tightened.
4. Connect the power cable to a 230 V AC wall socket, or if required by local regulations, to a junction box.

## 5.6 Connect a thermostat to the controller (requires antenna A-155)

The thermostat is connected to the controller through a wireless radio link. The registration process is completed while setting system parameters.

See section 6 *Install Uponor Smatrix Wave thermostats and sensors for installation of thermostats.*

## 5.7 Set system parameters





When the components have been connected, and the controller is powered up, system parameters must be set.

Press and hold the **OK** button until the display starts flashing and the text **Hot type**, **Cld type**, or **rEv type** (depending of current operating mode) is displayed.

See section 8 *Operate the Uponor Smatrix Move controller for more information.*

## 6 Install Uponor Smatrix Wave thermostats and sensors

Only the following thermostats can be connected to a Uponor Smatrix Move system:

	Uponor Smatrix Wave T-169 (digital thermostat with RH T-169)
	Uponor Smatrix Wave T-168 (programmable thermostat with RH T-168)
	Uponor Smatrix Wave T-166 (digital thermostat T-166)
	Uponor Smatrix Wave T-163 (public thermostat T-163)



### CAUTION!

Do not attempt to connect Uponor Smatrix Base thermostats to the controller. They are not suited for each other, and they may get damaged.



### CAUTION!

Antenna A-155 must be installed when registering a wireless thermostat.



### NOTE!

If the outdoor sensor is placed too far away from the reference room, a separate thermostat can be used to register the outdoor sensor.

### 6.1 Placement of thermostats

Refer to the installation preparation guidelines (see *section 4.2 Prepare for installation*), and use the following guidelines when positioning the thermostats:

1. Select an indoor wall and a position 1.3 m to 1.5 m above the floor.
2. Ensure that the thermostat is away from direct solar radiation.
3. Ensure that the thermostat will not be heated through the wall by sunshine.
4. Ensure that the thermostat is away from any source of heat, for example television set, electronic equipment, fireplace, spotlights, and so on.
5. Ensure that the thermostat is away from any source of humidity and water splashes (IP20).
6. Ensure that the thermostat is positioned at least 40 cm away from the controller to avoid interference.

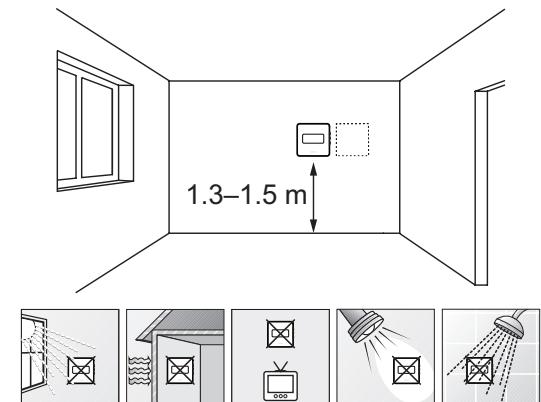

## 6.2 Label thermostats

Label the thermostats, where suitable, with the ID of the connected controller, for example, 1, 2, 3 etc.

If the thermostat can connect to an external sensor, add information about sensor type when applicable.

Available thermostat and sensor combinations:

- Room temperature
- Room and floor temperature (floor temperature display only)
- Room and outdoor temperature
- Remote sensor temperature

## 6.3 Insert batteries

### THERMOSTAT T-169

The thermostats use a single CR2032 3V button cell lithium battery which provides about 2 years of battery life, as long as they are positioned within radio range of the controller. Ensure that the battery is correctly inserted in the thermostat.

The thermostat will perform a self test, for about 10 seconds, when the battery have been inserted. The system will be blocked for input during this period.

The illustration below shows how to remove the plastic transportation strip from the battery, starting the thermostat.

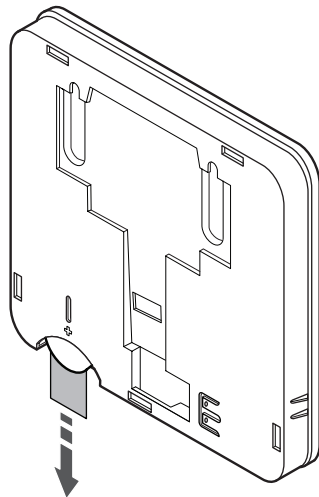

### THERMOSTATS T-163, T-166, AND T-168

The thermostats use two alkaline 1.5 V AAA batteries which provides about 2 years of battery life, as long as they are positioned within radio range of the controller. Ensure that the batteries are correctly inserted in the thermostat.

The thermostat will perform a self test, for about 10 seconds, when the batteries have been inserted. The system will be blocked for input and the thermostat LED flashes during this period.

The illustration below shows how to remove the plastic transportation strip from the batteries, starting the thermostat.

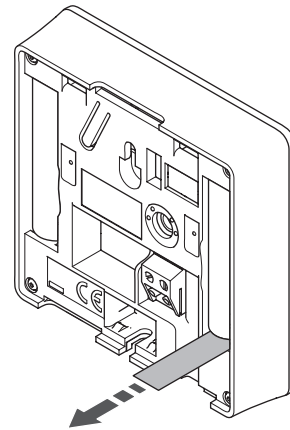

## 6.4 Connect external sensor to thermostat (optional)

An optional external sensor can be connected to the thermostats for extra functionality.



### NOTE!

For accurate temperature: attach the outdoor sensor to the north side of the building where it is unlikely to be exposed to direct sunlight. Do not place it close to doors, windows, or air outlets.

### THERMOSTAT T-169

Connect the sensor to the terminal located at the back of the thermostat, as shown in the illustration below.

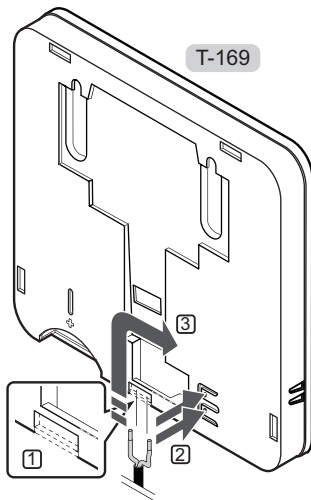

1. Remove the breakout plastic.
2. Press the push buttons on the connection terminals on the back of the thermostat.
3. While pressing the push buttons, insert the two wires from the sensor cable (non polarized) into the connection terminal.

### THERMOSTATS T-166 AND T-168

Connect the sensor to the terminal located at the back of the thermostat, as shown in the illustration below.

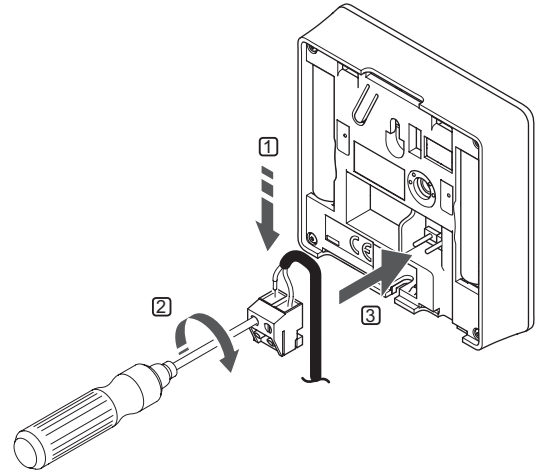

1. Insert the two wires from the sensor cable (non polarized) into the removable connector.
2. Tighten the screws fixing the wires in the connector.
3. Insert the connector on the input pegs on the thermostat.

## 6.5 Sensor input function

### THERMOSTAT T-169

The external temperature sensor input can be used for either a floor (display of temperature only), outdoor or remote temperature sensor. Use the software on the thermostat to select a control mode which corresponds to the use of the sensor and thermostat.

See section 10 Operate Uponor Smatrix Wave digital thermostats for more information.

**THERMOSTAT T-168**

The external temperature sensor input can be used for either a floor (display of temperature only), outdoor or remote temperature sensor. Use the software on the thermostat to select a control mode which corresponds to the use of the sensor and thermostat.

See section 10 Operate Uponor Smatrix Wave digital thermostats for more information.

**THERMOSTAT T-166**

The external temperature sensor input can be used for either a floor (display of temperature only), outdoor or remote temperature sensor. Use the software on the thermostat to select a control mode which corresponds to the use of the sensor and thermostat.

See section 10 Operate Uponor Smatrix Wave digital thermostats for more information.

**THERMOSTAT T-163**

The external temperature sensor input can be used for either an outdoor temperature sensor, or a remote sensor. Use the DIP switches on the thermostat to select a control mode which corresponds to the use of the sensor and thermostat.

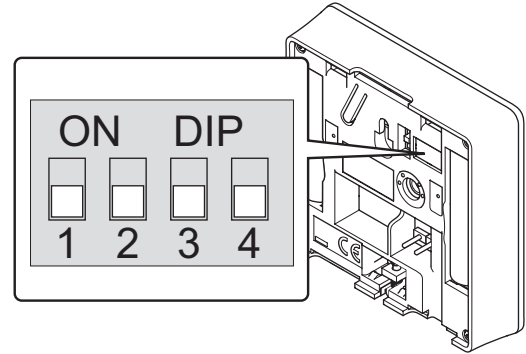

Function	Switch
Room thermostat	
Room thermostat with outdoor temperature sensor	
Remote sensor	

**CAUTION!**

The switches must be set before the thermostat is registered.

**CAUTION!**

The switches must be set to one of the available functions, otherwise the thermostat cannot be registered.



## 6.6 Attach a thermostat to the wall

The thermostats are delivered in kits including screws, wall plugs, and a wall bracket. Presenting several options of attaching the thermostat to the wall.

T-169

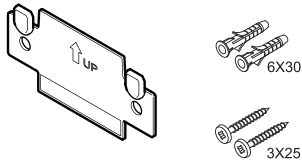

T-168  
T-166  
T-163

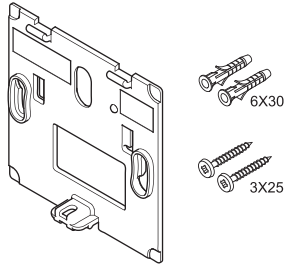

### USING WALL BRACKET (RECOMMENDED)

The illustration below shows thermostat mounting hole positions and how to attach it to the wall using a wall bracket.

T-169

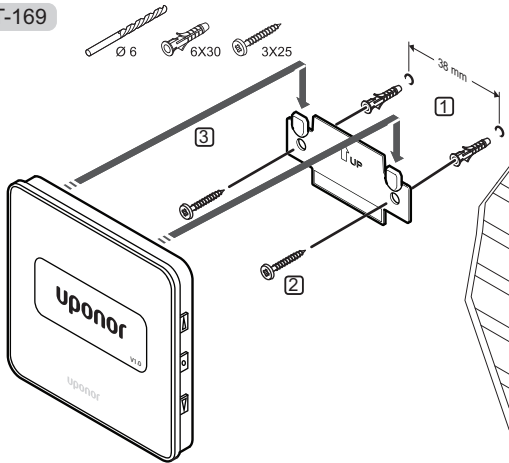

T-168  
T-166  
T-163

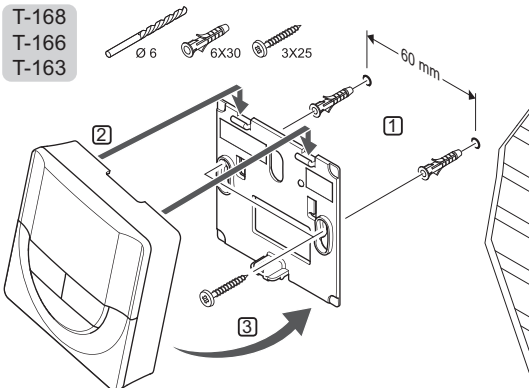

### SCREW AND WALL PLUG

The illustration below shows how to attach the thermostat to the wall using one screw and wall plug.

T-169

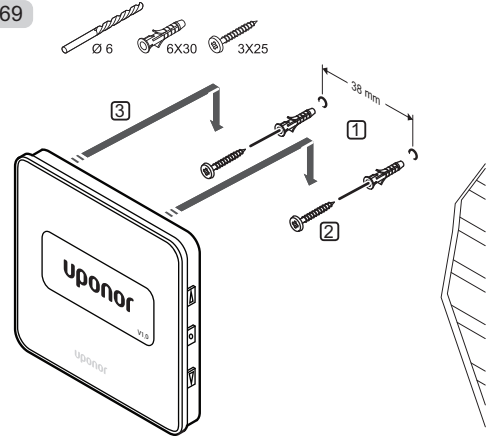

T-168  
T-166  
T-163

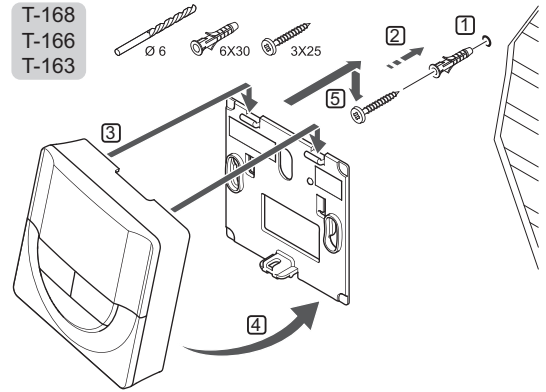

### USING ADHESIVE STRIP

The illustration below shows how to attach the thermostat to the wall using an adhesive strip and a wall bracket.

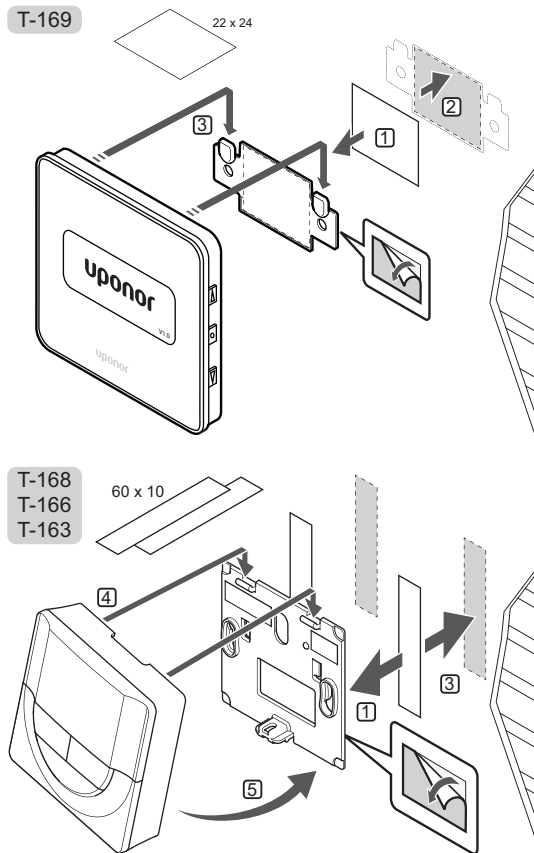

### 6.7 Attach to table stand (T-163, T-166, and T-168 only)

The illustration below shows how to attach the thermostat to a table stand.

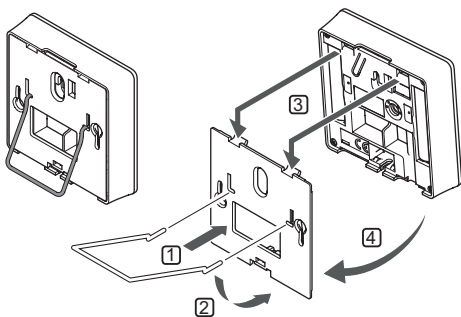

### 6.8 First startup of digital thermostats

At first startup, before registering, the thermostat requires some basic settings.

See section 12 Operate Uponor Smatrix Wave digital thermostats for more information.

#### SOFTWARE VERSION

Current software version is displayed during power up.

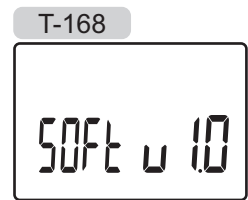
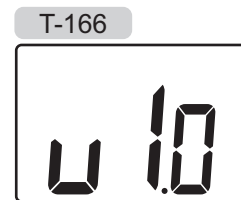

**SET TIME (T-168 ONLY)**

When starting the thermostat for the first time, after a factory reset, or after it has been left without batteries too long, the software requires the time and date to be set. This setting is required to utilise scheduling programs for this thermostat.

Use buttons - or + to change the value, press the **OK** button to set the value and move to the next editable value.

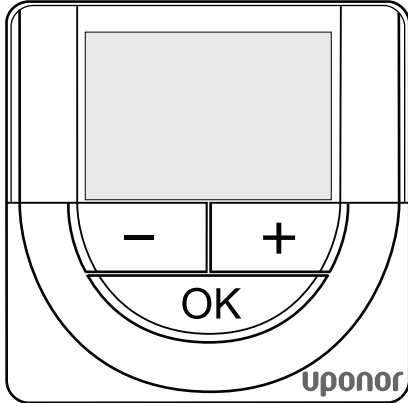
**NOTE!**

If no button is pressed for about 8 seconds, the current values will be saved and the software exits to control mode.

1. Set hours.



2. Set minutes.



3. Set 12 h or 24 h display of time.



4. Set day of the week (1 = Monday, 7 = Sunday).



5. Set day of the month.



6. Set month.



7. Set year.



8. Press **OK** to return to run mode.

Date and time can also be set in the settings menu.

## 6.9 First setup of digital thermostat

### SELECT THERMOSTAT CONTROL MODE

If an external sensor is connected to the thermostat, a control mode must be selected to accommodate the extra functionality of the sensor.



#### NOTE!

If no button is pressed for about 8 seconds, while in a submenu, the current values will be saved and the software exits to the settings menu. About about 60 seconds later, it exits to run mode.

1. Press and hold the **OK** button until the settings icon and menu numbers is displayed in the top right corner of the display (about 3 seconds).
2. Use buttons - or + (T-169 = ▼ or ▲) to change the numbers to **04** and press **OK**.
3. Current control mode is displayed (RT, RFT, RS or RO).
4. Use buttons - or + (T-169 = ▼ or ▲) to change control mode (see list below) and press **OK**.

T-169	T-166/ T-168	Description
	RT	Room temperature
	RFT	Room temperature with external floor sensor
	RS	Remote sensor
	RO	Room temperature with remote outdoor sensor

5. Press and hold the **OK** button for about 3 seconds to exit the settings menu.

### SETPOINT TEMPERATURE

The thermostat is delivered with a default setpoint of 21 °C.

The illustration below shows how to adjust the thermostat temperature setpoint.

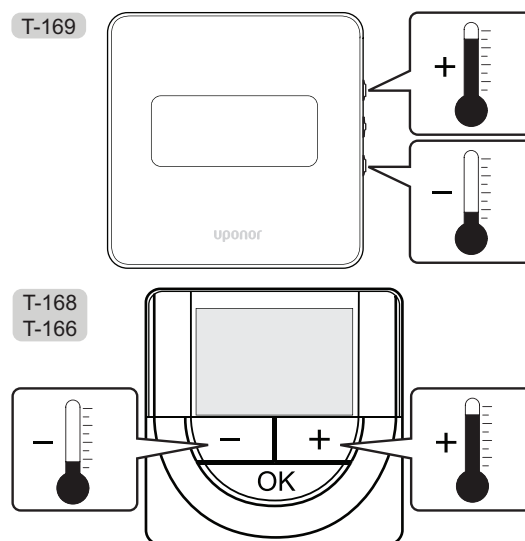

To adjust the thermostat temperature setpoint of the current control mode:

1. Press the - or + (T-169 = ▼ or ▲) button once. The screen shows the current setpoint flashing.

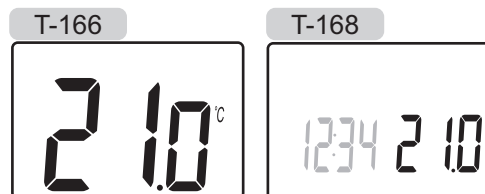
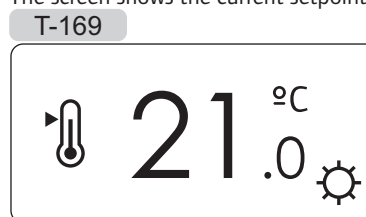

2. Press the - or + (T-169 = ▼ or ▲) button repeatedly to adjust the setpoint temperature. It will change with increments of 0.5.

When the new setpoint is set, the screen returns to run mode after a few seconds, showing the room temperature.

### 6.10 Register a thermostat to the controller

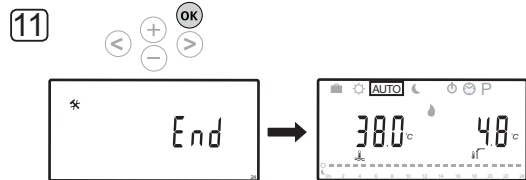
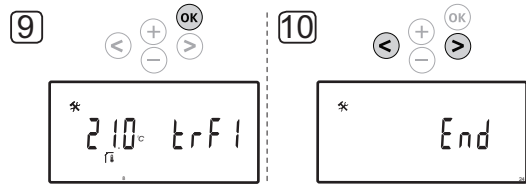
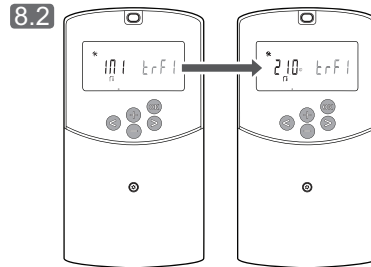
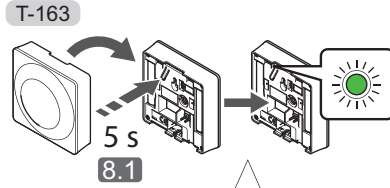
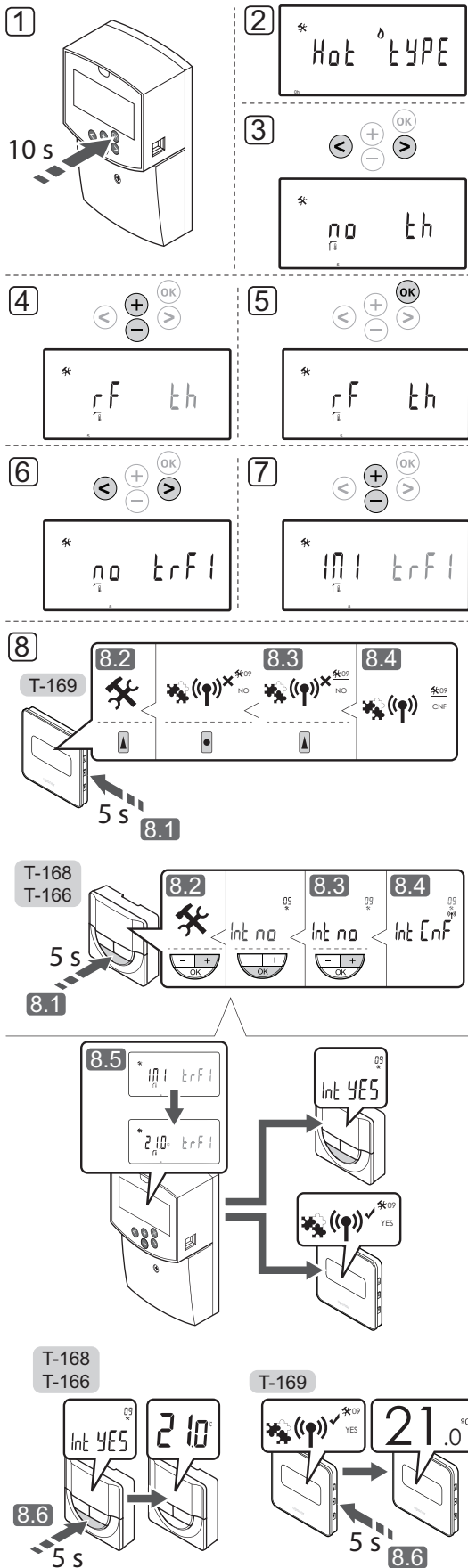

**CAUTION!**  
The DIP switches in public thermostat T-163 must be set before the thermostat is registered.

**CAUTION!**  
Do not attempt to connect Uponor Smatrix Base thermostats to the controller. They are not suited for each other, and they may get damaged.

**CAUTION!**  
Antenna A-155 must be installed when registering a wireless thermostat.

**NOTE!**  
When registering a thermostat to the controller, run mode changes parameter **0 (type)** to **rEv**, regardless of previous setting. Heating/cooling is then controlled by the thermostat, or the integrated system.

**NOTE!**

If the outdoor sensor is placed far away from the reference room, a separate thermostat can be used to register the outdoor sensor.

**NOTE!**

Repeating the registration process will replace the old registration data.

**NOTE!**

If no button is pressed on the controller for about 4 minutes, the software exits to run mode.

To register a thermostat to the controller:

1. Press and hold the **OK** button on the controller for about 10 seconds to enter the system parameters menu.
2. The settings icon is displayed in the top left hand corner of the display, and the text **Hot type, Cld type, or rEv type** (depending of current operating mode) is displayed.
3. Use buttons **<** or **>** to locate parameter **5 (th)** – Type of thermostat.
4. Use buttons **-** or **+** to change parameter settings to **rf**.
5. Press the **OK** button on the controller to confirm the change and return to the system parameter settings.
6. Use buttons **<** or **>** to locate parameter **8 (trF1)** – Wireless thermostat 1 configuration.
7. Use buttons **-** or **+** to change parameter settings to **INI**.
8. Select a thermostat

**THERMOSTAT T-166, T-168, AND T-169**

- 8.1 Press and hold the **OK** button on the thermostat for about 5 seconds to enter the settings menu. The settings icon and menu numbers are displayed in the top right corner of the display.
- 8.2 Use buttons **-** or **+** (T-169 = **▼** or **▲**) to change the numbers to **09** and press **OK**. The text **Int no** is displayed.
- 8.3 Use buttons **-** or **+** (T-169 = **▼** or **▲**) to change **Int no** to **Int CNF**.

- 8.4 The connection indicator is shown in the thermostat display (starts flashing in thermostats T-166 and T-168) to show that the registration process begins.
- 8.5 The current reference room temperature is shown in the controller display, and the text **Int YES** is shown in the thermostat display when the registration is complete.
- 8.6 Press and hold the **OK** button on the thermostat for about 5 seconds to exit the settings menu, or wait about 70 seconds for the software to exit itself.

**THERMOSTAT T-163**

- 8.1 Gently press and hold the registration button on the thermostat, release when the LED starts flashing green (located in the hole above the registration button).
- 8.2 The current reference room temperature is shown in the controller display when the registration is complete. It might take some time for the thermostat to send the current temperature data to the controller. 00.0 is displayed in the meantime.
9. Press the **OK** button on the controller to confirm the change and return to the system parameter settings.
10. Use buttons **<** or **>** to locate parameter **24 (End)** – Exit system parameter settings.
11. Press the **OK** button to exit the system parameters menu.

To unregister already registered thermostats and/or sensors, perform a factory reset on both the controller and thermostats.

*See section 8.6 System parameter settings > 23 – Factory reset for more information about the controller.*

*See section 9.4 Factory reset, for more information about analogue thermostats.*

*See section 10.11 Factory reset, for more information about digital thermostats.*

### 6.11 Register a wireless outdoor sensor to the controller

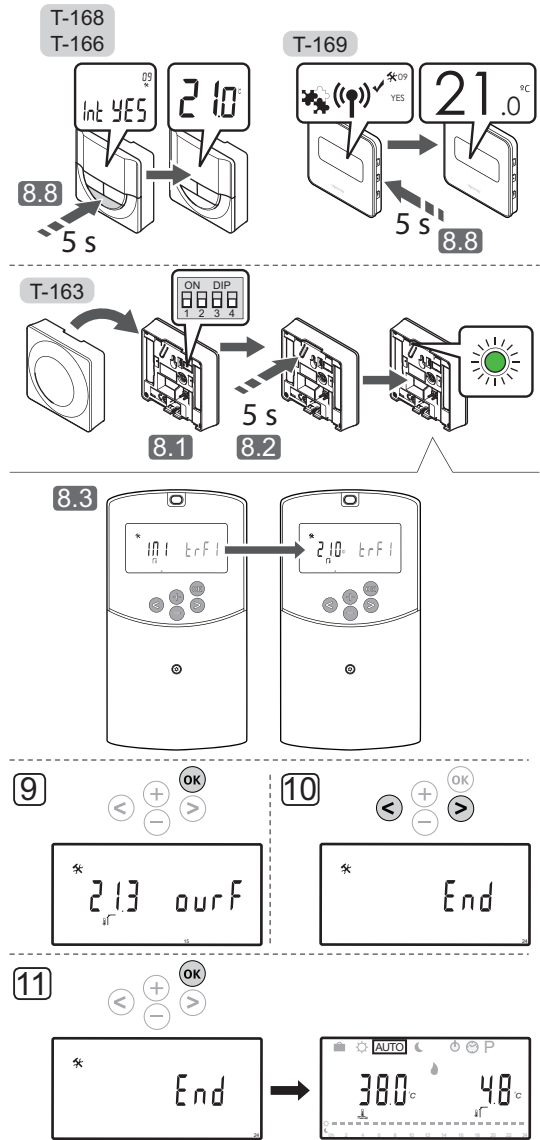
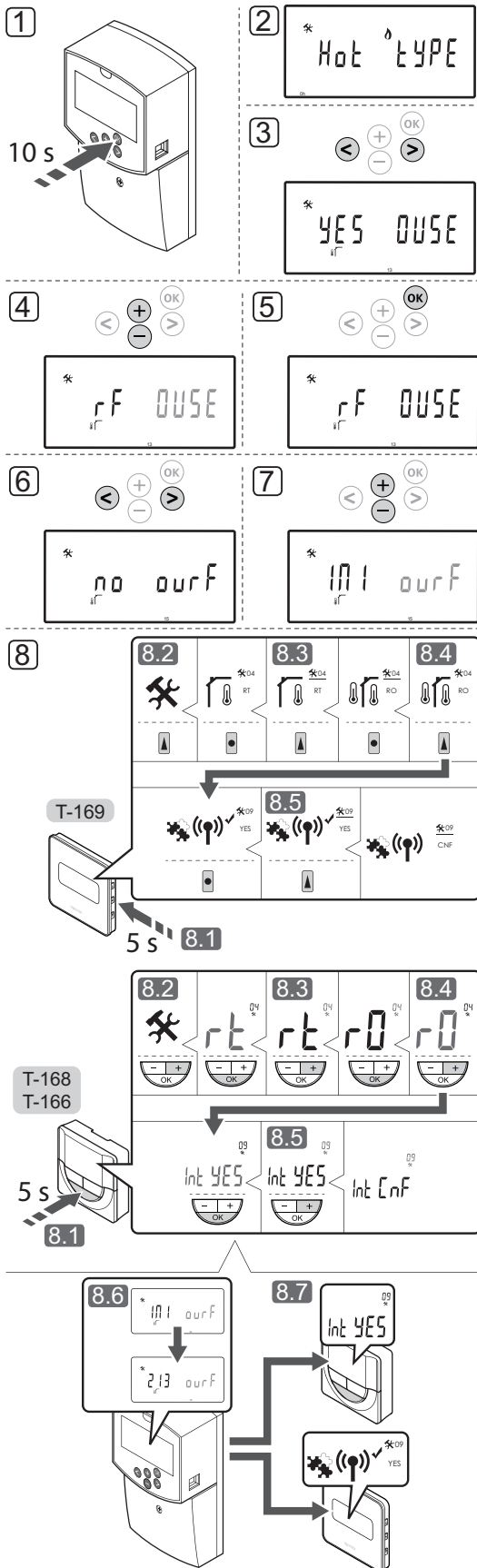

**CAUTION!**  
The DIP switches in public thermostat T-163 must be set before the thermostat is registered.

**CAUTION!**  
Antenna A-155 must be installed when registering a wireless thermostat.

**NOTE!**  
If the outdoor sensor is placed too far away from the reference room, a separate thermostat can be used to register the outdoor sensor.

**NOTE!**

Repeating the registration process will replace the old registration data.

**NOTE!**

If no button on the controller is pressed for about 4 minutes, the software exits to run mode.

To register a wireless outdoor sensor to the controller:

1. Press and hold the **OK** button on the controller for about 10 seconds to enter the system parameters menu.
2. The settings icon is displayed in the top left hand corner of the display, and the text **Hot type, Cld type, or rEv type** (depending of current operating mode) is displayed.
3. Use buttons < or > to locate parameter **13 (OUSE)** – Outdoor sensor selection.
4. Use buttons - or + to change parameter settings to **rf**.
5. Press the **OK** button on the controller to confirm the change and return to the system parameter settings.
6. Use buttons < or > to locate parameter **15 (ourF)** – Wireless outdoor sensor configuration.
7. Use buttons - or + to change parameter settings to **INI**.
8. Select a thermostat

**THERMOSTAT T-166, T-168, AND T-169**

- 8.1 Press and hold the **OK** button on the thermostat for about 5 seconds to enter the settings menu. The settings icon and menu numbers are displayed in the top right corner of the display.
- 8.2 Use buttons - or + (T-169 = ▼ or ▲) to change the numbers to **04** and press **OK**. Current control mode is displayed (**RT, RFT, RS** or **RO**).
- 8.3. Use buttons - or + (T-169 = ▼ or ▲) to change control mode to **RO** and press **OK**.
- 8.4 Use buttons - or + (T-169 = ▼ or ▲) to change the numbers to **09** and press **OK**. The text **Int YES** is displayed, if the thermostat already is registered as a reference room thermostat.
- 8.5. Use buttons - or + (T-169 = ▼ or ▲) to change **Int no** to **Int CNF**.

8.6. The connection indicator is shown in the thermostat display (starts flashing in thermostats T-166 and T-168) to show that the registration process begins.

8.7 The current reference room temperature is shown in the controller display, and the text **Int YES** is shown in the thermostat display when the registration is complete.

8.8 Press and hold the **OK** button on the thermostat for about 5 seconds to exit the settings menu, or wait about 70 seconds for the software to exit itself.

**THERMOSTAT T-163**

- 8.1 Make sure the DIP switch is set correctly.
- 8.2 Gently press and hold the registration button on the thermostat, release when the LED starts flashing green (located in the hole above the registration button).
- 8.3 The current outdoor temperature is shown in the controller display when the registration is complete. It might take some time for the thermostat to send the current temperature data to the controller. 00.0 is displayed in the meantime.
9. Press the **OK** button on the controller to confirm the change and return to the system parameter settings.
10. Use buttons < or > to locate parameter **24 (End)** – Exit system parameter settings.
11. Press the **OK** button to exit the system parameters menu.

To unregister already registered thermostats and/or sensors, perform a factory reset on both the controller and thermostats.

*See section 8.6 System parameter settings > 23 – Factory reset for more information about the controller.*

*See section 9.4 Factory reset, for more information about analogue thermostats.*

*See section 10.11 Factory reset, for more information about digital thermostats.*



## 6.12 Register a wired outdoor sensor

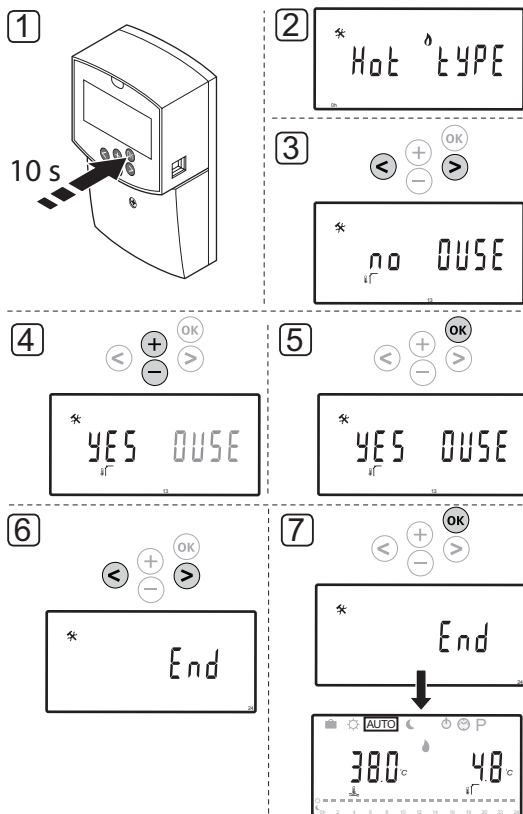

### CAUTION!

Antenna A-155 must be installed when registering a wireless thermostat.



### NOTE!

If no button on the controller is pressed for about 4 minutes, the software exits to run mode.

To register a wired outdoor sensor to the controller:

1. Press and hold the **OK** button on the controller for about 10 seconds to enter the system parameters menu.
2. The settings icon is displayed in the top left hand corner of the display, and the text **Hot type, Cld type**, or **rEv type** (depending of current operating mode) is displayed.
3. Use buttons **<** or **>** to locate parameter **13 (OUSE)** – Outdoor sensor selection.
4. Use buttons **-** or **+** to change parameter settings to **YES**.
5. Press the **OK** button on the controller to confirm the change and return to the system parameter settings.
6. Use buttons **<** or **>** to locate parameter **24 (End)** – Exit system parameter settings.
7. Press the **OK** button to exit the system parameters menu.

To unregister already registered thermostats and/or sensors, perform a factory reset on both the controller and thermostats.

See section 8.6 System parameter settings > 23 – Factory reset for more information about the controller.

See section 9.4 Factory reset, for more information about analogue thermostats.

See section 10.11 Factory reset, for more information about digital thermostats.

## 7 Finishing installation

### 7.1 Uponor Smatrix Move (wired)

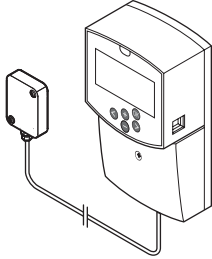

Make a complete check up of the installation:

1. Close the cover of the controller.
2. Set the controller to the defined operating settings.
3. Print and fill in the "Installation report" located at the end of the manual.
4. Give the manual and all information about the system to the user.

### 7.2 Uponor Smatrix Move (wireless)

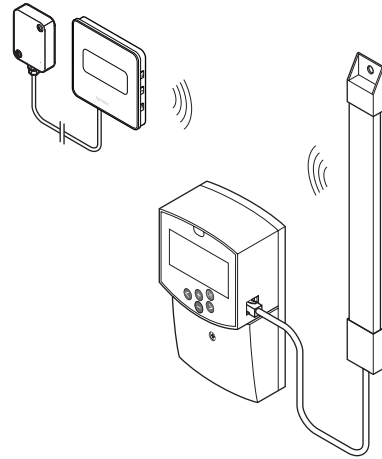

Make a complete check up of the installation:

1. Close the cover of the controller.
2. Set the controller and thermostat to the defined operating settings.
3. Check that the thermostats are working correctly.  
Turn thermostat set points to maximum to obtain a heating demand and make sure that the actuators are running.
4. Print and fill in the "Installation report" located at the end of the manual.
5. Give the manual and all information about the system to the user.

# 8 Operate the Uponor Smatrix Move controller

## 8.1 Principle of operation

Uponor Smatrix Move is used to control an underfloor heating and/or cooling system in a house.

The controller calculates the supply temperature using the outdoor temperature and a heating curve. The calculated supply temperature is compared to the measured supply temperature. If the measured temperature differs from the calculated, the controller adjusts the flow through the mixer valve to raise or lower the supply temperature.

If a thermostat is present in the system (requires antenna A-155), it is also used to further adjust the flow to the reference room and to reach the setpoint quicker.

As soon as the temperature measured at the thermostat is lower (heating mode) or higher (cooling mode) than the setpoint temperature, a demand to change the room temperature is created and sent to the controller. The controller will open the actuator according to current operating mode and other settings. Once the set temperature is reached, the actuator closes.

## 8.2 Controller layout

The illustration below shows parts of the controller.

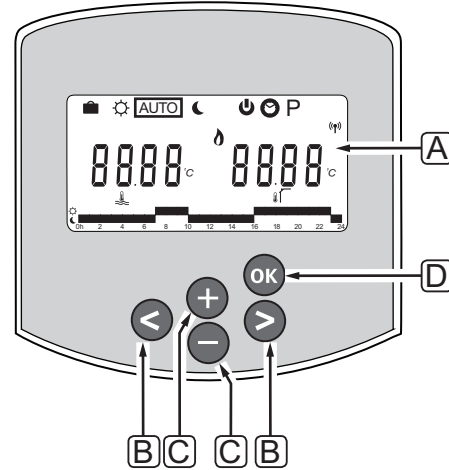

Item	Description
A	Display
B	Navigation buttons Used for selecting mode, parameter, and scheduling program
C	The - and + buttons are used to: <ul style="list-style-type: none"> <li>Adjust setpoint temperature</li> <li>Modify parameters in the settings menus</li> </ul>
D	The OK button is used to: <ul style="list-style-type: none"> <li>Toggle between current status data, and values of available sensors connected to the controller</li> <li>Enter and exit the settings menu</li> <li>Confirm a setting</li> </ul>

### 8.3 Display layout

The figure below shows all possible symbols and characters that can be shown on the display:

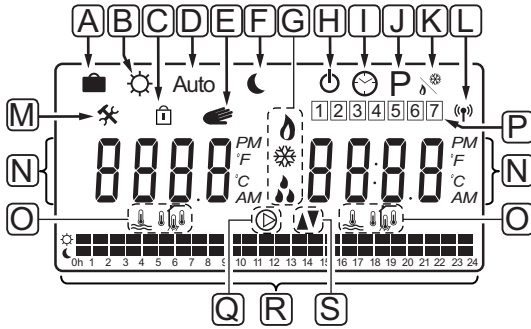

Pos.	Icon	Description
A		Holiday mode
B		Comfort mode
C		Locked system parameter
D	Auto	Automatic mode
E		Forced operation
F		ECO mode
G		Heating demand
		Cooling demand
		Relative humidity function active. This function requires a cooling demand and RH signal from an integrated system to activate
H		Stop mode
I		Time and day settings
J	P	Scheduled programs menu
K		Heating/cooling mode
L		Communication indicator
M		Settings menu

Pos.	Icon	Description
N	8888	Temperature
	8888	Relative humidity
	88:88	Digital clock
	8888	Parameter name in settings menu
	PM	Indicator showing AM or PM when the thermostat is set to 12 h mode
	AM	Indicator showing AM or PM when the thermostat is set to 12 h mode
		24 hour mode (no symbol shown)
	°C	Temperature unit, shown when the character group N shows a temperature
	°F	Temperature unit, shown when the character group N shows a temperature
O		Supply temperature indicator
		Outdoor temperature indicator
		Floor temperature indicator
		Indoor temperature indicator
P	1	Current/selected/activated day of the week 1 = Monday 7 = Sunday
Q		Circulation pump activated
R		Scheduling Comfort mode
		Scheduling ECO mode
S		Mixer valve is opening
		Mixer valve is closing

### 8.4 Start up

When starting up, the controller enters run mode.

See section 8.6 System parameter settings for more information

## 8.5 Run mode

Press any button to light up the display and to show the current run mode. In run mode different operating modes can be selected, as well as setting current time and day, and selecting a scheduling program.

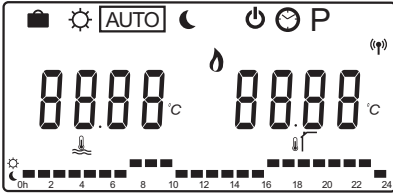

### OPERATING MODES

Use buttons < or > to change operating mode. A box shows which mode has been selected.

Available operating modes and settings in run mode are the following.

Icon	Operating mode
	Holiday mode
	Comfort mode
Auto	Automatic mode (default)
	ECO mode
	Stop mode
	Time and day settings
P	Scheduled programs menu
	Heating/cooling mode This mode requires system parameter 0 – Type of installation being set to <b>rEv</b> , but is hidden if a wireless thermostat is registered to the controller, or if system parameters 11 or 12 is set to <b>HC</b> .

### Supply temperature

The supply temperature in the system is calculated using system settings, sensors and thermostats, if available.

Sometimes an offset is needed to adjust the selected heating and cooling curve to be a better fit for the system. The offset is set in **Comfort mode** but is also used in other modes where Comfort mode can be activated.

Minimum and maximum settings may limit the calculated supply temperature.

See section 8.6 System parameter settings for more information

Systems with a supply temperature sensor only:

- The supply temperature is calculated using a fixed set outdoor temperature (**System parameters > OUt**) with the heating and cooling curve (**System parameters > Cur**).

Systems with a supply temperature sensor and an outdoor sensor only:

- The supply temperature is calculated using the outdoor temperature with the heating and cooling curve (**System parameters > Cur**).

Systems with a supply temperature sensor, an outdoor temperature sensor and a thermostat (requires antenna A-155):

- The supply temperature is calculated using the outdoor temperature with the heating and cooling curve (**System parameters > Cur**) as a base. To get the final supply temperature, the difference between the thermostat setpoint and current room temperature is multiplied with a thermostat compensation value, and added to the base.

### ECO setback temperature



Whenever the system is set in **ECO mode** or **Holiday mode** a setback temperature is used.

The ECO setback temperature is set in **ECO mode**.

### HOLIDAY MODE

In this mode, a time period of 1 hour up to 44 days can be set for when away on holiday.

When activated, the controller attempts to reduce the system energy need by setting a different setpoint temperature for the system, using the offset temperature set in **ECO mode**.

The  and  symbols starts flashing when holiday mode is activated, and the set value starts counting down. The value counts down starting with days, then the final hours, to the final 59 minutes. When finished, the controller automatically switches back to the previously selected operating mode.

#### To activate holiday mode:

1. Press the < button repeatedly until the suitcase symbol  is marked in the display. The ECO setpoint and the text **no** is displayed.
2. Use buttons - or + to set the number of hours or days away.

*Default: no*

*Setting range: no, 1 – 23h (hours), 1 – 44d (days)*

3. When the new time away is set, stop pressing buttons, the controller starts counting down when a value is changed.

#### To change time away during holiday mode:

1. Use buttons - or + to change the number of hours or days away.  
*Setting range: no, 1 – 23h (hours), 1 – 44d (days)*
2. When the new time away is set, stop pressing buttons, the controller starts counting down when a value is changed.

#### To deactivate holiday mode:

1. Press and hold the - button until the text **no** appears instead of hours or days.
2. Press the > button to change operating mode.

### COMFORT MODE

In this mode the system will run in constant Comfort mode. To exit Comfort mode, use buttons < or > to change operating mode.

When entering the Comfort mode menu, the calculated supply temperature is shown and the supply temperature offset starts flashing for about 7 seconds. Changes to the offset can be made if initiated during this time period.

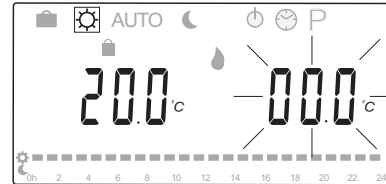

When exiting the initial edit mode, by either waiting for about 7 seconds or by pressing the **OK** button, the controller shows the current supply and outdoor temperatures. Use the **OK** button to toggle between the edit and display modes.

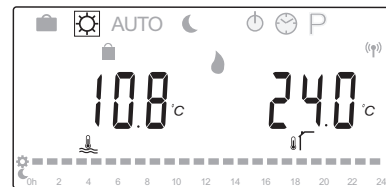

#### Operation without a room thermostat

If the system is operating in heating mode without a room thermostat, the circulation pump (P1) is running continuously. If the system requires the pump to switch off for a set number of minutes when the mixer valve is closed, it can be set in **System parameters > Pump delay time**. The circulation pump then restarts after each set interval to maintain the supply flow and temperature. If the current temperatures fall below the setpoints, the circulation pump will start again and run continuously.

### Change offset temperature when in another operating mode:

1. Use buttons < or > to move the marker to the Comfort mode symbol ☀️. The calculated supply temperature is shown and the supply temperature offset starts flashing for about 7 seconds.
2. Use buttons - or + to change the offset temperature.

Default: 0.0 °C

Setting range: -10.0 – 10 °C

3. Press the **OK** button or wait about 7 seconds until the new setting is confirmed.

Current supply and outdoor temperatures, and the forced operation symbol is displayed.

4. Use buttons < or > to get back to the previously used operating mode.

### Change offset temperature when in constant Comfort mode:

1. Use buttons -, + or **OK** to enter edit mode. The calculated supply temperature is shown and the supply temperature offset starts flashing for about 7 seconds.

2. Use buttons - or + to change the offset temperature.

Default: 0.0 °C

Setting range: -10.0 – 10 °C

3. Press the **OK** button or wait about 7 seconds until the new setting is confirmed.

Current supply and outdoor temperatures, and the forced operation symbol is displayed.

### AUTOMATIC MODE

In this mode, the system switches automatically between Comfort and ECO mode using the preset or user defined scheduling programs available in the **Scheduled programs menu**.

When entering the automatic mode menu, the calculated supply and the current outdoor temperature is shown for about 7 seconds.

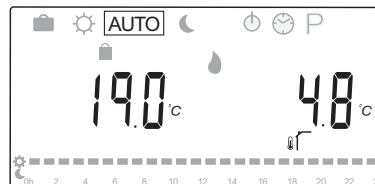

After these 7 seconds the current supply temperature will be displayed instead of the calculated. The **OK** button can be used to toggle between these two values at any time, when in **Automatic mode**.

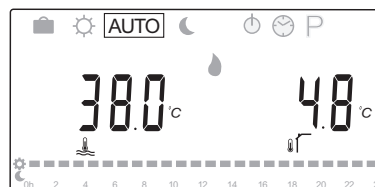

Current time of the day will flash continuously at the bottom of the screen showing which mode is currently active (Comfort or ECO). This requires the time and day to be set and a scheduled program to be selected.

**To set time and day:**

1. Press the > button repeatedly until the clock symbol  is marked in the display. A digital clock and the number 1 through 7 is shown on the right hand side of the display.

1 2 3 4 5 6 7



3. Use buttons - or + to set the minutes.
4. Press the **OK** button to confirm, the hours starts flashing.

1 2 3 4 5 6 7



5. Use buttons - or + to set the hours.
6. Press the **OK** button to confirm, the days of the week starts flashing.

1 2 3 4 5 6 7



7. Use buttons - or + to set the day of the week (1 = Monday, 7 = Sunday).
8. Press the **OK** button to confirm, the days of the week stop flashing.
9. Use buttons < or > to get back to **Automatic mode**, or wait about 7 seconds for the controller to revert automatically.

**To select a scheduling program:**

1. Press the > button repeatedly until the scheduling program symbol **P** is marked in the display. One of the available scheduling programs are available.

2. Use buttons -, + or **OK** to enter selection mode. The selected program number starts flashing.

3. Use buttons - or + to select a scheduling program.

Use buttons < or > to preview the days of a scheduling program.

Available programs: P1 – P9 (preset), U1 – U4 (user defined).

4. Press the **OK** button to confirm selection of scheduled program. If a user defined program (U1 – U4) is selected, go to step 4.1.

4.1 If the selected user defined program is not in need of change, press the **OK** button 7 times until the digital clock disappears.

Otherwise, see section 8.5 Run mode >

*Scheduling programs > User defined programs for more information on how to create an own program.*

5. Use buttons < or > to get back to **Automatic mode**, or wait about 7 seconds for the controller to revert automatically.

*See section 8.5 Run mode > Scheduling programs for more information*



## ECO MODE

In this mode the system will run in constant ECO mode. To exit ECO mode, use buttons < or > to change operating mode.

When entering the ECO mode menu, the calculated supply temperature is shown, with the ECO setback temperature subtracted, and the ECO setback temperature start flashing for about 7 seconds. Changes to the setback temperature can be made if initiated during this time period.

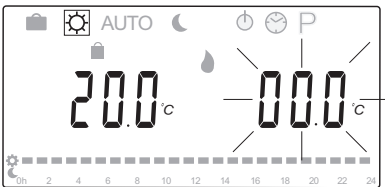

When exiting the initial edit mode, by either waiting about 7 seconds or by pressing the **OK** button, the controller shows the current supply and outdoor temperatures. Use the **OK** button to toggle between the edit and display modes.

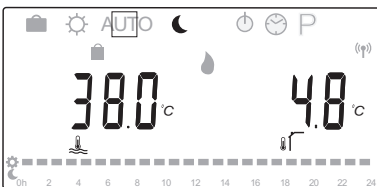

## Operation without a room thermostat

If the system is operating in heating mode without a room thermostat, the circulation pump (P1) is running continuously. If the system requires the pump to switch off for a set number of minutes when the mixer valve is closed, it can be set in **System parameters > Pump delay time**. The circulation pump then restarts after each set interval to maintain the supply flow and temperature. If the measured temperatures fall below the setpoints, the circulation pump will start again and run continuously.

## Change ECO setback temperature when in another operating mode:

1. Use buttons < or > to move the marker to the ECO mode symbol ☾. The calculated supply temperature is shown and the ECO setback temperature starts flashing for about 7 seconds.
2. Use buttons - or + to change the ECO setback temperature.

*Default (heating mode): -10.0 °C*

*Default (cooling mode): -3.0 °C*

*Setting range: -25.0 – 0 °C*

3. Press the **OK** button or wait about 7 seconds until the new setting is confirmed.

Current supply and outdoor temperatures is displayed.

4. Use buttons < or > to get back to the previously used operating mode.

## Change ECO setback temperature when in constant ECO mode:

1. Use buttons -, + or **OK** to enter edit mode. The calculated supply temperature is shown and the ECO setback temperature starts flashing for about 7 seconds.
2. Use buttons - or + to change the ECO setback temperature.

*Default (heating mode): -10.0 °C*

*Default (cooling mode): -3.0 °C*

*Setting range: -25.0 – 0 °C*

3. Press the **OK** button or wait about 7 seconds until the new setting is confirmed.

Current supply and outdoor temperatures is displayed.

## STOP MODE

In this mode the software version is shown for about 5 seconds, before everything in the display, except the Stop mode symbol , is switched off.

The mixer valve reverts to default position, the circulation pump and other connected system devices are switched off.

### To exit stop mode:

1. Press any button on the controller to light up the display.
2. Use buttons < or > to select an operating mode.



#### NOTE!

If **Stop mode** is activated while in heating mode, an anti-freeze function can operate the heat relay and circulation pump to maintain a supply temperature above 10 °C.

## HEATING/COOLING MODE

In this mode the system can be switched between heating or cooling.



#### CAUTION!

Before changing heating/cooling mode on the controller, make sure any heating and/or cooling products (heat pump etc) present in the system, and not controlled by the controller, is switched off, or has its operating mode changed. The system may otherwise behave incorrectly.



#### NOTE!

This mode requires system parameter 0 – Type of installation being set to **rEv**.



#### NOTE!

This mode is hidden if a wireless thermostat (requires antenna A-155) is registered to the controller, or if system parameters 11 or 12 is set to **HC**.

## SCHEDULING PROGRAMS

In this menu one of thirteen different scheduling programs can be selected for operating the system while in Automatic mode. The programs switch the system between Comfort and ECO mode.

There are nine preset scheduling programs (P1 to P9) and four user defined programs (U1 to U4) available to choose from.

### Program P1:

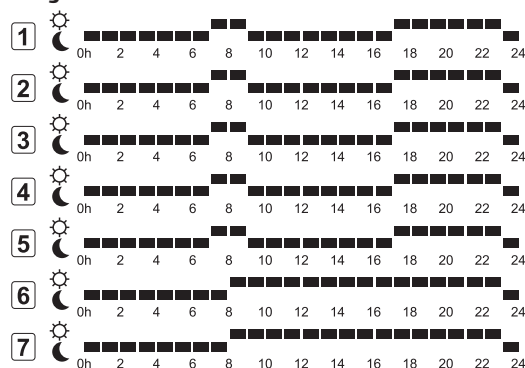

### Program P2:

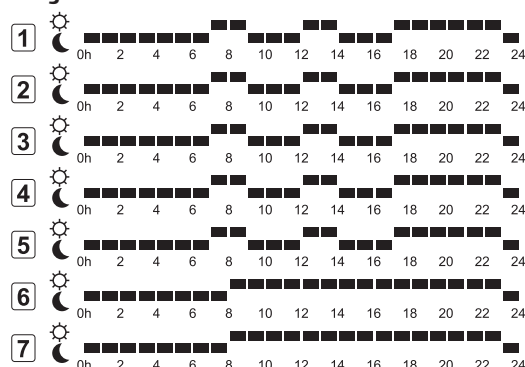

### Program P3:

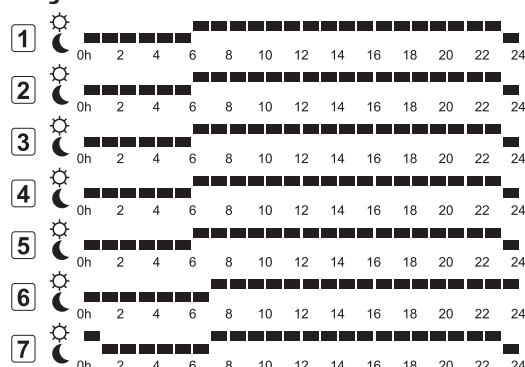

**Program P4:**

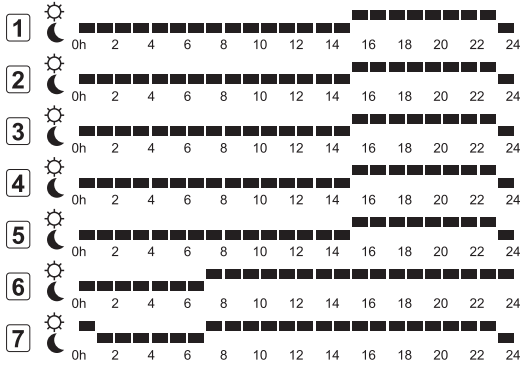

**Program P7:**

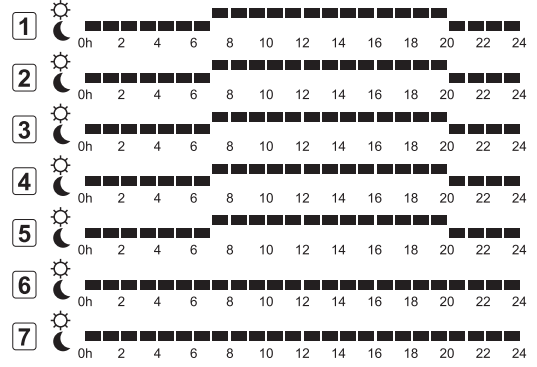

**Program P5:**

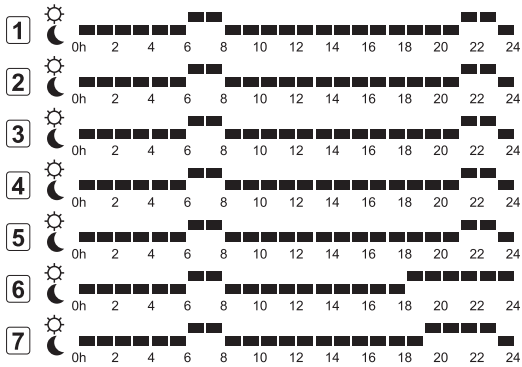

**Program P8:**

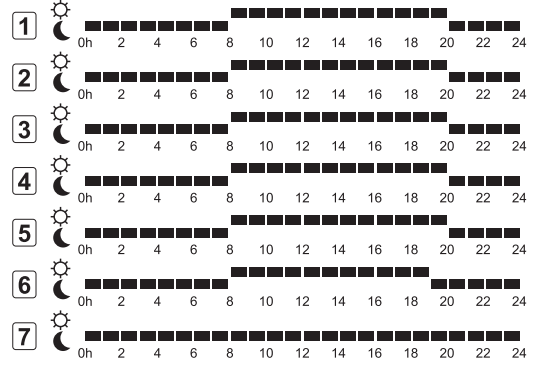

**Program P6:**

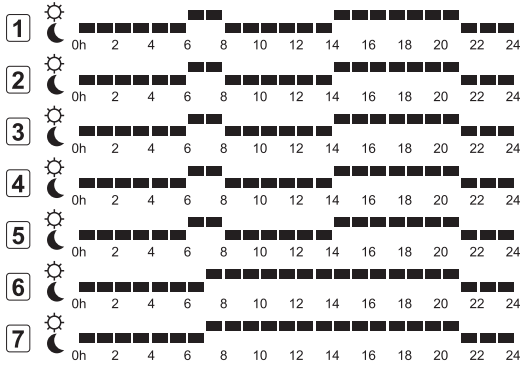

**Program P9:**

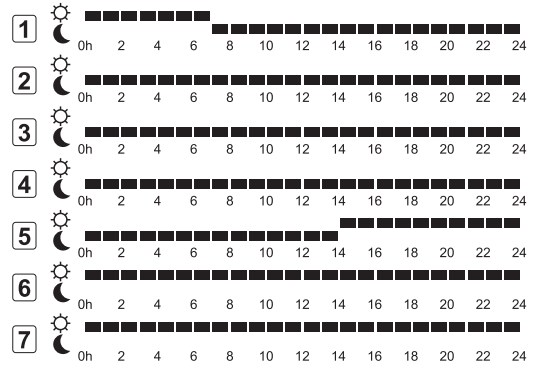

### User defined programs

To edit one of the available user defined scheduling programs using single day programming:

1. Press the > button repeatedly until the scheduling program symbol **P** is marked in the display. One of the available scheduling programs are available.
2. Use buttons -, + or **OK** to enter selection mode. The selected program number starts flashing.
3. Use buttons - or + to select one of the programs named **U1** to **U4**.
4. Press the **OK** button to confirm selection of user defined scheduled program (U1 – U4). The digital clock starts flashing and day 1 is marked.

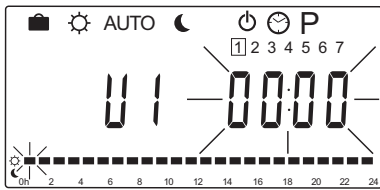

5. Use buttons < or > to select where during the day to start programming. The hours skipped is left unaltered. These buttons can be used to go back to a skipped hour and reprogram it.

6. Use buttons - or + to program the marked hour. Each press of the button confirms the change and moves the marker to the next hour.

+ = ☀ Comfort mode

- = 🌙 ECO mode

The marker at the bottom of the display indicates if the hour is programmed to Comfort or ECO mode.

7. When the day is fully programmed, the software confirms the current days program and moves to the next day. The **OK** button can be used anywhere during the programming of a day to save the setting and go to the next available day.

If starting with a blank program (24/7 Comfort mode) and pressing the **OK** button to go to the next day, the current setting will be copied to the following day.

8. Repeat from step 5 until all available days are programmed.
9. When the seventh day has been saved, use buttons < or > to get back to **Automatic mode**, or wait about 7 seconds for the controller to revert automatically.

## 8.6 System parameter settings

In this menu, settings regarding the operation of the controller is set.



### NOTE!

Some system parameter settings are only accessible during the first 4 hours after power up. This is done to prevent mistakes after installation. If the locked system parameter symbol  is displayed, the power to the controller has to be disconnected and reconnected again to modify these parameters. No settings are lost when disconnecting, or after a power failure.

The settings available while in run mode is always accessible for change, and will not be locked.



### NOTE!

If no button on the controller is pressed for about 4 minutes, the software exits to run mode.

### To enter system parameter settings:

1. Press and hold the **OK** button for about 10 seconds.
2. The settings icon is displayed in the top left hand corner of the display, and the text **Hot type, Cld type**, or **rEv type** (depending of current operating mode) is displayed.
3. Use buttons **<** or **>** to locate a parameter (see list below) and press **OK**.

Some of these parameters require other parameters to activate them.

4. Use buttons **-** or **+** to change parameter settings.

Menu	Display	Description
0	<b>type</b>	Type of installation (heating and/or cooling)
1	<b>Cur</b>	Heating curve <i>See page 58 for more information and a diagram</i>
2	<b>Hi</b>	Maximum supply temperature (heating mode)
3	<b>Lo</b>	Minimum supply temperature (heating mode)
1	<b>Cur</b>	Cooling curve <i>See page 59 for more information and a diagram</i>
2	<b>Hi</b>	Maximum supply temperature (cooling mode)
3	<b>Lo</b>	Minimum supply temperature (cooling mode)
4	<b>InSt</b>	Type of system (hydraulic installation)

Menu	Display	Description
5*	<b>th</b>	Thermostat selection (installed/wireless/etc, <i>see the registration instruction on pages 41 – 42</i> )
6	<b>tHty</b>	Not used by Move
7**	<b>BGAP</b>	Boost function if the difference between the supply and return temperature is too much
8*	<b>trF1</b>	Wireless thermostat 1 configuration ( <i>see the registration instruction on pages 41 – 42</i> )
9*	<b>trF2</b>	Wireless thermostat 2 configuration ( <i>see the registration instruction on pages 41 – 42</i> )  This thermostat controls the operation of circulation pump 2
10*	<b>tr1o</b>	Supply temperature compensation when using a thermostat to speed up the system. Use with caution
11	<b>in1</b>	Wired input 1, select function
12	<b>in2</b>	Wired input 2, select function
13	<b>OUSE</b>	Outdoor sensor selection (installed/wireless*/wired/etc, <i>see the registration instruction on pages 43 – 45</i> )
14	<b>OUt</b>	Outdoor temperature, fixed value if outdoor sensor is not installed
15*	<b>ourF</b>	Wireless outdoor sensor configuration ( <i>see the registration instruction on pages 43 – 44</i> )
16	<b>°C</b>	Display unit
17	<b>00:00</b>	Time unit (AM/PM/24H)
18	<b>GriP</b>	Valve and pump exercise
19	<b>PUMP</b>	Pump start delay after the mixer valve is closed
20	<b>ctrl</b>	Forced control of the actuator
21	<b>PrH</b>	Floor/screed preheating program DIN 1264-4
22	<b>dry</b>	Floor/screed drying program
23	<b>ALL</b>	Factory reset  Press and hold the <b>OK</b> button for about 5 seconds
24	<b>End</b>	Exit system parameter settings

\*) Requires antenna A-155

\*\*) Requires a return sensor

5. Use buttons **<** or **>** to locate parameter **24 (End)** – Exit system parameter settings.
6. Press the **OK** button to exit the system parameter settings.

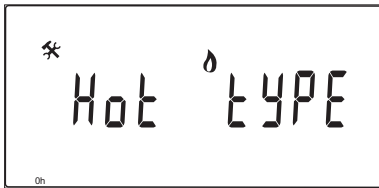
**0 – TYPE OF INSTALLATION**

Select whether the installation is a heating and/or cooling system.

**NOTE!**

When registering a thermostat to the controller (requires antenna A-155), run mode changes parameter **0 (type)** to **rEv**, regardless of previous setting. Heating/cooling is then controlled by the thermostat, or the integrated system.

**To change this setting:**

1. Use buttons - or + to toggle between **Hot**, **CLd** and **rEv**.

**Hot** (Default) Heating system only

**CLd** Cooling system only

**rEv** Heating and cooling system

2. Press **OK** to confirm the change and return to the system parameter settings.

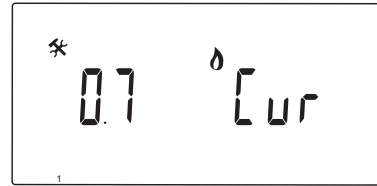
**1 – HEATING CURVE**

Set the heating curve of the system.

The heating curve is used to calculate the supply temperature to the heating system, while in heating mode. See diagram below.

Supply temperature

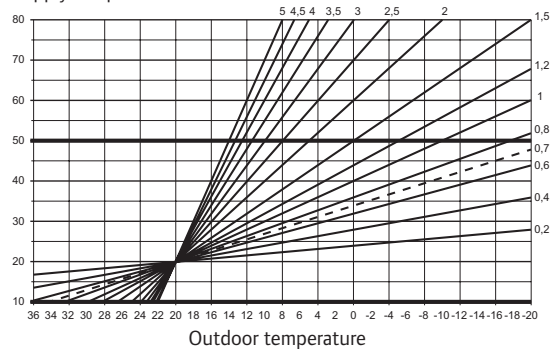
**To change this setting:**

1. Use buttons - or + to change the parameter.

*Default: 0.7*

*Setting range: 0.1 – 5, 0.1 increments*

2. Press **OK** to confirm the change and return to the system parameter settings.

**2 – MAXIMUM SUPPLY TEMPERATURE (HEATING)**

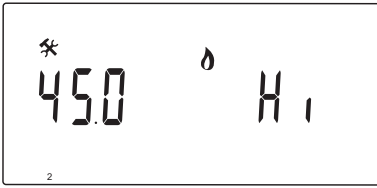

Set a maximum supply temperature limitation, while in heating mode.

**To change this setting:**

1. Use buttons - or + to change the parameter.  
*Default: 45.0 °C*  
*Setting range: (Lo + 5.0) – 100.0 °C, 1.0 °C increments*
2. Press **OK** to confirm the change and return to the system parameter settings.

**NOTE!** This parameter cannot be set lower than the set value in parameter menu **3 – Minimum supply temperature (heating)**.

**3 – MINIMUM SUPPLY TEMPERATURE (HEATING)**

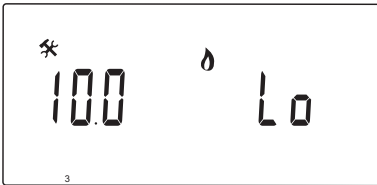

Set a minimum supply temperature limitation, while in heating mode.

**To change this setting:**

1. Use buttons - or + to change the parameter.  
*Default: 10.0 °C*  
*Setting range: 1 – (Hi - 1.0) °C, 1.0 °C increments*
2. Press **OK** to confirm the change and return to the system parameter settings.

**NOTE!** This parameter cannot be set higher than the set value in parameter menu **2 – Maximum supply temperature (heating)**.

**1 – COOLING CURVE**

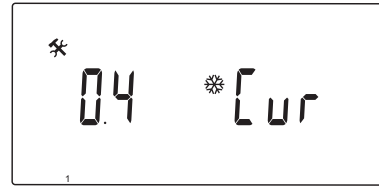

Set the cooling curve of the system.

The cooling curve is used to calculate the supply temperature to the cooling system, while in cooling mode. See diagram below.

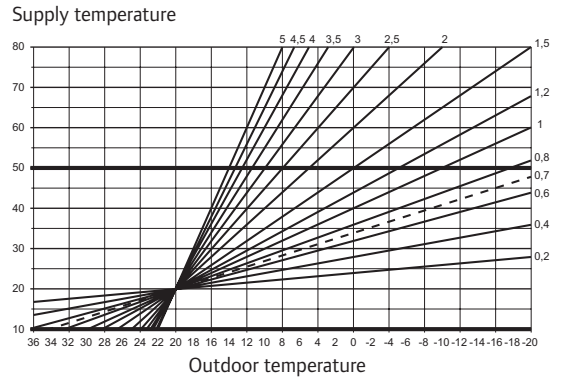

**To change this setting:**

1. Use buttons - or + to change the parameter.  
*Default: 0.4*  
*Setting range: 0.1 – 5, 0.1 increments*
2. Press **OK** to confirm the change and return to the system parameter settings.

## 2 – MAXIMUM SUPPLY TEMPERATURE (COOLING)

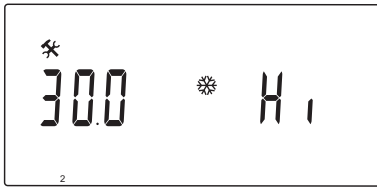

Set a maximum supply temperature limitation, while in cooling mode.

### To change this setting:

- Use buttons - or + to change the parameter.  
*Default: 30.0 °C*  
*Setting range: (Lo + 5.0) – 100.0 °C, 1.0 °C increments*
- Press **OK** to confirm the change and return to the system parameter settings.



#### NOTE!

This parameter cannot be set lower than the set value in parameter menu **3 – Minimum supply temperature (cooling)**.

## 3 – MINIMUM SUPPLY TEMPERATURE (COOLING)

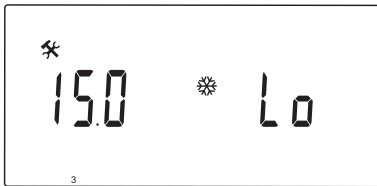

Set a minimum supply temperature limitation, while in cooling mode.

### To change this setting:

- Use buttons - or + to change the parameter.  
*Default: 15.0 °C*  
*Setting range: 1 – (Hi - 1.0) °C, 1.0 °C increments*
- Press **OK** to confirm the change and return to the system parameter settings.



#### NOTE!

This parameter cannot be set higher than the set value in parameter menu **2 – Maximum supply temperature (cooling)**.

## 4 – TYPE OF SYSTEM

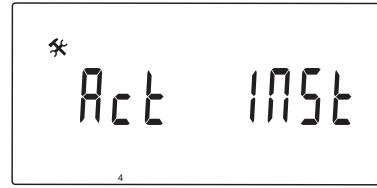

Select the type of hydraulic installation used in the system.

### To change this setting:

- Use buttons - or + to change the parameter.

**Act** (Default) Installation with a mixer valve connected to the ACTUATOR terminal. The COLD terminal will manage a 3-way On/Off valve for switching between heating and cooling.

**SEP** Installation with separate heating and cooling systems. A boiler can be connected to the HEAT terminal and a chiller can be connected to the COLD terminal.

**2P.1** Installation using two circulation pump circuits, one for underfloor heating/cooling using the P1 terminal, and one for panel heaters using the P2/COLD terminal. The second pump (panel heaters) is stopped when in cooling mode to keep cold water out of the panel heater.

**2P.2** Installation using two circulation pump circuits, one for underfloor heating/cooling using the P1 terminal, and one for a fan coil circuit using the P2/COLD terminal.

- Press **OK** to confirm the change and return to the system parameter settings.



## 5 – THERMOSTAT SELECTION

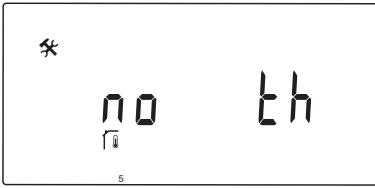

This parameter requires antenna A-155 and a wireless thermostat.

Select if a thermostat is used in the system, and how it is connected.



### CAUTION!

Do not attempt to connect Uponor Smatrix Base thermostats to the controller. They are not suited for each other, and they may get damaged.

### To change this setting:

- Use buttons - or + to toggle between **no**, **YES** and **rF**.
  - no** (Default) Installation without thermostat
  - YES** Installation with wired thermostat (not used in a Move system)
  - rF** Installation with wireless thermostat
- Press **OK** to confirm the change and return to the system parameter settings.

## 6 – WIRED THERMOSTAT CONFIGURATION

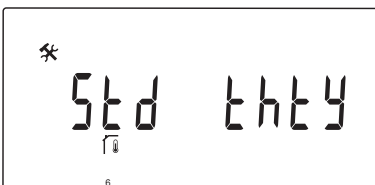

This parameter is only available if parameter 5 – Thermostat selection is set to YES, and is not used by a Move system.

## 7 – BOOST FUNCTION

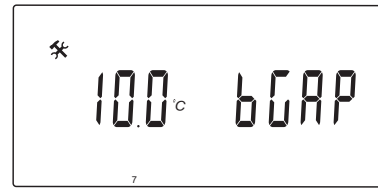

This parameter is only available if a return sensor is installed, and parameter 5 – Thermostat selection is set to YES or no.

Set a maximum difference between the supply and return temperature, for when to activate the boost function.

If the difference between the supply and return temperature is higher than the set value, the function activates.

When activated, the boost function increases (heating mode) or reduces (cooling mode) the calculated supply temperature by 20%.

The boost function deactivates when the difference is at the same temperature or lower than set boost value.

Press the **OK** button to view the current return sensor value.

### Example:

Calculated supply temperature = 40 °C

Current return temperature = 29 °C

Boost value = 10 °C

Difference: 40 - 29 °C = 11 °C

The difference is higher than the set boost value (11 > 10), which activates the function and increases the calculated supply temperature to 48 °C.

### To change this setting:

- Use buttons - or + to change the parameter.
  - Default: 10.0 °C
  - Setting range: 10.0 – 20.0 °C, 0.1 °C increments
- Press **OK** to confirm the change and return to the system parameter settings.

## 8 – WIRELESS THERMOSTAT 1 CONFIGURATION

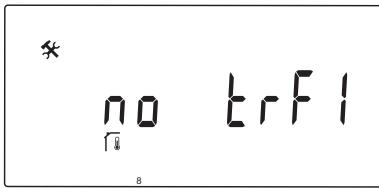

This parameter is only available if parameter 5 – Thermostat selection is set to rF.

Register a wireless thermostat to the controller.



### NOTE!

When registering a thermostat to the controller (requires antenna A-155), run mode changes parameter **0 (type)** to **rEv**, regardless of previous setting. Heating/cooling is then controlled by the thermostat, or the integrated system.

### To register a thermostat:

1. Use buttons - or + to change the parameter to **INI**. The controller is now set in wireless registration mode.

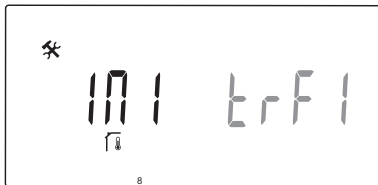

2. Register the thermostat.
3. When the current room temperature is shown, press the **OK** button to confirm the registration.

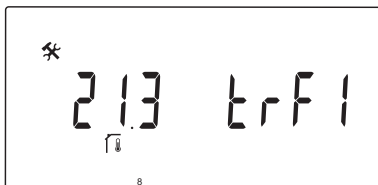

See section 6.10 Register a thermostat to the controller for more information.

## 9 – WIRELESS THERMOSTAT 2 CONFIGURATION

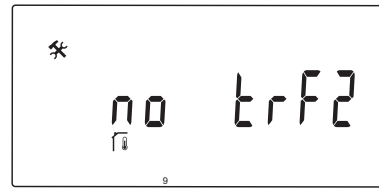

This parameter is only available if parameter 5 – Thermostat selection is set to rF, and parameter 4 – Type of system is set to 2P.1 or 2P.2.

Register a second wireless thermostat to the controller, for use in systems with two circulation pumps (panel heaters or fan coils).



### NOTE!

When registering a thermostat to the controller (requires antenna A-155), run mode changes parameter **0 (type)** to **rEv**, regardless of previous setting. Heating/cooling is then controlled by the thermostat, or the integrated system.

### To register a thermostat:

1. Use buttons - or + to change the parameter to **INI**. The controller is now set in wireless registration mode.

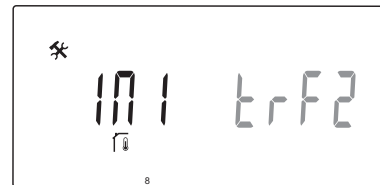

2. Register the thermostat.
3. When the current room temperature is shown, press the **OK** button to confirm the registration.

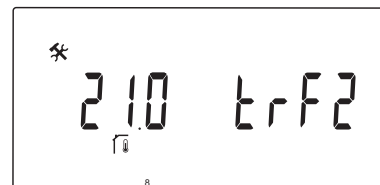

See section 6.10 Register a thermostat to the controller for more information.

## 10 – SUPPLY TEMPERATURE COMPENSATION

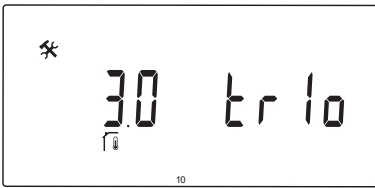

This parameter is only available if parameter 5 – Thermostat selection is set to rF, and a thermostat is registered to the controller (requires antenna A-155).

Set a value for supply temperature compensation, while using a wireless thermostat.

The difference between the room setpoint and current room temperature is multiplied with the set value to create an offset. The offset is then added to create a new calculated supply temperature, and making the system react quicker to a change of indoor temperature.

### Example:

Calculated supply temperature = 35 °C

Thermostat setpoint = 21 °C

Current room temperature = 19 °C

Set value = 3 °C

New calculated value:  $35 + 3 \cdot (21 - 19) = 41$  °C

The calculated supply temperature is added by 6 °C to 41 °C.

### To change this setting:

1. Use buttons - or + to change the parameter.  
Default: 0.1 °C  
Setting range: 0.1 – 9.9 °C, 0.1 °C increments
2. Press **OK** to confirm the change and return to the system parameter settings.



#### CAUTION!

Setting the value to high, might make the system unstable, creating large fluctuations in indoor temperature and increasing the energy need from the heat source/cooling unit.



#### CAUTION!

Setting the value to low, will make the system react slowly to changes in the indoor temperature, keeping the system cool or hot for an excessive amount of time. Too high supply temperatures might lead to damages to wooden floors.



#### NOTE!

The pump will be switched off when room temperature is 1 °C above the thermostat setpoint.

## 11 – WIRED INPUT 1 SELECTION

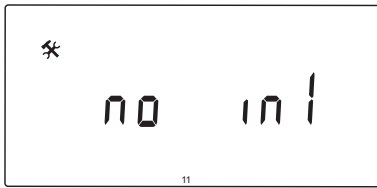

Set if optional wired input 1 (terminal block In1) is used, and which function it has.

### To change this setting:

- Use buttons - or + to change the parameter.
  - no** (Default) Terminal block In1 is not used.
  - th1** – A wired thermostat is connected.  
Requires parameter 5 – Thermostat selection set to **YES**.
  - Aqu** An immersion thermostat/aquastat is connected. If the thermostat setpoint is reached (contact open), circulation pump 1 is stopped and the actuator closes to avoid cold water circulation. Generally used if a wood boiler is present in the system.
  - HC** A heating/cooling switch is connected between In1 and 2, or a phase signal to In1.  
No signal (open circuit) = Heating  
Phase signal (closed circuit) = Cooling  
Requires the following parameter settings:  
Parameter 0 – Type of installation = **rEv**  
Parameters 8 – Wireless thermostat 1 configuration = **no**  
Parameters 9 – Wireless thermostat 2 configuration = **no**
  - C\_b** A pump signal (demand) from a connection box (i.e. a Wave controller) is connected between In1 and 2, or a phase signal to In1. The signal controls the operation of circulation pump 1.  
No signal (open circuit) = Circulation pump OFF  
Phase signal (closed circuit) = Circulation pump ON
- Press **OK** to confirm the change and return to the system parameter settings.



### NOTE!

If the circulation pump has been stopped by an immersion thermostat/aquastat, the controller keeps the HEAT output active.



### NOTE!

If the controller is in cooling mode and the storage tank is filled with cold water, the Aqu-function is automatically disabled to avoid problems.



### NOTE!

A demand to start the circulation pump, and the parameter set to **C\_b**, will activate the HEAT output.



### NOTE!

If the Move system is integrated to an Uponor Smatrix Wave system (requires antenna A-155 and a wireless thermostat), energy saving can be ensured by using the pump logic of an electric connecting box, to switch the pump on or off.

## 12 – WIRED INPUT 2 SELECTION

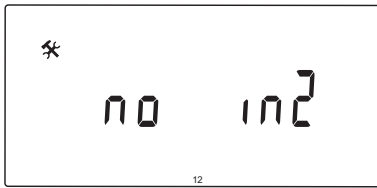

Set if optional wired input 2 (terminal block In2) is used, and which function it has.

### To change this setting:

- Use buttons - or + to change the parameter.
  - no** (Default) Terminal block In2 is not used.
  - th2** – A wired thermostat is connected.  
Requires parameter 5 – Thermostat selection set to **YES**, and parameter 4 – Type of system is set to **2P.1** or **2P.2**.
  - Aqu** An immersion thermostat/aquastat is connected. If parameter 4 – Type of system is set to **Act** or **SEP** and the thermostat setpoint is reached (contact open), circulation pump 1 is stopped and the actuator closes to avoid cold water circulation. If parameter 4 – Type of system is set to **2P.1** or **2P.2** and the thermostat setpoint is reached (contact open), circulation pump 2 is stopped. Generally used if a wood boiler is present in the system.
  - HC** A heating/cooling switch is connected between In2 and 2, or a phase signal to In2.  
No signal (open circuit) = Heating  
Phase signal (closed circuit) = Cooling  
Requires the following parameter settings:  
Parameter 0 – Type of installation = **rEv**  
Parameters 8 – Wireless thermostat 1 configuration = **no**  
Parameters 9 – Wireless thermostat 2 configuration = **no**
  - C\_b** A pump signal (demand) from a connection box (i.e. a Wave controller) is connected between In2 and 2, or a phase signal to In2. The signal controls the operation of circulation pump 1.  
No signal (open circuit) = Circulation pump OFF  
Phase signal (closed circuit) = Circulation pump ON
- Press **OK** to confirm the change and return to the system parameter settings.



### NOTE!

If the circulation pump has been stopped by an immersion thermostat/aquastat, the controller keeps the HEAT output active.



### NOTE!

If the controller is in cooling mode and the storage tank is filled with cold water, the Aqu-function is automatically disabled to avoid problems.



### NOTE!

A demand to start the circulation pump, and the parameter set to **C\_b**, will activate the HEAT output.



### NOTE!

If the Move system is integrated to an Uponor Smatrix Wave system (requires antenna A-155 and a wireless thermostat), energy saving can be ensured by using the pump logic of an electric connecting box, to switch the pump on or off.

### 13 – OUTDOOR SENSOR SELECTION

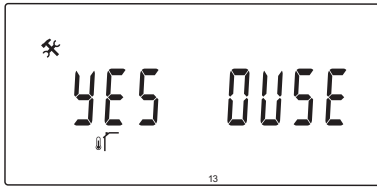

Select if an outdoor temperature sensor is used in the system, and how it is connected.

#### To change this setting:

- Use buttons - or + to toggle between **no**, **YES** and **rF**.
  - YES** (Default) Installation with a wired outdoor sensor
  - no** Installation without an outdoor sensor
  - rF** Installation with a wireless outdoor sensor
- Press **OK** to confirm the change and return to the system parameter settings.

### 14 – OUTDOOR TEMPERATURE, FIXED

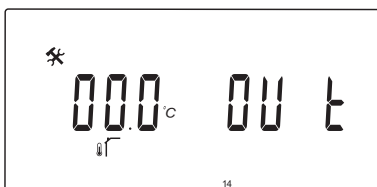

This parameter is only available if parameter 13 – Outdoor sensor selection is set to **no**.

Set a fixed outdoor temperature that is used to calculate the supply temperature, when no outdoor sensor is available.

#### To change this setting:

- Use buttons - or + to change the parameter.
  - Default: 0.0 °C
  - Setting range: -49.0 – 50.0 °C, 0.1 °C increments
- Press **OK** to confirm the change and return to the system parameter settings.

### 15 – WIRELESS OUTDOOR SENSOR CONFIGURATION

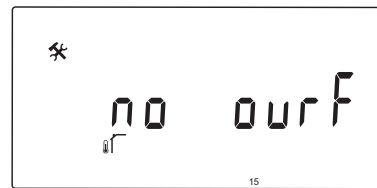

This parameter is only available if parameter 13 – Outdoor sensor selection is set to **rF**.

Register a wireless thermostat to the controller.

#### To register a thermostat:

- Use buttons - or + to change the parameter to **INI**. The controller is now set in wireless registration mode.



- Register the thermostat.
- When the current room temperature is shown, press the **OK** button to confirm the registration.

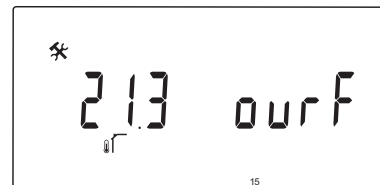

See section 6.10 Register a thermostat to the controller for more information.

## 16 – DISPLAY UNIT

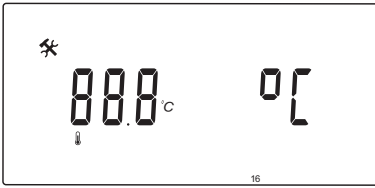

Select the temperature display unit used by the controller.

### To change this setting:

- Use buttons - or + to toggle between °C and °F.
  - °C (Default) degrees Celsius
  - °F degrees Fahrenheit
- Press **OK** to confirm the change and return to the system parameter settings.

## 17 – TIME UNIT

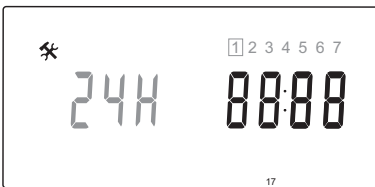

Select the time display unit used by the controller.



### NOTE!

Do not attempt to set day and time in this menu. It is not allowed, and the setting will not be saved.

### To change this setting:

- Use buttons - or + to toggle between **24H** and **12H**.
  - 24H** (Default) Use a 24 h display of time.
  - 12H** Use a 12 h display of time, using AM and PM icons to indicate time of day.
- Press **OK** to confirm the change and return to the system parameter settings.

## 18 – VALVE AND PUMP EXERCISE

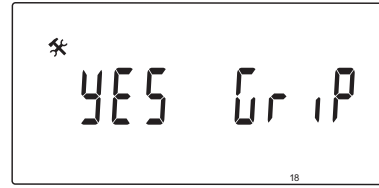

Select if the valve and pump exercise function is active.

The function is activated at noon (12:00) if the valve and pump has not been operated for a period of 24 hours.

**12:00** The pump is activated for 1 minute.

**12:01** The actuator opens, operation takes 2 minutes.

**12:03** The actuator closes, operation takes 2 minutes.

### To change this setting:

- Use buttons - or + to toggle between **YES** and **no**.
  - YES** (Default) Valve and pump exercise is active.
  - no** Valve and pump exercise is inactive.
- Press **OK** to confirm the change and return to the system parameter settings.

## 19 – PUMP DELAY



Set a time for how long the circulation pump is to be shut off after the mixer valve is closed.

After each set interval, the circulation pump restarts to maintain the supply flow and temperature.

### To change this setting:

- Use buttons - or + to change the parameter.
  - Default: --- (continuous operation)
  - Setting range: ---, 0 – 60 minutes
- Press **OK** to confirm the change and return to the system parameter settings.

## 20 – FORCED CONTROL

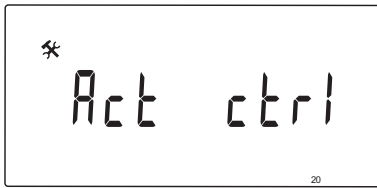

Select this parameter to forced control of the actuator.



### NOTE!

If a button is pressed, the actuator stops for 15 seconds before continuing with its given task.

### To force control of the actuator:

- Use buttons - or + to open or close the actuator.
  - + = **OPEN**, the actuator opens.
  - = **CLOS**, the actuator closes.
- Use buttons < or > to stop (**STOP** is displayed) the actuator. The actuator will hold its current position until buttons - or + are pressed again, or if forced mode is cancelled.
- Use buttons < or >, when stopped, to exit forced mode and return to the system parameter settings.

## 21 – FLOOR/SCREED PREHEATING PROGRAM DIN 1264-4



Select this function to activate a floor/screed preheating program. The preheating program is used to prevent damage of newly built underfloor heating systems, according to DIN 1264-4.

### To change this setting:

- Use buttons - or + to change the parameter.
  - 0dry** (Default) The function is not active.
  - 7dry** The function is active.
- Press **OK** to confirm the change and return to the system parameter settings.
- The program runs automatically according to the following schedule:
  - Day 1 – 3: The calculated supply temperature is set to 25 °C.
  - Day 4 – 7: The calculated supply temperature is set to the maximum heating limit (parameter 2).



### NOTE!

Contact the supplier of the material for the house foundation, to get a maximum allowed temperature. This parameter is set in parameter 2 – Maximum supply temperature.

When the program is running, the remaining days is displayed as shown in the following illustration.

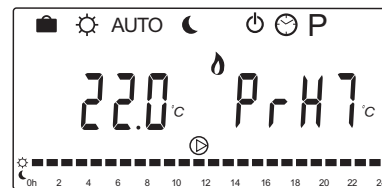

### To stop the preheating program:

- Locate the parameter in the system parameter settings menu.
- Press the **OK** button twice until **0day** is displayed.
- Press **OK** to confirm the change and return to the system parameter settings.



## 22 – FLOOR/SCREED DRYING PROGRAM

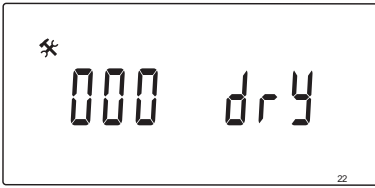

Select this function to activate a floor/screed drying program. The drying program is used to prevent damage of newly built underfloor heating systems in cold houses.

### To change this setting:

- Use buttons - or + to change the parameter.  
*Default: 13 days*  
*Setting range: 7 – 60 days*
- Press **OK** to confirm the change and return to the system parameter settings.
- The program runs automatically according to the following schedule:

X = The set number of days.

Day 1 – 3: The calculated supply temperature is set to 25 °C.

Day 4 – (X-3) : The calculated supply temperature is set to the maximum heating limit (parameter 2).

Days (X-3) – X: The calculated supply temperature is set to the minimum heating limit (parameter 3).



### NOTE!

Contact the supplier of the house foundation to get a maximum allowed temperature. This parameter is set in parameter 2 – Maximum supply temperature.

When the program is running, the remaining days are displayed on the display as shown in the following illustration.



### To stop the drying program:

- Locate the parameter in the system parameter settings menu.
- Press the **OK** button twice until **0 dry** is displayed.
- Press **OK** to confirm the change and return to the system parameter settings.

## 23 – FACTORY RESET

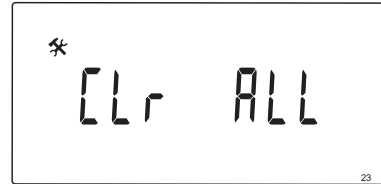

Select this function to reset all controller parameters to default values.



### NOTE!

This function resets all controller parameters to default values.

This includes registration data for wireless thermostats and sensors, and user customised scheduling programs.

### To initiate a factory reset:

- Press and hold the **OK** button until the display goes blank (takes about 5 seconds).
- The controller restarts and the software version is shown before entering **Auto** mode.

## 24 – EXIT SYSTEM PARAMETER SETTINGS

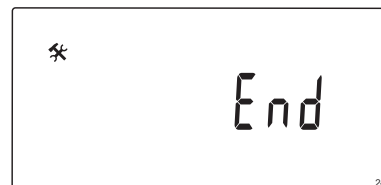

Press the **OK** button to exit the system parameters menu.

## 9 Operate Uponor Smatrix Wave analogue thermostats

Two types of thermostats, both analogue and digital, can be used in an Uponor Smatrix Move system.



### CAUTION!

Antenna A-155 must be installed when using a wireless thermostat.

### Analogue thermostats:



Uponor Smatrix Wave T-163  
(public thermostat T-163)

The analogue thermostat is controlled by adjusting a potentiometer on its back.

### 9.1 Thermostat layout

#### PUBLIC THERMOSTAT T-163

During normal operation a discreet LED on back of the thermostat is lit for about 60 seconds if there is a demand for heating or cooling.

The illustration below shows the parts of the thermostat.

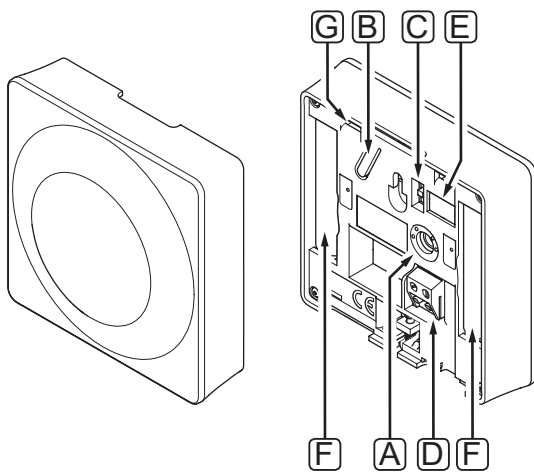

Item	Description
A	Setpoint temperature potentiometer
B	Registration button
C	Disable timer switch (not used in an Uponor Smatrix Move system)
D	Terminal for external sensor (non-polarised)
E	Configuration DIP switches
F	Batteries
G	Heating/cooling demand LED

### 9.2 Adjust temperature

The temperature is changed by adjusting the setpoint on the thermostat to a value between 5 and 35 °C.

#### PUBLIC THERMOSTAT T-163

The illustration below shows how to adjust the thermostat temperature setpoint.

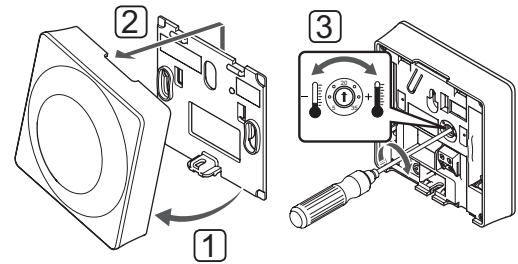

To change the thermostat temperature setpoint:

1. Angle the thermostat from the bracket.
2. Remove it from the wall.
3. Set the desired temperature using the potentiometer.
4. Put the thermostat back on the wall.

### 9.3 Replace batteries

Replace the batteries of the thermostat when the LED flashes twice during a heating or cooling demand.

The thermostat will perform a self test, for about 10 seconds, when the batteries have been inserted. The system will be blocked for input and the thermostat LED flashes during this period.

The illustration below shows how to change batteries.

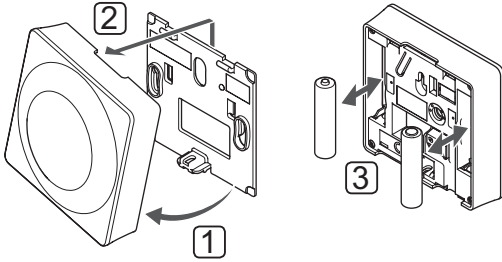

1. Angle the thermostat from the bracket.
2. Remove it from the wall.
3. Replace batteries.

### 9.4 Factory reset

Factory reset sets all parameter values to default settings.



#### NOTE!

Do not factory reset the thermostat if not absolutely needed.



#### NOTE!

A factory reset removes the registration data from the thermostat.

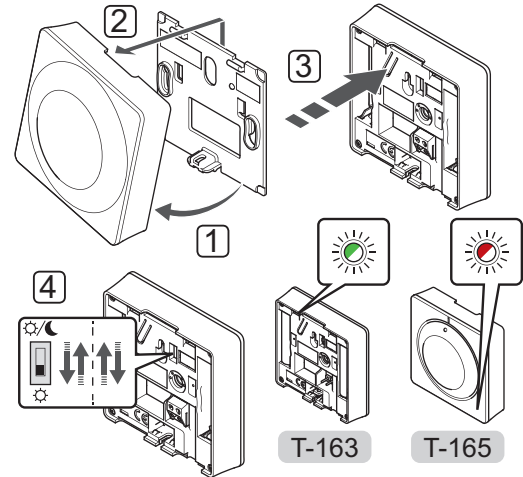

To factory reset an analogue thermostat:

1. Angle the thermostat from the bracket.
2. Remove it from the wall.
3. Gently press and hold the registration button on the thermostat, release when the demand LED starts flashing.
4. Change the Disable timer switch twice, regardless of starting position.
5. The thermostat is now reset to factory default.

# 10 Operate Uponor Smatrix Wave digital thermostats

Two types of thermostats, both analogue and digital, can be used in an Uponor Smatrix Move system.

The digital thermostats have a display relaying information to the user and buttons for control.



### CAUTION!

Antenna A-155 must be installed when using a wireless thermostat.

#### Digital thermostats:



Uponor Smatrix Wave T-169  
(digital thermostat with RH T-169)



Uponor Smatrix Wave T-168  
(programmable thermostat with RH T-168)  
Uponor Smatrix Wave T-166  
(digital thermostat T-166)

## 10.1 Thermostat layout

### THERMOSTAT T-169

The illustration below shows the parts of the thermostat.

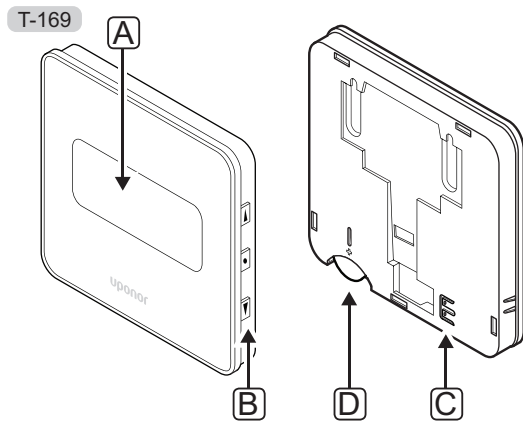

Item	Description
A	Display
B	Buttons
C	Terminal for external sensor (non-polarised)
D	Battery

### THERMOSTATS T-166 AND T-168

The illustration below shows the parts of the thermostat.

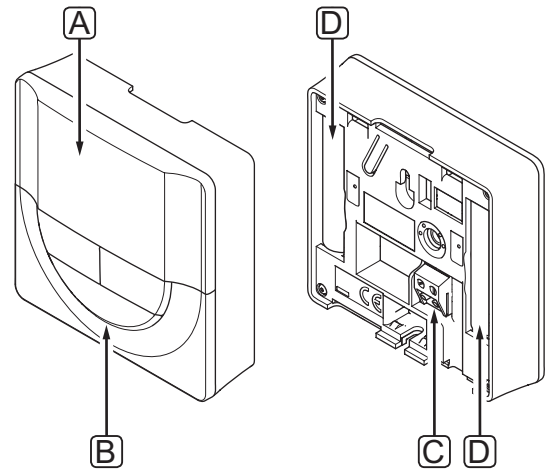

Item	Description
A	Display
B	Buttons
C	Terminal for external sensor (non-polarised)
D	Batteries

## 10.2 Display layout

### THERMOSTAT T-169

The figures shows different display screens and the different symbols that can be shown.

#### Run mode (default screen)

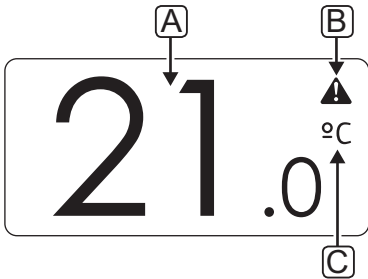

Pos.	Icon	Description
A	21.0	Temperature reading using a - or + sign, two digital characters, a decimal point and a character showing either 0 or 5
B	! (alarm symbol)	Alarm symbol
C	°C / °F	Temperature unit

#### Change setpoint

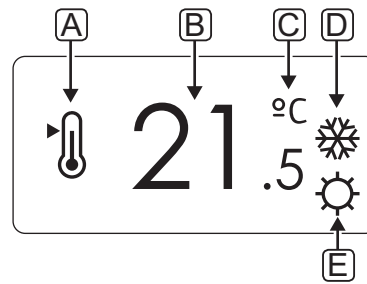

Pos.	Icon	Description
A	Thermometer icon	Change setpoint mode
B	21.5	Temperature setpoint, using a - or + sign, two digital characters, a decimal point and a character showing either 0 or 5
C	°C / °F	Temperature unit
D	Heating demand (wavy lines) / Cooling demand (snowflake)	Heating demand / Cooling demand
E	Sun icon / Moon icon	Comfort mode / ECO mode

Alarms

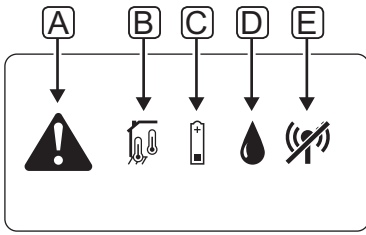

Pos.	Icon	Description
A		Alarm mode
B		Faulty indoor temperature sensor
		Faulty floor temperature sensor
		Faulty remote temperature sensor
		Faulty outdoor temperature sensor
C		Low battery indicator
D		Relative humidity limit reached
E		Communication fault indicator

Control mode

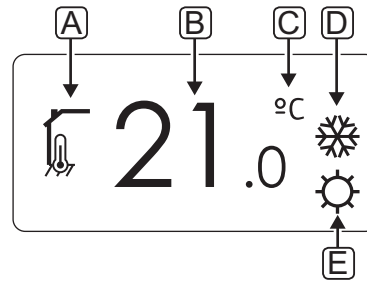

Pos.	Icon	Description
A		Current control mode Indoor temperature indicator
		Current control mode Indoor temperature with floor temperature limitation indicator
		Current control mode Remote sensor temperature indicator
		Current control mode Outdoor temperature indicator
	B	21.0
C	°C	Temperature unit
	°F	
D		Heating demand
		Cooling demand
E		Comfort mode
		ECO mode
		Holiday mode

RELATIVE HUMIDITY

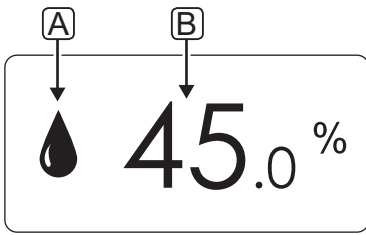





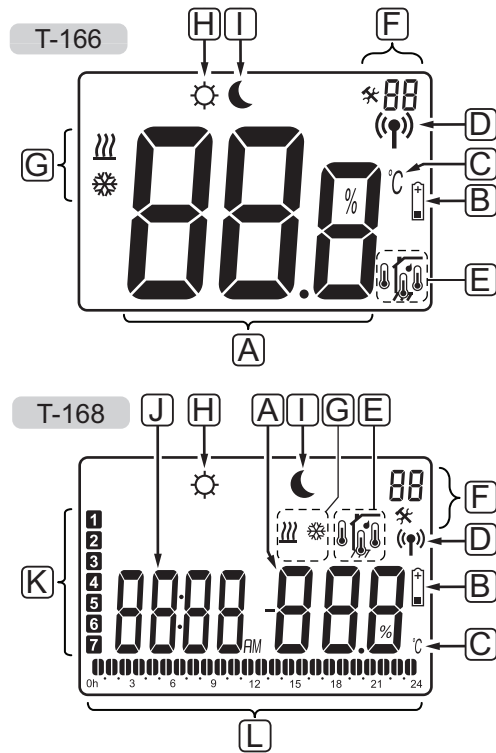

Pos.	Icon	Description
A		Relative humidity level
B	45.0	Relative humidity reading using two digital characters. Indicated with a “%” character

THERMOSTATS T-166 AND T-168

The figure below shows all possible symbols and characters that can be shown on the display:



Pos.	Icon	Description
A	888	T-166 only Message field using three alphanumerical characters
	T-166 88.8	Temperature reading using a - or + sign, two digital characters, a decimal point and a character showing either 0 or 5
	T-168 88.8	Temperature reading using a - or + sign, two digital characters, a decimal point and a character showing either 0 or 5
	T-168 88%	Relative humidity reading using two digital characters. Indicated with a “%” character
B		Low battery indicator
C	°C °F	Temperature unit, shown when the character group A shows a temperature
D		Communication indicator
E		Indoor temperature indicator Remote sensor temperature indicator (RS mode) The text <b>Err</b> and a flashing sensor icon indicates a faulty sensor
		Indoor temperature with floor temperature limitation indicator The text <b>Err</b> and a flashing floor sensor icon indicates a faulty sensor
		Floor temperature indicator The text <b>Err</b> and a flashing floor sensor icon indicates a faulty sensor
		Outdoor temperature indicator The text <b>Err</b> and a flashing outdoor sensor icon indicates a faulty sensor
		T-168 only Relative humidity limit reached
F		Settings menu
	88	Settings menu number
G		Heating demand
		Cooling demand
H		Comfort mode
I		ECO mode

Pos.	Icon	Description
J		<i>T-168 only</i> Digital clock
		<i>T-168 only</i> Parameter name in settings menu
	 	<i>T-168 only</i> Indicator showing AM or PM when the thermostat is set to 12 h mode  No indication when the thermostat is set to 24 h mode
K		<i>T-168 only</i> Weekday selected/activated 1 = Monday 7 = Sunday
L		<i>T-168 only</i> Time selected or scheduled hour indicators, for Comfort mode, between 0:00 and 24:00  Half = 30 minutes Full = 1 hour

### 10.3 Operating buttons

The figure below shows buttons used to operate the digital thermostats.

T-169

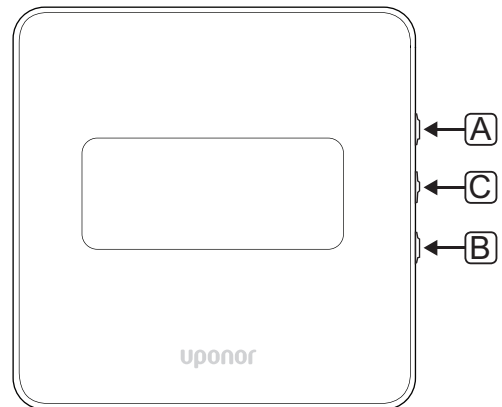

T-166  
T-168

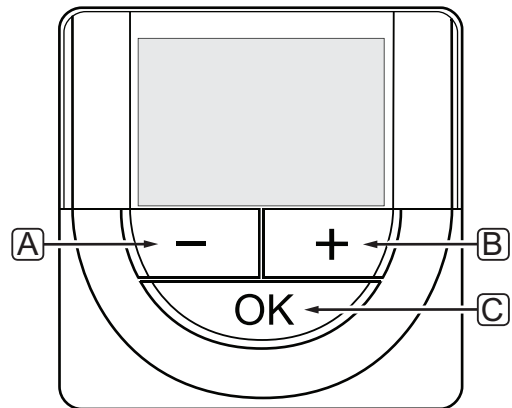

Pos.	Description
A	The - and + buttons are used to:
B	<ul style="list-style-type: none"> <li>Adjust setpoint temperature</li> <li>Modify parameters in the settings menus</li> </ul>
C	The OK button is used to: <ul style="list-style-type: none"> <li>Toggle between current status data, and values of available sensors connected to the thermostat</li> <li>Enter and exit the settings menu</li> <li>Confirm a setting</li> </ul>



## 10.4 Start up

When starting up, the software version is shown in the display for about three seconds. Then the thermostat enters run mode.

The first time the thermostat is started, or after a factory reset, the software requires the time and date to be set (T-168 only).

### SOFTWARE VERSION

Current software version is displayed when the thermostat is powered on.

Examples:

T-169



T-166



T-168



### SET TIME AND DATE (T-168 ONLY)

When starting the thermostat for the first time, after a factory reset, or after it has been left without batteries too long, the software requires the time and date to be set.

Use buttons - or + to change the value, press the **OK** button to set the value and move to the next editable value.

#### **!** NOTE!

If no button is pressed for about 8 seconds, the current values will be saved and the software exits to run mode.

1. Set hours.



2. Set minutes.



3. Set 12 h or 24 h display of time.



4. Set day of the week (1 = Monday, 7 = Sunday).



5. Set day of the month.



6. Set month.



7. Set year.



8. Press **OK** to return to run mode.

Date and time can also be set in the settings menu.

See section 10.9 Settings for more information.

## 10.5 Adjust temperature

The temperature is changed by adjusting the setpoint on the thermostat.

Use the buttons on the thermostat to adjust the temperature. The display will light up when pressing a button. It shuts off after about 10 seconds of inactivity.

The illustration below shows how to adjust the thermostat temperature setpoint.

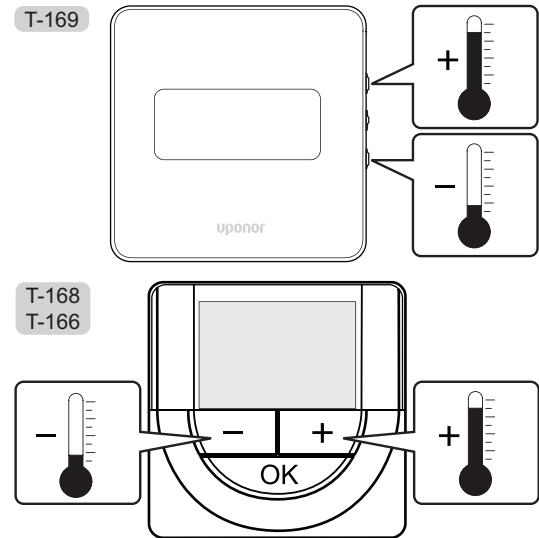

To adjust the thermostat temperature setpoint of the current control mode:

1. Press the - or + (T-169 = ▼ or ▲) button once.

The screen shows the current setpoint flashing.

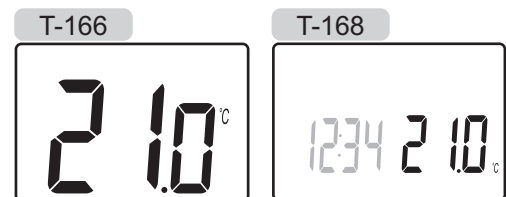
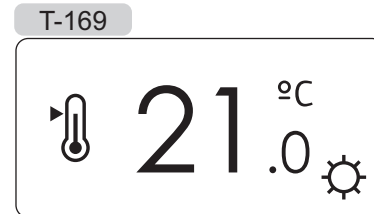

2. Press the - or + (T-169 = ▼ or ▲) button repeatedly to adjust the setpoint temperature. It will change with increments of 0.5.

When the new setpoint is set, the screen returns to run mode after a few seconds, showing the room temperature.

## 10.6 Run mode





During normal operation the thermostat is in run mode.

While in run mode the display shows specific control mode information.

## 10.7 Control mode

The thermostat has four different control modes, set in the settings menu.

Control modes:

T-169	T-166/ T-168	Description
	RT	Room temperature
	RFT	Room temperature with external floor sensor (limitations does not affect the operation of the Move controller, when not integrated to a Wave controller)
	RS	Remote sensor
	RO	Room temperature with remote outdoor sensor

Different types of information can be shown in the display when in a control mode. The digital thermostat T-168 also shows the clock and scheduled program information.

Use the **OK** button to toggle between the information available.

### RT, ROOM TEMPERATURE MODE

1. Room temperature (default)
2. Alarm list (only shown if an alarm is present in a T-169 thermostat)
3. Room temperature, current ECO/Comfort mode, and current heating/cooling demand (T-169 only)
4. Relative humidity (T-168 and T-169 only)

### RFT, ROOM FLOOR TEMPERATURE MODE

1. Room temperature (default)
2. Alarm list (only shown if an alarm is present in a T-169 thermostat)
3. Floor temperature, current ECO/Comfort mode, and current heating/cooling demand (T-169 only)
4. Relative humidity (T-168 and T-169 only)
5. Floor temperature (T-166 and T-168 only)

### RS, REMOTE SENSOR MODE

1. Room temperature (default)
2. Alarm list (only shown if an alarm is present in a T-169 thermostat)
3. Remote sensor, current ECO/Comfort mode, and current heating/cooling demand (T-169 only)
4. Relative humidity (T-168 and T-169 only)

### RO, REMOTE OUTDOOR SENSOR MODE

1. Room temperature (default)
2. Alarm list (only shown if an alarm is present in a T-169 thermostat)
3. Outdoor temperature, current ECO/Comfort mode, and current heating/cooling demand (T-169 only)
4. Relative humidity (T-168 and T-169 only)
5. Outdoor temperature (T-166 and T-168 only)

## 10.8 Change control mode

If an external sensor is connected to the thermostat, a control mode must be chosen to accommodate the extra functionality of the sensor.



### NOTE!

If no button is pressed for about 8 seconds, while in a submenu, the current values will be saved and the software exits to the settings menu. About about 60 seconds later, it exits to run mode.

1. Press and hold the **OK** button until the settings icon and menu numbers is displayed in the top right corner of the display (about 3 seconds).
2. Use buttons - or + (T-169 = ▼ or ▲) to change the numbers to **04** and press **OK**.
3. Current control mode is displayed (RT, RFT, RS or RO).
4. Use buttons - or + (T-169 = ▼ or ▲) to change control mode (see list below) and press **OK**.

T-169	T-166/ T-168	Description
	RT	Room temperature
	RFT	Room temperature with external floor sensor (limitations does not affect the operation of the Move controller, when not integrated to a Wave controller)
	RS	Remote sensor
	RO	Room temperature with remote outdoor sensor

5. Press and hold the **OK** button for about 3 seconds to exit the settings menu.

## 10.9 Settings

In this menu all settings regarding the operation of the thermostat is set.



### NOTE!

If no button is pressed for about 8 seconds, while in a submenu, the current values will be saved and the software exits to the settings menu. About 60 seconds later, it exits to run mode.

To enter the settings menu:

1. Press and hold the **OK** button for about 3 seconds.
2. The settings icon and menu numbers are displayed in the top right corner of the display.
3. Use buttons - or + (T-169 = ▼ or ▲) to change the numbers to locate a submenu (see list below).

**00** = Program (T-168 only)

**02** = Heating/cooling changeover

**03** = ECO mode setback temperature

**04** = Control mode

**05** = High floor temperature limitation

**06** = Low floor temperature limitation

**07** = Cooling allowed

**08** = Display unit

**09** = Climatic controller integration

**10** = Time and date (T-168 only)

**11** = Room temperature calibration

**12** = Invert screen (T-169 only)

4. Press **OK** to enter parameter edit mode.  
T-166 and T-168: the parameter starts flashing.  
T-169: the menu number is underlined.
5. Change parameters in the submenus.
6. Press and hold the **OK** button for about 3 seconds to exit the settings menu.

**00 PROGRAM (T-168 ONLY)**

In this menu, one of seven different scheduling programs for Comfort/ECO mode can be set. Program 1 to 6 is pre-programmed and the 7th is user defined. The scheduled programs show the day split into 30 minute intervals which is set to either Comfort (black marker) or ECO mode (blank marker).

Program Off (default):

Program P1:

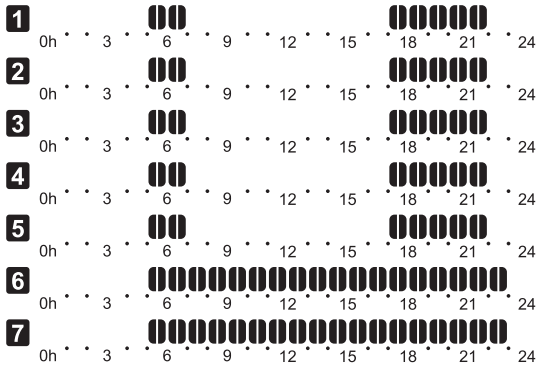

Program P2:

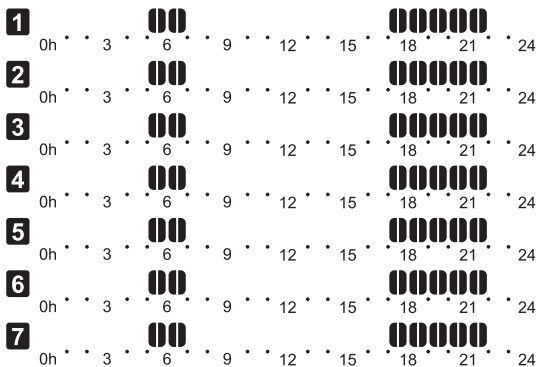

Program P3:

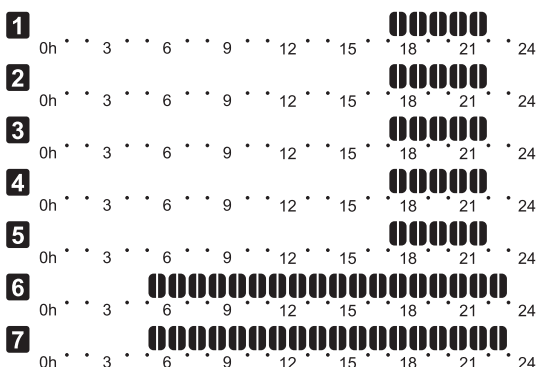

Program P4:

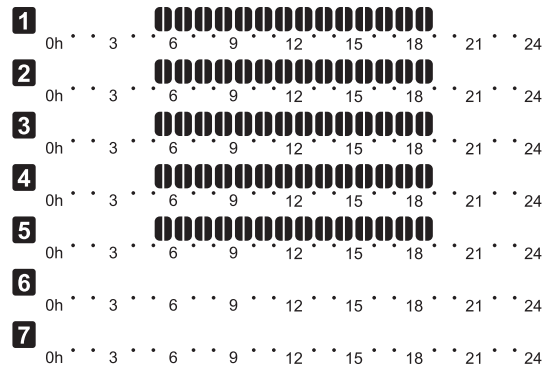

Program P5:

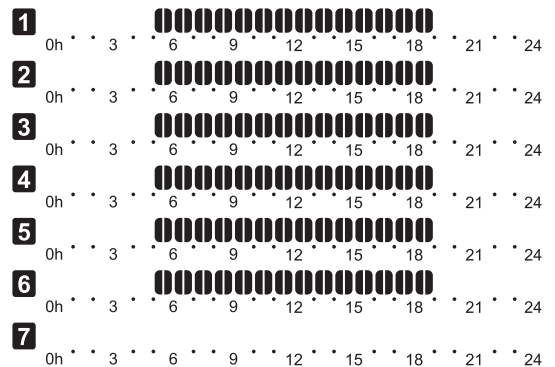

Program P6:

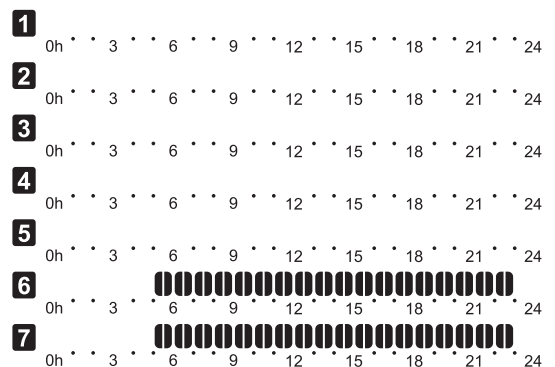

**Select scheduling program**

To select a scheduling program:

1. Press **OK** to enter parameter edit mode.
2. Use buttons - or + to select program.  
Select between: **P1-P6, U** (user defined program) and **Off**.
3. Press **OK** to confirm program selection and return to the settings menu.

### Customise user defined program for a single day

To customise the user defined program:

1. Press **OK** to enter parameter edit mode.
2. Use buttons - or + to select program **U**.
3. Press **OK** to confirm program selection.  
The current day starts flashing.
4. Use buttons - or + to select a day.
5. Press and hold **OK** until **00:00** appears on the display (takes about 2 seconds).
6. Press **OK** to switch the marked interval between Comfort (☀) and ECO mode (☾).
7. Use buttons - or + to move the marker (at the bottom of the display). When moving the marker from one interval to another save the selected mode to that interval.
8. Repeat steps 6 and 7 until the display shows **23:30**.
9. Press + to finalize the current day and the software exits to the settings menu.
10. Repeat from step 1 to customise another day.

### Customise user defined program for a full week

NOTE! This method resets the current user defined program to factory defaults.

To customise the user defined program:



1. Press **OK** to enter parameter edit mode.
2. Use buttons - or + to select program **U**.
3. Press and hold **OK** until day **1** and **00:00** appears on the display.
6. Press **OK** to switch the marked interval between Comfort (☀) and ECO mode (☾).
7. Use buttons - or + to move the marker (at the bottom of the display). When moving the marker from one interval to another save the selected mode to that interval.
8. Repeat steps 6 and 7 until the display shows **23:30**.
9. Press + to finalize programming the current day.  
The text **Copy Yes** appears (Yes is flashing).
10. Use buttons - or + to select **Yes** or **No** and press **OK** to confirm.  
Select **Yes** to copy the setting of the current day to the next. Repeat for every day that should be identical.  
Select **No** and press **OK** to create a new scheduling interval for the following day. Then repeat steps 6 through 10 until the whole week is programmed.
11. The display returns to the settings menu when the final day is done.

## 02 HEATING/COOLING CHANGEOVER

In this menu it is manually set whether the system is in heating, cooling or slave mode. In slave mode, an external signal decides when to switch to cooling.

To change this setting:

1. Press **OK** to enter parameter edit mode.
2. Use buttons - or + (T-169 = ▼ or ▲) to change the setting, see list below.

T-169	T-166/ T-168	Description
	H	Heating (heating demand icon flashes in T-166 and T-168)
	C	Cooling (cooling demand icon flashes in T-166 and T-168)

3. Press **OK** to confirm the change and return to the settings menu.

## 03 ECO MODE SETBACK TEMPERATURE

In this menu the setback temperature for whenever the channel is in ECO mode is set.

The setting adjusts the current setpoint with the set value. In heating mode the setpoint is reduced, and in cooling mode it is increased.

If the setback temperature is set to 0, the thermostat will remain unaffected if a program sets the system in ECO mode.

To change this setting:

1. Press **OK** to enter parameter edit mode.
2. Use buttons - or + (T-169 = ▼ or ▲) to change the parameter.

*Default: 4 °C*

*Setting range: 0 – 11 °C, 0.5 °C increments*

3. Press **OK** to confirm the change and to return to the settings menu.

## 04 CONTROL MODE





In this menu, control mode for the thermostat is set.

If an external sensor is connected to the thermostat, a control mode must be chosen to accommodate the extra functionality of the sensor.

Current control mode is displayed (**RT**, **RFT**, **RS** or **RO**).

To change this setting:

1. Press **OK** to enter parameter edit mode.
2. Use buttons - or + (T-169 = ▼ or ▲) to change control mode (see list below).

T-169	T-166/ T-168	Description
	RT	Room temperature
	RFT	Room temperature with external floor sensor (limitations does not affect the operation of the Move controller, when not integrated to a Wave controller)
	RS	Remote sensor
	RO	Room temperature with remote outdoor sensor

3. Press **OK** to confirm the change and return to the settings menu.

### 05 HIGH FLOOR TEMPERATURE LIMITATION

In this menu a limit on the maximum allowable floor temperature is set. Limitations does not affect the operation of the Move controller, when not integrated to a Wave controller.

*This menu is only visible if control mode RFT is activated in settings menu 04.*

To change this setting:

1. Press **OK** to enter parameter edit mode.
2. Use buttons - or + (T-169 = ▼ or ▲) to change the parameter.

*Default: 26 °C*

*Setting range: 20 – 35 °C, 0.5 °C increments*



#### NOTE!

This parameter cannot be set lower than the set value in settings menu **06 Low floor** temperature limitation.

3. Press **OK** to confirm the change and return to the settings menu.

### 06 LOW FLOOR TEMPERATURE LIMITATION

In this menu a limit on the minimum allowable floor temperature is set. Limitations does not affect the operation of the Move controller, when not integrated to a Wave controller.

*This menu is only visible if control mode RFT is activated in settings menu 04.*

To change this setting:

1. Press **OK** to enter parameter edit mode.
2. Use buttons - or + (T-169 = ▼ or ▲) to change the parameter.

*Default: 20 °C*

*Setting range: 10 – 30 °C, 0.5 °C increments*



#### NOTE!

If this parameter is set lower than 16 °C the cooling icon will start flashing, warning for risk of condensation in the system.



#### NOTE!

This parameter cannot be set higher than the set value in settings menu **05 High floor** temperature limitation.

3. Press **OK** to confirm the change and return to the settings menu.

### 07 COOLING ALLOWED

In this menu it is set whether cooling is allowed in the system or not.

To change this setting:

1. Press **OK** to enter parameter edit mode.
2. Use buttons - or + (T-169 = ▼ or ▲) to toggle between **Yes** and **No**.

T-169	T-166/ T-168	Description
	Yes	Shows the cooling demand icon
	No	Hides the cooling demand icon

3. Press **OK** to confirm the change and return to the settings menu.



## 08 DISPLAY UNIT

In this menu temperature display unit is set.

To change this setting:

1. Press **OK** to enter parameter edit mode.
2. Use buttons - or + (T-169 = ▼ or ▲) to toggle between Celsius and Fahrenheit.

T-169	T-166/ T-168	Description
°C	DEg °C	Degrees Celsius
°F	DEg °F	Degrees Fahrenheit

3. Press **OK** to confirm the change and return to the settings menu.

## 09 CLIMATIC CONTROLLER INTEGRATION

In this menu the thermostat is registered to the Move controller.

Default value: **no**

To change this setting:

1. Press **OK** to enter parameter edit mode.
2. Use buttons - or + (T-169 = ▼ or ▲) to toggle between **no**, **YEs** and **CnF**.

T-169	T-166/ T-168	Description
(ⓘ) ✕	no	Not integrated
(ⓘ) ✓	YEs	Integrated (requires to be registered with the Move controller first)
(ⓘ)	CnF	Register with the Move controller, confirm on the Move controller

3. Press **OK** to confirm the change and return to the settings menu.

## 10 TIME AND DATE (T-168 ONLY)

In this menu time and date is set. This setting is required to utilise scheduling programs for this thermostat.

Use buttons - or + to change the value. Press the **OK** button to set the value and move to the next editable value.

To change this setting:

1. Press **OK** to enter parameter edit mode.
2. Set hours.
3. Set minutes.
4. Set 12 h or 24 h display of time.
5. Set day of the week (1 = Monday, 7 = Sunday).
6. Set day of the month.
7. Set month.
8. Set year.
9. Press **OK** to confirm change and return to the settings menu.

## 11 ROOM TEMPERATURE CALIBRATION

In this menu the room temperature shown in the thermostat display can be calibrated.

To change this setting:

1. Press **OK** to enter parameter edit mode.
2. Use buttons - or + (T-169 = ▼ or ▲) to change the parameter.  
*Default: 0.0 °C*  
*Setting range: -6.0 – 6.0 °C, 0.1 °C increments*
3. Press **OK** to confirm the change and return to the settings menu.

## 12 INVERT SCREEN (T-169 ONLY)

In this menu the colour in the display can be inverted.

To change this setting:

1. Press **OK** to enter parameter edit mode.
2. Use buttons ▼ or ▲ to change the screen setting.
3. Press **OK** to confirm the change and return to the settings menu.

## 10.10 Replace batteries

### THERMOSTATS T-166 AND T-168

Replace the batteries of the thermostat when the low battery icon  is shown in the display.

The illustration below shows how to change batteries.

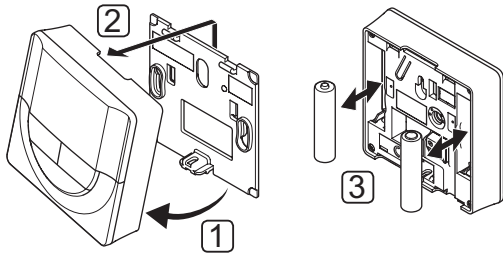

1. Angle the thermostat from the bracket.
2. Remove it from the wall.
3. Replace batteries.

### THERMOSTAT T-169

Replace the battery of the thermostat when the low battery icon  is shown in the display (alarm list).

The illustration below shows how to replace the battery.

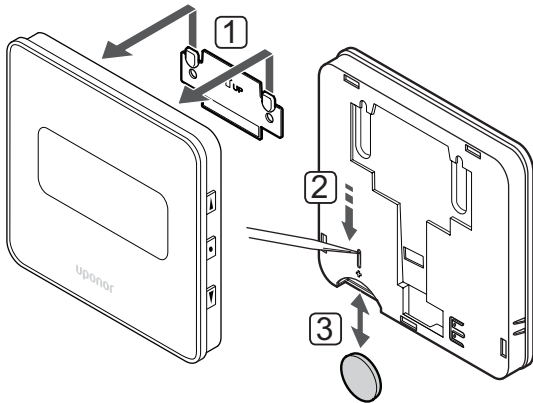

To replace the battery:

1. Remove the thermostat from the wall.
2. Use a pointed object to remove the battery.
3. Replace the battery.

## 10.11 Factory reset

Factory reset sets all parameter values to default settings.



### NOTE!

Do not factory reset the thermostat if not absolutely needed.



### NOTE!

A factory reset removes the registration data from the thermostat.

### THERMOSTATS T-166 AND T-168

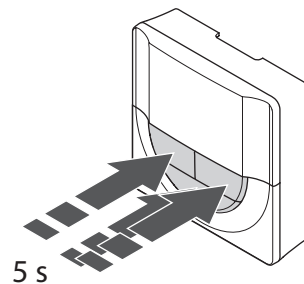

To factory reset the thermostat:

1. Press and hold the **-**, **+** and **OK** buttons for about 5 seconds until the screen goes blank.
2. The thermostat is now reset to factory default.

### THERMOSTAT T-169

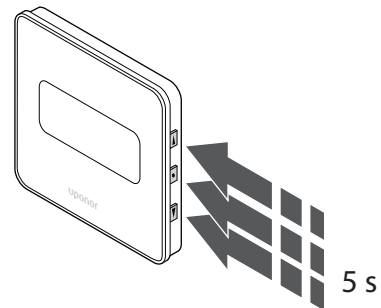

To factory reset the thermostat:

1. Press and hold the **▼**, **▲** and **OK** buttons for about 5 seconds until the screen goes blank.
2. The thermostat is now reset to factory default.

# 11 Maintenance

The maintenance of Uponor Smatrix Move includes the following:

- Manual preventive maintenance
- Automatic preventive maintenance
- Corrective maintenance

## 11.1 Manual preventive maintenance

Uponor Smatrix Move requires no preventive maintenance except cleaning:

1. Use a dry soft cloth to clean the components.



### **STOP!**

Do not use any detergents to clean the Uponor Smatrix Move components.

## 11.2 Automatic preventive maintenance

The controller is fitted with an automatic valve and pump exercise function. The function is designed to prevent the pump and actuators from seizing up due to inactivity. The valve and pump exercise function is enabled from the factory and can be disabled in the system parameters.

*See section 8 Operate the Uponor Smatrix Move controller for more information.*

The function is activated at noon (12:00) if the valve and pump has not been operated for a period of 24 hours.

**12:00** The pump is activated for 1 minute.

**12:01** The actuator opens, operation takes 2 minutes.

**12:03** The actuator closes, operation takes 2 minutes.

## 11.3 Corrective maintenance

### **FALLBACK MODE**

If a thermostat is malfunctioning or not detected, the controller executes a fallback mode in an attempt to maintain the temperature in the zone (heating or cooling) until the problem is resolved.

# 12 Troubleshooting

The table below shows problems and alarms that can occur with Uponor Smatrix Move and describes solutions. A common cause of a problem though may be due to wrongly installed loops or mixed up thermostats.

Alarms are indicated by a flashing display and error messages on the display.

Problem	Indication	Probable cause	Solutions
Fluctuating floor temperature	Floor temperature is changing abnormally between hot and cold in heating mode	Supply water temperature is too high	<ul style="list-style-type: none"> <li>Check heat curve and mode setting</li> <li>Check boiler or shunt</li> <li>Reduce the setting for maximum supply water temperature</li> <li>Lower the temperature compensation parameter (system parameter 10) in small increments until the system stops fluctuating. Wait 24 hours between each increment change</li> </ul>
	Indoor temperature in reference room does not match setpoint on thermostat	Heating fall back function is activated due to lost communication with thermostat	<ul style="list-style-type: none"> <li>Check heat curve and mode setting</li> <li>Check the connection of the room thermostat</li> <li>Check batteries in room thermostat</li> <li>Reconnect if the connection is lost</li> </ul>
	Indoor temperature does not match setpoint on thermostat	The thermostat is placed in direct sunlight or close to other heating sources	<ul style="list-style-type: none"> <li>Check placement of the thermostat according to installation instructions and change location if needed</li> </ul>
Indoor temperature too cold (or too warm in cooling mode)	Press – or + buttons to display the temperature setpoint on the thermostat	The thermostat setting is too low	<ul style="list-style-type: none"> <li>Change the temperature setpoint</li> <li>Use maximum and minimum settings to protect the system from consequences of unreasonable temperature settings</li> </ul>
	The temperature displayed on the thermostat drops after the thermostat is moved	The thermostat may be influenced by an external heat source	<ul style="list-style-type: none"> <li>Change location of the thermostat</li> </ul>
	Calculated setpoint displayed on controller same as set maximum or minimum limits	Incorrect minimum/maximum limitation	<ul style="list-style-type: none"> <li>Change the minimum/maximum limitation (system parameters 2 and 3)</li> </ul>
	The indoor temperature reaches the setpoint slowly	The supply temperature compensation parameter is set too low.	<ul style="list-style-type: none"> <li>Raise the temperature compensation parameter (system parameter 10) in small increments until the system is quick enough. Wait 24 hours between each increment change</li> </ul>
	ECO mode icon displayed in the controller display	ECO mode	<ul style="list-style-type: none"> <li>Change ECO profile or assign another profile</li> </ul>
	Holiday mode icon displayed in the controller display	Holiday mode	<ul style="list-style-type: none"> <li>Cancel holiday mode</li> </ul>
	Indoor temperature too warm (or too cold in cooling mode)	Corresponding loop is warm even after a long period without heat call	Actuator does not close
The indoor temperature reaches the setpoint slowly		The supply temperature compensation parameter is set too low.	<ul style="list-style-type: none"> <li>Raise the temperature compensation parameter (system parameter 10) in small increments until the system is quick enough. Wait 24 hours between each increment change</li> </ul>
Floor is cold	Room temperature OK but floor is cold	<ul style="list-style-type: none"> <li>No heat demand from underfloor heating system</li> <li>Room is heated by another heat source</li> </ul>	
Disturbing noise from pump at same time and day of week		Pump exercise function active	



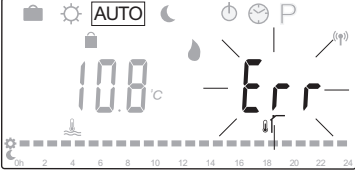



## 12.1 Troubleshooting after installation

Problem	Indication	Probable cause	Solutions
The system does not start	The display is not illuminated	There is no AC power to the controller	<ol style="list-style-type: none"> <li>1. Check that the controller is connected to AC power</li> <li>2. Check the wiring in the 230 V compartment</li> <li>3. Check that there is 230 V AC power in the wall socket</li> </ol>
	There is 230 V AC power in the wall socket	Faulty power cable	Replace the power cable and plug
Display shows error in run mode		Outdoor sensor not connected	<ol style="list-style-type: none"> <li>1. Check whether the connection of sensor cable is correct</li> <li>2. Check the sensor cable for damages</li> <li>3. Replace the sensor cable</li> <li>4. Replace the sensor, if necessary</li> <li>5. Check if the wireless thermostat (requires antenna A-155) is registered correctly</li> </ol>
Poor radio reception	Radio alarm. If no radio signal is received during more than 1 hour the display and the small RF antenna logo (📶) for wireless connection will appear flashing	<p>The antenna is installed inside a metal cabinet or too close to other shielding objects</p> <p>The building structure is unfavourable for radio transmission</p> <p>The thermostat batteries are discharged</p>	<p>Change the antenna location. If the problem persists, contact the installer</p> <p>Replace batteries</p>
Thermostats is not registering	<b>INI thrF</b> still appears on the display after setting the controller in <b>INI thrF</b> mode and the thermostat in <b>rF</b> init mode	The antenna is not installed or positioned correctly	Check the wiring and antenna connection









## 12.2 Digital thermostats T-166, T-168 and T-169, alarms/problems

An alarm is sent when more than 1 hour have elapsed since the controller received the last radio signal from the thermostat.

The table below shows problems that can occur in the digital thermostats T-166 and T-168.

Indication	Probable cause	Solutions
The battery icon  is displayed	The thermostat battery power is running low	Replace the batteries
The display is off	The batteries are discharged or wrong type of battery is used	Replace the batteries
	The batteries are installed upside down (reverse polarity)	Install the batteries correctly
The radio transmission icon is displayed but signals are received only when thermostat is close to the antenna	The transmitter is working with reduced signal intensity	Force thermostat to transmit by changing temperature setpoint Replace the thermostat
	New installations in the building are shielding radio signals (for example, a metal door safe)	Try to find new position for thermostat and/or antenna, or, if possible, shielding object
No radio transmission icon  is displayed on the thermostat screen when -/+ buttons are pressed	The transmitter in the thermostat is broken	Force the thermostat to transmit by changing temperature setpoint Replace the thermostat
The relative humidity icon  is displayed (T-168 only)	The relative humidity limit is reached	Lower the humidity level
The icon for floor temperature sensor  flashes	Faulty temperature sensor	Check the connection of the floor sensor Disconnect the floor temperature sensor and check it with an ohmmeter. The value must be around 10 kohms
The icon for outdoor temperature sensor  flashes	Faulty temperature sensor	Check the connection of the outdoor sensor Disconnect the outdoor sensor and check it with an ohmmeter. The value must be around 10 kohms
The icon for indoor temperature sensor  flashes	Faulty temperature sensor	Contact the installer or replace the thermostat Disconnect the remote temperature sensor (if connected) and check it with an ohmmeter. The value must be around 10 kohms

The table below shows problems that can occur in the digital thermostat T-169.

Indication	Probable cause	Solutions
Alarm icon  is displayed	An error has occurred	Go to the alarm list for more information
Battery icon  is displayed in the alarm list	Thermostat battery power is running low	Replace the battery
The display is off	The battery is discharged or wrong type of battery is used	Replace the battery
	The battery are installed incorrectly (reverse polarity)	Install the battery correctly
Radio transmission error icon  is displayed in the alarm list	Transmitter working with reduced signal intensity	Force the thermostat to transmit by changing the temperature setpoint Replace thermostat
	New installations in building shield radio signals (for example, metal door safe)	Try to find a new position for the thermostat and/or the antenna, or, if possible, move the shielding object
	The transmitter broken in the thermostat	Force the thermostat to transmit by changing the temperature setpoint Replace the thermostat
Relative humidity icon  is displayed in the alarm list	The relative humidity limit is reached	Lower the humidity level by increasing the ventilation or temperature setpoint
Floor temperature sensor icon  is displayed in the alarm list	Faulty temperature sensor	Check the connection of the floor sensor
		Disconnect the floor temperature sensor and check it with an ohmmeter. The value must be around 10 kohms
Outdoor temperature sensor icon  is displayed in the alarm list	Faulty temperature sensor	Check the connection of the outdoor sensor
		Disconnect the outdoor sensor and check it with an ohmmeter. The value must be around 10 kohms
Indoor temperature sensor icon  is displayed in the alarm list	Faulty temperature sensor	Contact the installer or replace the thermostat
Remote temperature sensor icon  is displayed in the alarm list	Faulty temperature sensor	Contact the installer or replace the remote sensor
		Disconnect the remote temperature sensor (if connected) and check it with an ohmmeter. The value must be around 10 kohms

### 12.3 Analogue thermostat T-163, alarms/problems

An alarm is sent when more than 1 hour have elapsed since the controller received the last radio signal from the thermostat.

The table below lists problems that can occur in the public thermostat T-163.

Indication	Probable cause	Solutions
The LED flashes twice	The thermostat battery power is running low	Replace the batteries

### 12.4 Controller, alarms/problems

An alarm is sent when more than 1 hour have elapsed since the controller received the last radio signal from the thermostat.

The table below lists problems that can occur in the controller.

Indication	Probable cause	Solutions
The radio icon  is not displayed in the controller display	The antenna is out of position or the wire is disconnected	Install the antenna in a correct position with the wire correctly connected

## 12.5 Contact installer

For installer contact information, see the installation report in the end of this document. Prepare the following information before contacting an installer:

- Installation report
- Drawings of the underfloor heating system (if available)
- List of all alarms, including time and date

## 12.6 Installer instructions

To determine if a problem is caused by the supply system or the control system, loosen the actuators from the manifold for the room concerned. Wait a few minutes and check if the flow pipe of the underfloor heating loop becomes warm.

If the pipe does not become warm, the problem is in the heating system. If the loop becomes warm, the cause could be the room control system.

A supply system defect can be indicated by no warm water in the manifold. Check the boiler and circulation pump.



# 13 Technical data

## 13.1 Technical data

<b>General</b>	
IP	IP30 (IP: degree of inaccessibility to active parts of the product and degree of water)
Max. ambient RH (relative humidity)	85% at 20 °C
<b>Thermostat (requires antenna A-155)</b>	
CE marking	
ERP	IV
Low voltage tests	EN 60730-1* and EN 60730-2-9***
EMC (electromagnetic compatibility requirements) tests	EN 60730-1 and EN 301-489-3
ERM (electromagnetic compatibility and radio spectrum matters) tests	EN 300 220-3
Power supply (T-163, T-166, and T-168)	Two 1.5 V AAA alkaline batteries
Power supply (T-169)	1 x CR2032 3V
Voltage (T-163, T-166, and T-168)	2.2 V to 3.6 V
Voltage (T-169)	2.4 V to 3.6 V
Operating temperature	0 °C to +45 °C
Storage temperature	-10 °C to +65 °C
Radio frequency	868.3 MHz
Transmitter duty cycle	<1%
Connection terminals (T-163, T-166, and T-168)	0.5 mm <sup>2</sup> to 2.5 mm <sup>2</sup>
Connection terminals (T-169)	0.25 mm <sup>2</sup> to 0.75 mm <sup>2</sup> solid, or 0.34 mm <sup>2</sup> to 0.5 mm <sup>2</sup> flexible with ferrules
<b>Antenna</b>	
Power supply	5 V DC ±10 % from controller
Maximum power consumption	1 W
Radio frequency	868.3 MHz
Transmitter duty cycle	1%
Receiver class	2

Controller	
CE marking	
ERP	VII (with thermostat) / III
Low voltage tests	EN 60730-1* and EN 60730-2-1**
EMC (electromagnetic compatibility requirements) tests	EN 60730-1 and EN 301-489-3*
ERM (electromagnetic compatibility and radio spectrum matters) tests	EN 300 220-3*
Power supply	230 V AC +10/-15%, 50 Hz
Operating temperature	0 °C to +50 °C
Storage temperature	-20 °C to +70 °C
Maximum consumption	75 W
Pump 1 output	230 V AC +10/-15%, 250 V AC 5 A maximum (L, N, PE)
Heating output	230 V AC +10/-15%, 250 V AC 5 A maximum (L, N, PE)
Cooling/Pump 2 output	230 V AC +10/-15%, 250 V AC 5 A maximum (L, N, PE)
3-point control	2 TRIACS => 75 W max
Valve output	230 V AC ±10%,
Connection terminals	Up to 4.0 mm <sup>2</sup> solid, or 2.5 mm <sup>2</sup> flexible with ferrules

\*) EN 60730-1 Automatic electrical controls for household and similar use  
-- Part 1: General requirements

\*\*) EN 60730-2-1 Automatic electrical controls for household and similar use  
-- Part 2-1: Particular requirements for electrical controls for electrical household appliances

\*\*\*) EN 60730-2-9 Automatic electrical controls for household and similar use  
-- Part 2-9: Particular requirements for temperature sensing controls

Usable in all Europe



Declaration of conformity:

We hereby declare under our own responsibility that products dealt with by these instructions satisfy all essential demands linked to the information stated in the Safety instruction booklet.



(Move without antenna A-155 only)

## 13.2 Technical specifications

Cables	Standard cable length	Maximum cable length	Wire gauge
Cable from controller to antenna	0.30 m	10 m	<b>Controller:</b> Plug connector <b>Antenna:</b> Plug connector
Cable from controller to actuator	0.75 m	20 m	<b>Controller:</b> 0.2 mm <sup>2</sup> to 1.5 mm <sup>2</sup>
External sensor cable to thermostat	5 m	5 m	0.6 mm <sup>2</sup>
Floor sensor cable to thermostat	4 m	4 m	0.75 mm <sup>2</sup>
Cable from relay switch to controller heating/cooling input	2 m	20 m	<b>Controller:</b> 0.2 mm <sup>2</sup> to 1.5 mm <sup>2</sup> <b>Relay:</b> 1.0 mm <sup>2</sup> to 4.0 mm <sup>2</sup>
Cable from external heating/cooling controller to relay coil	10 m	Can be extended up to 100 m, but must be checked by installer	<b>External heating/cooling controller:</b> manufacturer-specific <b>Relay:</b> 1.5 mm <sup>2</sup> to 4.0 mm <sup>2</sup>

### 13.3 Controller layout

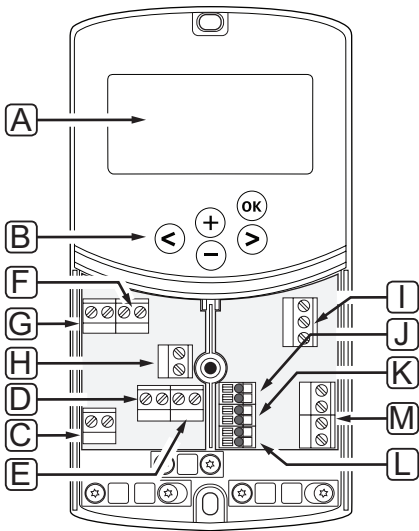

Item	Description
A	Display
B	Buttons
C	Terminal block, earth
D	Terminal block, circulation pump, mixing circuit 1
E	Terminal block, power supply
F	Terminal block, cooling output or various applications
G	Terminal block, heating output
H	Terminal block, optional temperature limiter Fitted from the factory with a cable bridge, which must be removed before connecting a temperature limiter
I	Terminal block, valve actuator
J	Terminal block, outdoor sensor
K	Terminal block, return temperature sensor
L	Terminal block, supply temperature sensor
M	Terminal block, wired inputs 1 and 2 Optional immersion thermostat or external heating/cooling signal

### 13.4 Controller wiring diagram

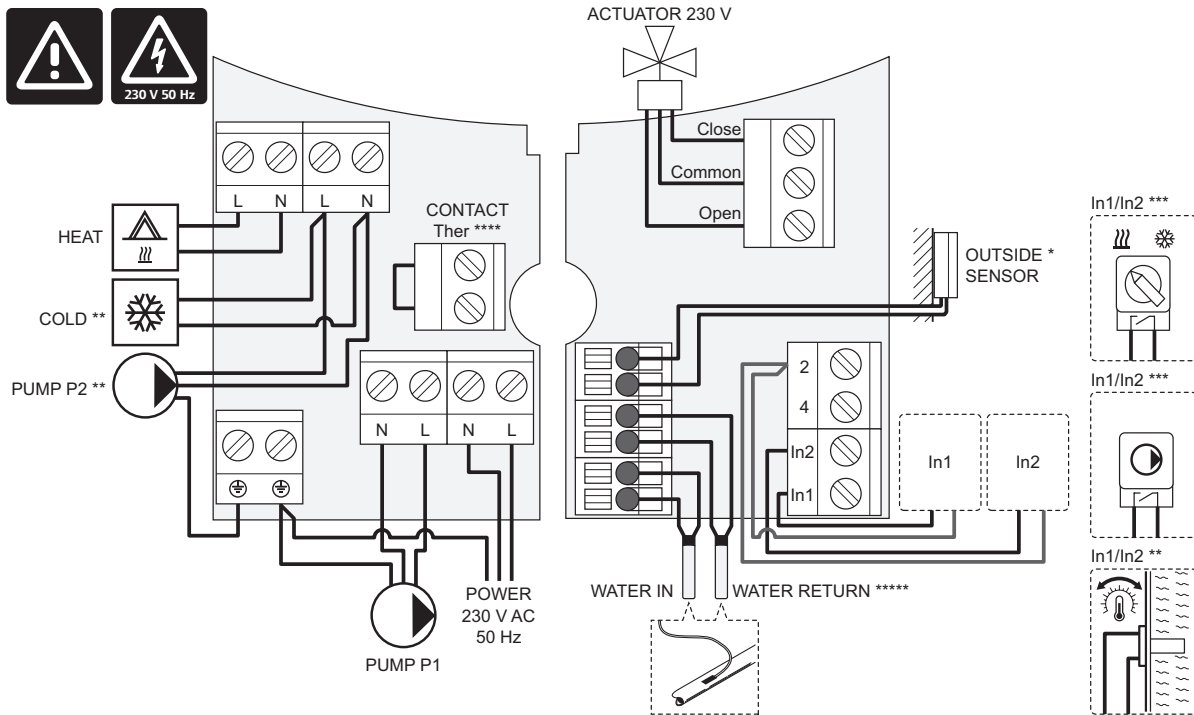

- \*) The outdoor temperature sensor can be connected to either the controller or to a thermostat.
- \*\*\*) Connect either COLD or PUMP P2 (secondary heating/cooling circuit) to the connection terminal.
- \*\*\*\*) Select one of the inputs (heating/cooling switch, pump control signal, or immersion thermostat) and set parameter 11 – Wired Input 1 selection, or parameter 12 – Wired Input 2 Selection, accordingly. The heating/cooling option can only be used in systems without a registered wireless thermostat.
- \*\*\*\*\*) Optional temperature limiter connection, fitted with a cable bridge from the factory. Remove the bridge if a temperature limiter is to be used together with PUMP P1.
- \*\*\*\*\*) Optional return sensor. Can only be used in systems without a registered wireless thermostat.

### 13.5 Reference data for sensors

#### REFERENCE VALUE FOR SENSORS

Check with an ohmmeter. The sensor must be unplugged

Temperature (°C)	Resistance (Ohm)	Temperature (°C)	Resistance (Ohm)
-20	~ 94 kΩ	40	~ 5.3 kΩ
-10	~ 54 kΩ	50	~ 3.6 kΩ
0	~ 32 kΩ	60	~ 2.5 kΩ
10	~ 20 kΩ	70	~ 1.8 kΩ
20	~ 12.5 kΩ	80	~ 1.3 kΩ
30	~ 8 kΩ		

#### SENSOR DATA

Sensor	
Outdoor temperature	CTN 10 kΩ at 25 °C (class II, IP55)
Supply water temperature	CTN 10 kΩ at 25 °C (class I, IP68, no coupling)
Return water temperature	CTN 10 kΩ at 25 °C (class I, IP68, no supply)

### 13.6 Dimensions

#### CONTROLLER

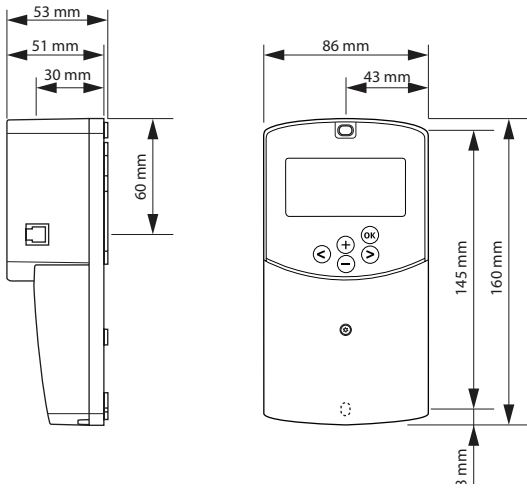

#### CONTROLLER ANTENNA A-155

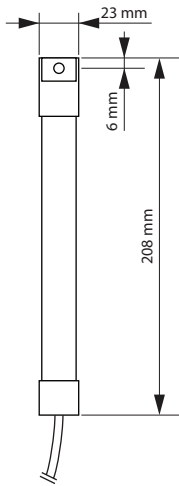

#### THERMOSTATS

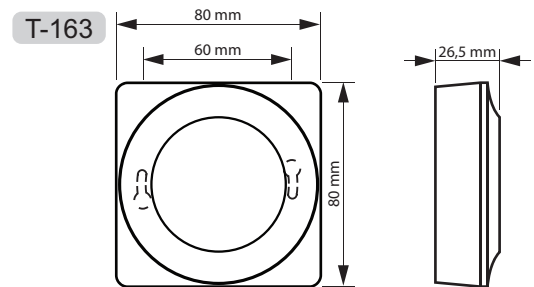
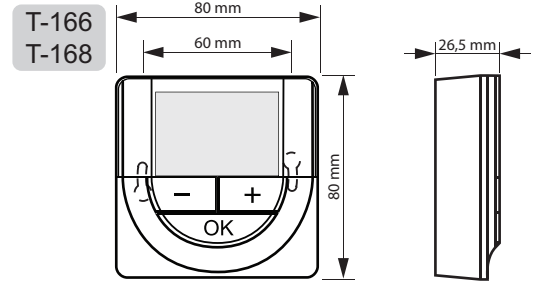
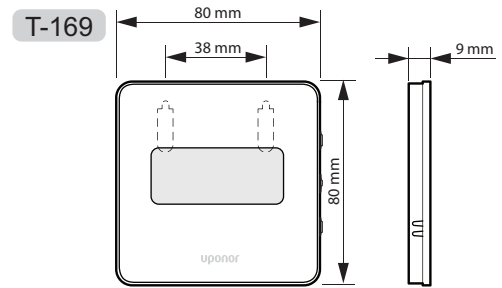

# 14 Installation report

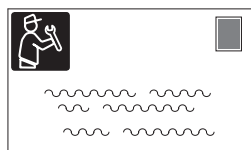
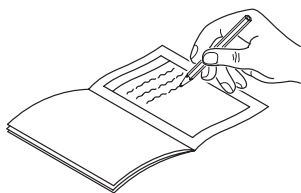

---



---



---



---

Thermostat	Controller channel	
 T-169		
 T-168		
 T-166		
 T-165		
 T-163		
<b>Connected external sensor</b>		
Outdoor sensor		
Floor sensor		
Remote sensor		
<b>Actuator</b>		
 Actuator	Yes <input type="checkbox"/>	No <input type="checkbox"/>
<b>Room name</b>		

Other connections		
Antenna	Yes <input type="checkbox"/>	No <input type="checkbox"/>
Outdoor sensor wired to controller	Yes <input type="checkbox"/>	No <input type="checkbox"/>
Outdoor sensor wired to thermostat*	Yes <input type="checkbox"/>	No <input type="checkbox"/>
Heating/cooling	Yes <input type="checkbox"/>	No <input type="checkbox"/>
Heating system or boiler	Yes <input type="checkbox"/>	No <input type="checkbox"/>
Chiller	Yes <input type="checkbox"/>	No <input type="checkbox"/>
Supply sensor	Yes <input type="checkbox"/>	No <input type="checkbox"/>
Return sensor (optional)	Yes <input type="checkbox"/>	No <input type="checkbox"/>
Circulation pump 1	Yes <input type="checkbox"/>	No <input type="checkbox"/>
Circulation pump 2 (optional)	Yes <input type="checkbox"/>	No <input type="checkbox"/>
Integration** with Uponor Smatrix Wave system	Yes <input type="checkbox"/>	No <input type="checkbox"/>
Wired Input 1	Yes <input type="checkbox"/>	Aqu <input type="checkbox"/>
	No <input type="checkbox"/>	HC <input type="checkbox"/>
Wired Input 2	Yes <input type="checkbox"/>	Aqu <input type="checkbox"/>
	No <input type="checkbox"/>	HC <input type="checkbox"/>

\*) Requires antenna A-155

\*\*) Requires antenna A-155 and a wireless thermostat



A series of horizontal dotted lines spanning the width of the page, providing a template for handwritten notes or instructions.



**Uponor Ltd**  
[www.uponor.co.uk](http://www.uponor.co.uk)

Uponor reserves the right to make changes, without prior notification, to the specification of incorporated components in line with its policy of continuous improvement and development.

**Uponor**