

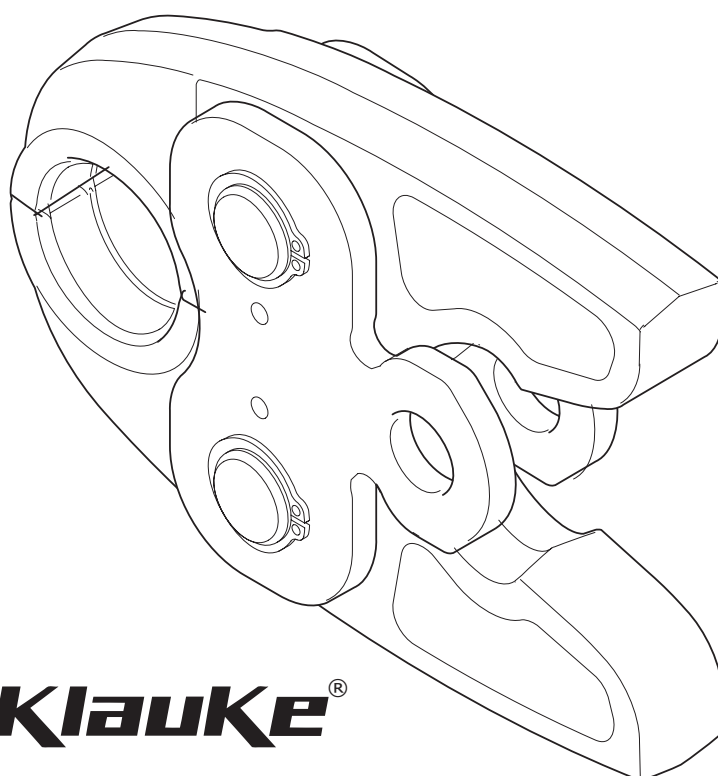

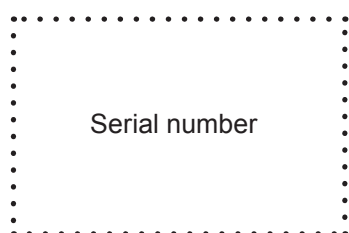

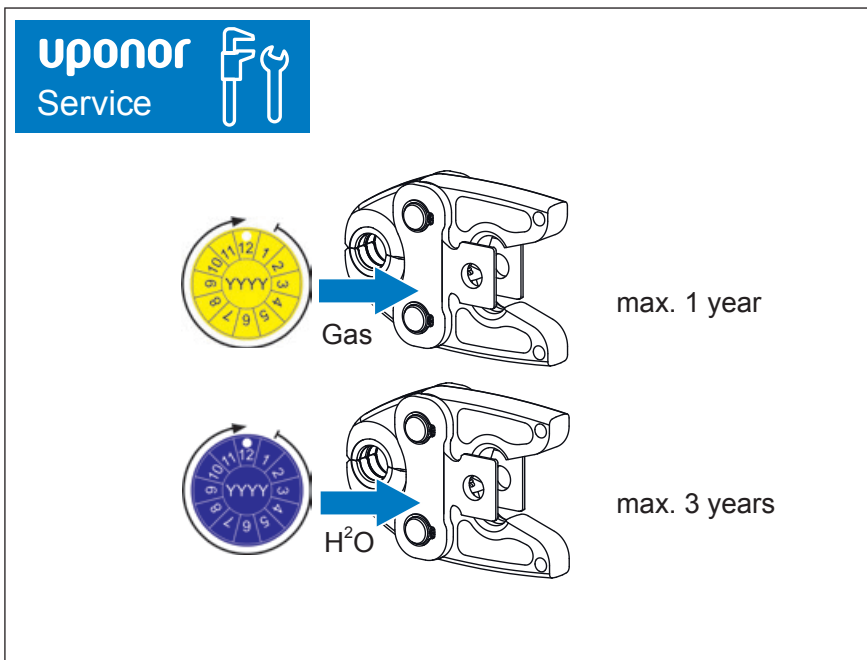

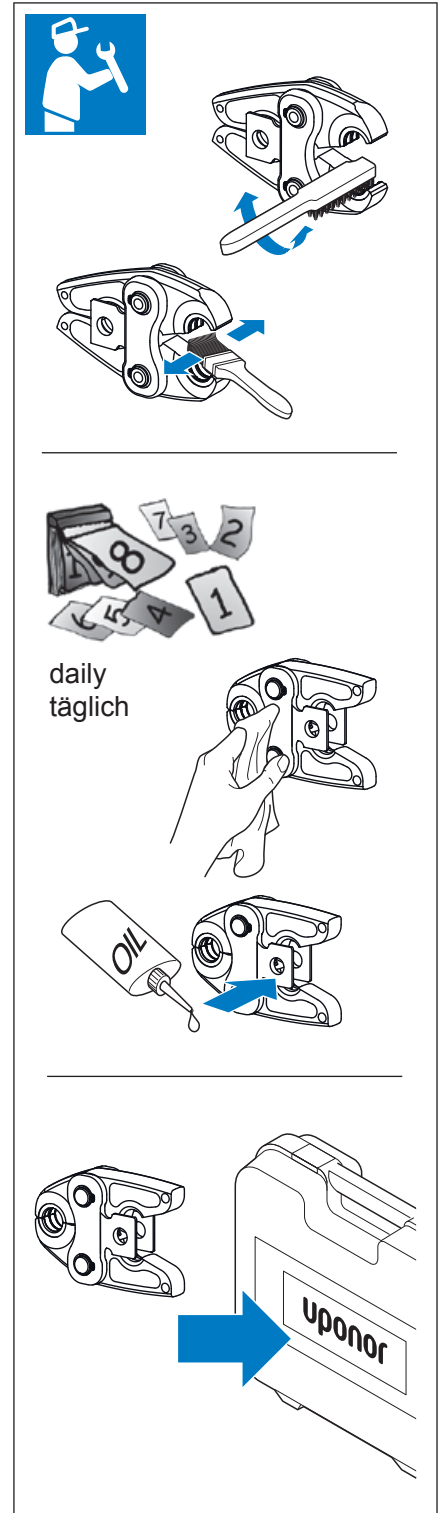

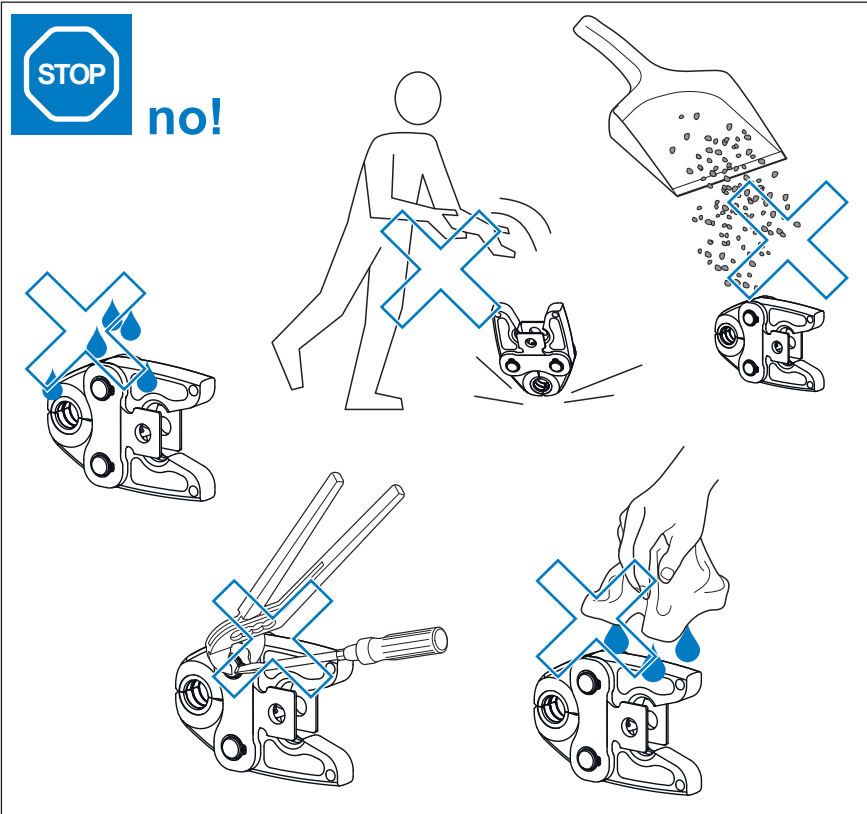
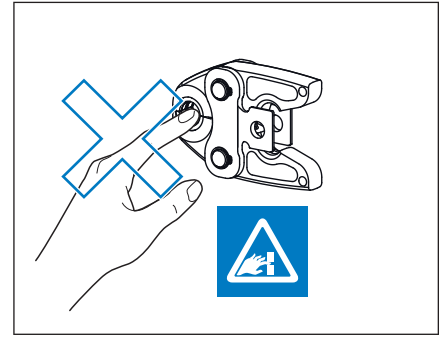
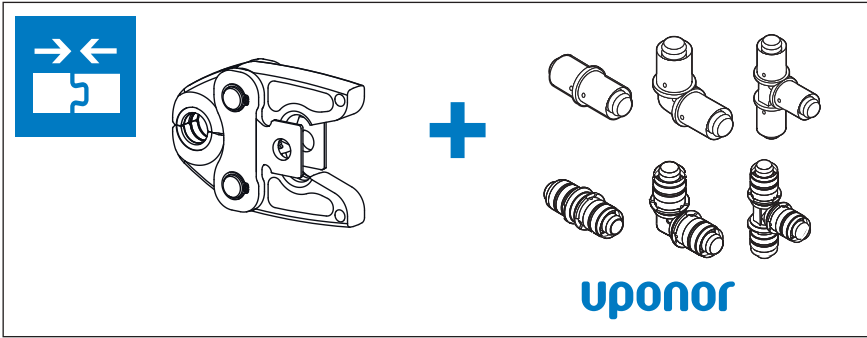

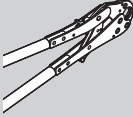
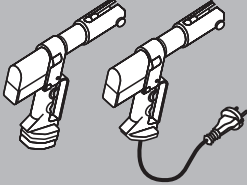

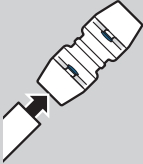
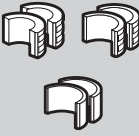
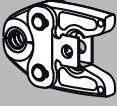
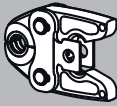
Uponor UPP1 S-Press jaw 14–50

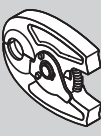
Serial number

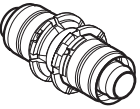
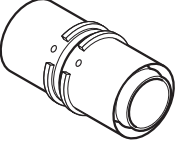

Klauke[®]

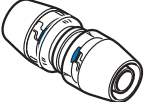

		UP110 UP75 UP75 EL 			Mini 2 Mini 		
		UPP1 	UPP1 				
 PPSU	14 – 20	16 – 32	40 – 50	63 – 75	16 – 32	–	–
	14 – 20	14 – 32	–	–	14 – 32	–	–
	–	–	40 – 50	–	–	–	–
	–	 25 – 32	 40 – 50	 63 – 110	 25 – 32	–	–
	–	–	–	–	–	14 – 25	–
	–	–	–	–	–	–	16 – 32

Uponor

Uponor

Uponor GmbH
Industriestraße 56
97437 Haßfurt
Germany
E info.de@uponor.com

Klauke[®]

Gustav Klauke GmbH
Auf dem Knapp 46
D-42855 Remscheid
Phone +49 (0)2191 907-2321
Fax +49 (0)2191 907-251
www.klauke.com

