

Uponor Smatrix Base/Base PRO

SI Poročilo o vgradnji/montaži

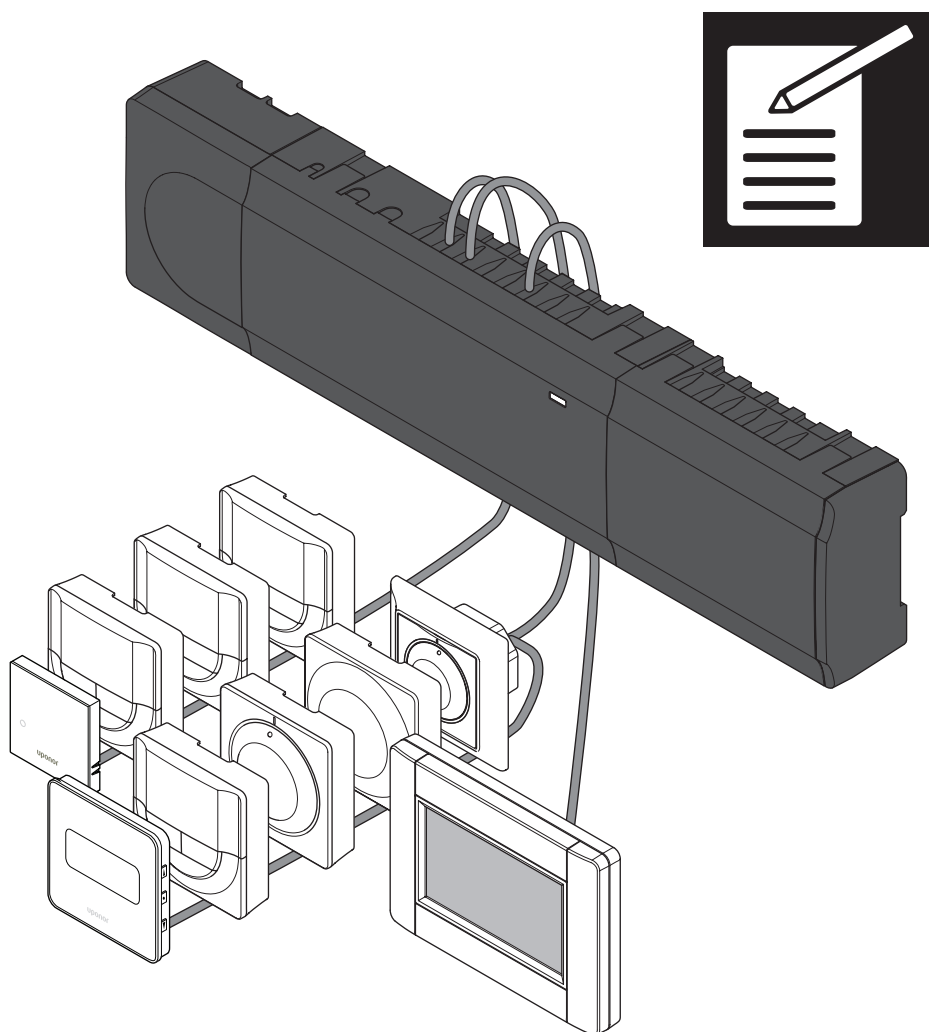

Poročilo o vgradnji/montaži

SI

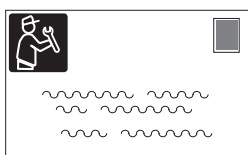
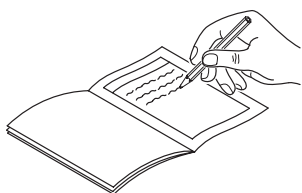

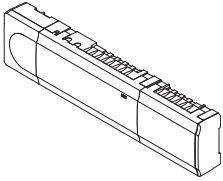
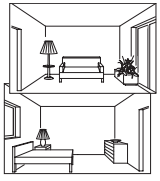

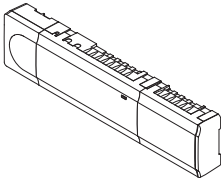
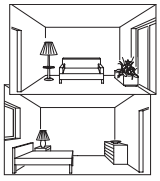





	Priključni modul								
	št. 1	št. 2	št. 3	št. 4	št. 5	št. 6	št. 7	št. 8	
Registrirana sistemska naprava									Ime prostora
Vmesnik									
Timer									
Zunanje tipalo									
Tipalo preklopa ogrevanje/hlajenje									
Preklopno stikalo ekonomični/komfortni način obratovanja									
Obtočna črpalka	Da <input type="checkbox"/>	Da <input type="checkbox"/>	Da <input type="checkbox"/>	Da <input type="checkbox"/>	Da <input type="checkbox"/>	Da <input type="checkbox"/>	Da <input type="checkbox"/>	Da <input type="checkbox"/>	
	Št. <input type="checkbox"/>	Št. <input type="checkbox"/>	Št. <input type="checkbox"/>	Št. <input type="checkbox"/>	Št. <input type="checkbox"/>	Št. <input type="checkbox"/>	Št. <input type="checkbox"/>	Št. <input type="checkbox"/>	
Zvezdasti modul	Da <input type="checkbox"/>	Da <input type="checkbox"/>	Da <input type="checkbox"/>	Da <input type="checkbox"/>	Da <input type="checkbox"/>	Da <input type="checkbox"/>	Da <input type="checkbox"/>	Da <input type="checkbox"/>	
	Št. <input type="checkbox"/>	Št. <input type="checkbox"/>	Št. <input type="checkbox"/>	Št. <input type="checkbox"/>	Št. <input type="checkbox"/>	Št. <input type="checkbox"/>	Št. <input type="checkbox"/>	Št. <input type="checkbox"/>	

	Priključni modul								
	št. 9	št. 10	št. 11	št. 12	št. 13	št. 14	št. 15	št. 16	
Registrirana sistemska naprava									Ime prostora
Vmesnik									
Obtočna črpalka	Da <input type="checkbox"/>	Da <input type="checkbox"/>	Da <input type="checkbox"/>	Da <input type="checkbox"/>	Da <input type="checkbox"/>	Da <input type="checkbox"/>	Da <input type="checkbox"/>	Da <input type="checkbox"/>	
	Št. <input type="checkbox"/>	Št. <input type="checkbox"/>	Št. <input type="checkbox"/>	Št. <input type="checkbox"/>	Št. <input type="checkbox"/>	Št. <input type="checkbox"/>	Št. <input type="checkbox"/>	Št. <input type="checkbox"/>	
Zvezdasti modul	Da <input type="checkbox"/>	Da <input type="checkbox"/>	Da <input type="checkbox"/>	Da <input type="checkbox"/>	Da <input type="checkbox"/>	Da <input type="checkbox"/>	Da <input type="checkbox"/>	Da <input type="checkbox"/>	
	Št. <input type="checkbox"/>	Št. <input type="checkbox"/>	Št. <input type="checkbox"/>	Št. <input type="checkbox"/>	Št. <input type="checkbox"/>	Št. <input type="checkbox"/>	Št. <input type="checkbox"/>	Št. <input type="checkbox"/>	

Priključni modul 1

SI

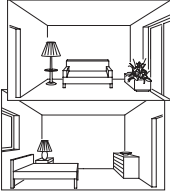
Termostat	Kanal regulatorja						Kanal pomožnega modula					
	1	2	3	4	5	6	7	8	9	10	11	12
 T-149												
 T-148												
 T-146												
 T-145												
 T-144												
 T-143												
 T-141												
Priključeno zunanje tipalo												
Talno tipalo												
Zunanje tipalo												
Daljinsko tipalo												
Priključen termopogon												
												
Ime prostora												
												



.....

.....

.....

.....









.....

.....

.....

Priključni modul 2

SI

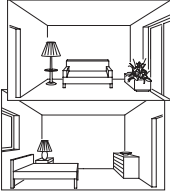
Termostat	Kanal regulatorja						Kanal pomožnega modula					
	1	2	3	4	5	6	7	8	9	10	11	12
 T-149												
 T-148												
 T-146												
 T-145												
 T-144												
 T-143												
 T-141												
Priključeno zunanje tipalo												
Talno tipalo												
Zunanje tipalo												
Daljinsko tipalo												
Priključen termopogon												
 24 V												
Ime prostora												
												



.....

.....

.....

.....









.....

.....

.....

Priključni modul 3

SI

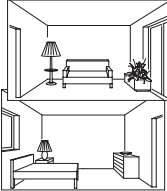
Termostat	Kanal regulatorja						Kanal pomožnega modula					
	1	2	3	4	5	6	7	8	9	10	11	12
 T-149												
 T-148												
 T-146												
 T-145												
 T-144												
 T-143												
 T-141												
Priključeno zunanje tipalo												
Talno tipalo												
Zunanje tipalo												
Daljinsko tipalo												
Priključen termopogon												
												
Ime prostora												
												



.....

.....

.....









.....

.....

.....

Priključni modul 4

SI

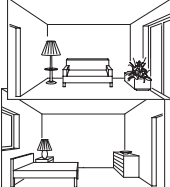
Termostat	Kanal regulatorja						Kanal pomožnega modula					
	1	2	3	4	5	6	7	8	9	10	11	12
 T-149												
 T-148												
 T-146												
 T-145												
 T-144												
 T-143												
 T-141												
Priključeno zunanje tipalo												
Talno tipalo												
Zunanje tipalo												
Daljinsko tipalo												
Priključen termopogon												
 24 V												
Ime prostora												
												



.....

.....

.....

.....









.....

.....

Priključni modul 5 – 16

To stran uporabljajte kot predlogo za priključne module Smatrix Base PRO od št. 5 – 16

SI

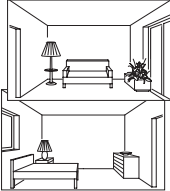
Termostat	Kanal regulatorja						Kanal pomožnega modula					
	1	2	3	4	5	6	7	8	9	10	11	12
 T-149												
 T-148												
 T-146												
 T-145												
 T-144												
 T-143												
 T-141												
Priključeno zunanje tipalo												
Talno tipalo												
Zunanje tipalo												
Daljinsko tipalo												
Priključen termopogon												
 24 V												
Ime prostora												
												



.....

.....

.....

.....

.....

.....



**Generalni zastopnik družbe Uponor
v Sloveniji, DOM-TITAN d.d.**

Kovinarska cesta 28
1241 Kamnik, Slovenija

1143290 v1_11_2023_SI
Production: Uponor / ELO

Uponor si za namene stalnih izboljšav in razvoja pridržuje pravico do sprememb ponudbe izdelkov in povezane dokumentacije brez predhodnega obvestila.



www.uponor.com/sl-si