

## Uponor Smatrix Wave Pulse

### Quick guide

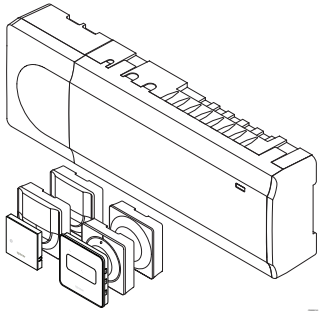

**1**

**2**

**3**

**4**

**5**

GPI

RELAY 1 (PUMP)

RELAY 2 (BOILER)

**6**

**6.1**

**6.2**

**6.3**

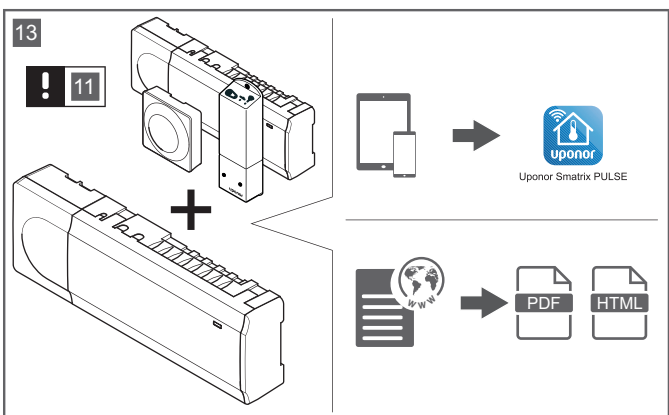
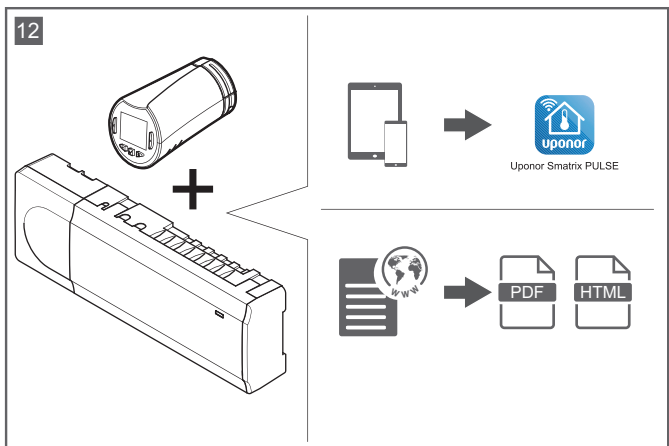
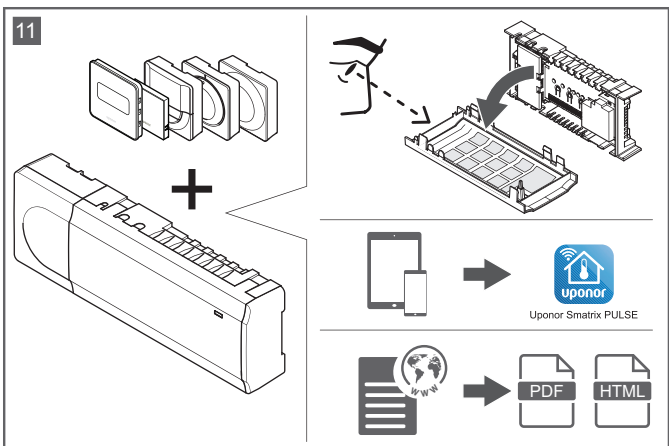
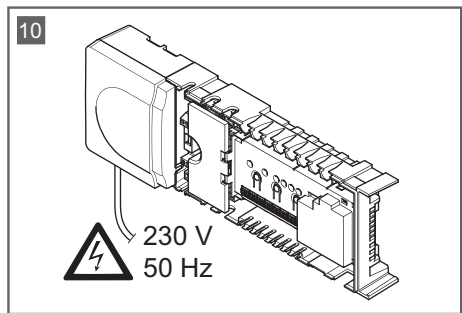
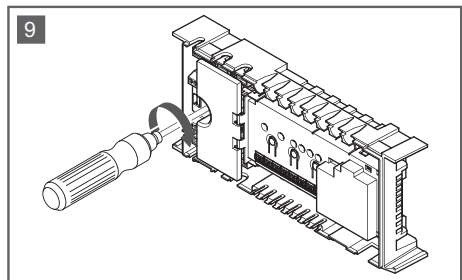
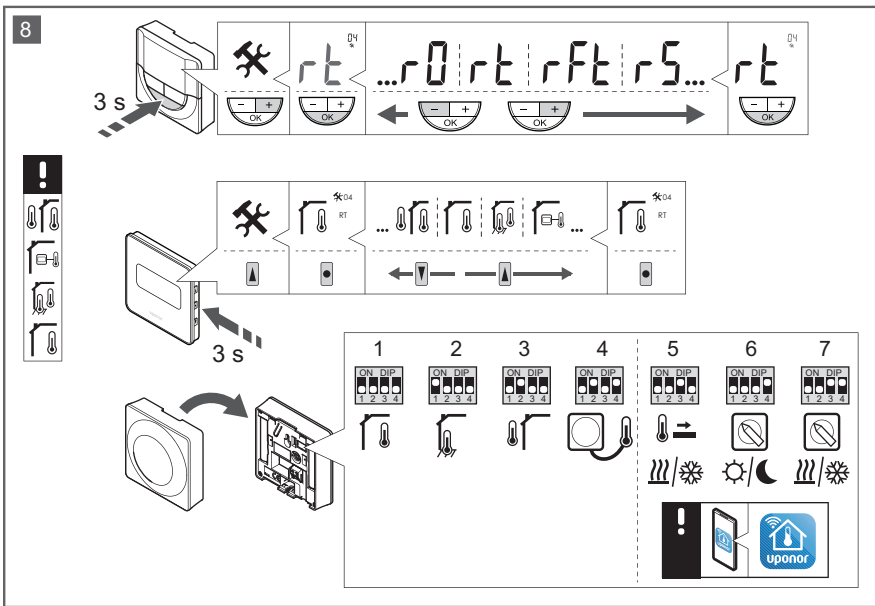
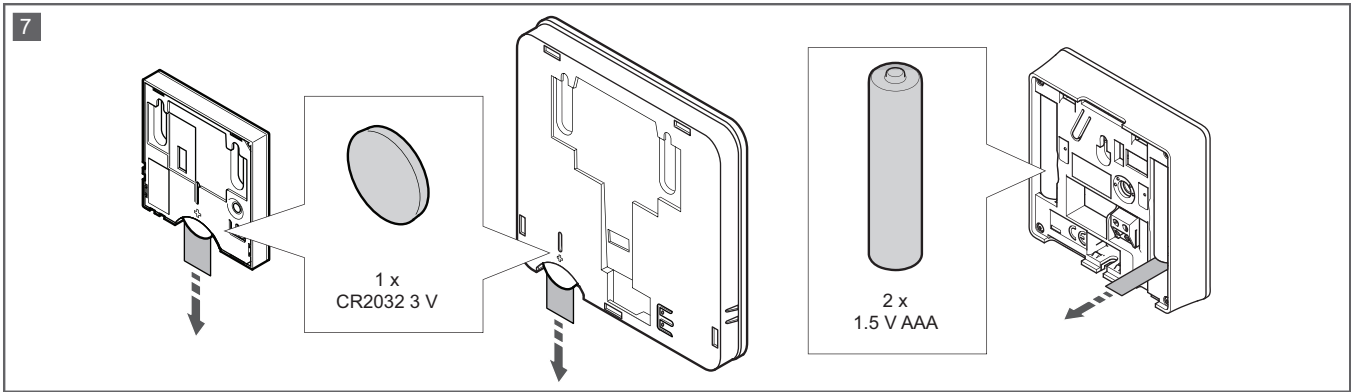

## Technical data



(869 MHz)

	IP20		T45		+70 °C ... -20 °C		ERP VIII
	IP20		T45		+65 °C ... -10 °C		ERP IV
	IP20		T40		+50 °C ... -10 °C		ERP IV
	IP20		T50		+70 °C ... -20 °C		ERP IV
	IP20		T45		+70 °C ... -20 °C		ERP IV
802.11 b/g/n @ 2.4Ghz, WPA & WPA2							
	IP20		T45		+70 °C ... -20 °C		ERP IV

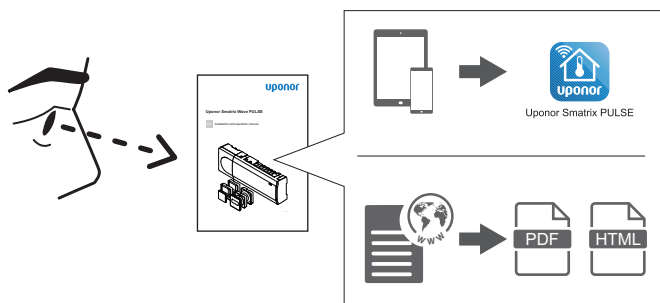

## EN Safety instructions

This quick guide serves as a reminder for experienced installers. We strongly recommend reading the full manual before installing the control system.

**Warning!**  
The Uponor system uses 50 Hz, 230 V AC power. In case of emergency, immediately disconnect the power.

**Warning!**  
Electrical installation and service behind secured 230 V AC covers must be carried out under the supervision of a qualified electrician.

**Warning!**  
The transformer module is heavy and might detach if the controller is held upside down without the cover on.

**Caution!**  
To avoid interference, keep installation/data cables away from power cables of more than 50 V.

**Caution!**  
If communication difficulties exist, Uponor recommends relocating the antenna to a more optimal position, and not installing Uponor radio sources too close to each other (**at least 40 cm apart**), for solving exceptional problems.

**Caution!**  
Ensure that each actuator is connected to the correct channel so that the thermostats are controlling the correct loops.  
Connect only one actuator for each channel. Channels 01 and 02 have double outputs (a and b) for two actuators.

**Caution!**  
If more than one controller is available in the system, register the thermostat as a system device to the master controller.

**Caution!**  
The switches in public the thermostat must be set before the thermostat is registered.

**Caution!**  
The switches, in the public thermostat, must be set to one of the available functions, otherwise it cannot be registered.









**Note**  
Registration of at least one thermostat must be done before registering a system device.

## CZ Bezpečnostní pokyny

Tento stručný průvodce slouží jako referenční příručka zkušeným instalačním technikům. Důrazně doporučujeme prostudovat si před instalací systému regulace celou příručku.





**Výstraha!**  
Systém Uponor využívá napájení 230 V~, 50 Hz. V nouzových případech napájení neprodleně odpojte.







**Výstraha!**  
Elektrická instalace a zásahy za zabezpečenými kryty 230 V~ musí probíhat pod dohledem kvalifikovaného elektrotechnika.

	<b>Výstraha!</b> Modul transformátoru je těžký a může se odpojit, pokud by řídicí jednotka byla držena v obrácené poloze bez nasazeného krytu.
	<b>Upozornění!</b> Abyste se vyvarovali rušení, udržujte instalační/datové kabely mimo napájecí kabely s více než 50 V.
	<b>Upozornění!</b> Pokud se vyskytnou potíže s komunikací, společnost Uponor doporučuje přemístit anténu na lepší místo a neinstalovat vysílače Uponor příliš blízko k sobě ( <b>minimální vzdálenost 40 cm</b> ); tím lze neobvyklé potíže zpravidla vyřešit.
	<b>Upozornění!</b> Každý servopohon se musí připojit ke správnému kanálu tak, aby každý termostat ovládal správné okruhy.  K jednomu kanálu připojujte pouze jeden servopohon. Kanály 01 a 02 mají dvojitě výstupy (a a b) pro dva servopohony.
	<b>Upozornění!</b> Pokud je v systému k dispozici více než jedna řídicí jednotka, zaregistrujte termostat jako systémové zařízení v hlavní řídicí jednotce.
	<b>Upozornění!</b> Spínače ve veřejném termostatu musí být nastaveny před registrací termostatu.
	<b>Upozornění!</b> Spínače ve veřejném termostatu musí být nastaveny na jednu z dostupných funkcí, jinak je nelze zaregistrovat.
	<b>POZNÁMKA!</b> K rozhraní mohou být zaregistrovány až čtyři řídicí jednotky.

## DE Sicherheitsvorschriften







Diese Kurzanleitung ist als Referenz für erfahrene Installateure gedacht. Vor Montage der Uponor Regelsystem empfehlen wir, unbedingt die vollständige Bedienungsanleitung durchzulesen.

	<b>Warnung!</b> Das Uponor System wird mit 230 V AC 50 Hz gespeist. Unterbrechen Sie in einem Notfall sofort die Stromversorgung.
	<b>Warnung!</b> Elektroinstallationen und -wartungsarbeiten hinter gesicherten 230-V-AC-Abdeckungen dürfen nur unter Aufsicht von qualifiziertem Fachpersonal durchgeführt werden.
	<b>Warnung!</b> Der Transformator ist schwer und kann herunterfallen, wenn das Regelmodul ohne Abdeckung kopfüber gehalten wird.
	<b>Achtung!</b> Um Störungen zu vermeiden, dürfen die Installations-/Datenkabel nicht in der Nähe von spannungsführenden Kabeln > 50 V verlegt werden.





	<b>Achtung!</b> Im Falle von Verbindungsstörungen empfiehlt Uponor, die Antenne in eine bessere Position zu bringen und Uponor Funkquellen nicht zu nahe bei einander zu platzieren ( <b>Mindestabstand 40 cm</b> ).
	<b>Achtung!</b> Stellen Sie sicher, dass jeder Stellantrieb an den richtigen Kanal angeschlossen ist, so dass die Raumfühler die richtigen Heizkreise regeln.  Schließen Sie nur einen Stellantrieb pro Ausgang an. Die Kanäle 01 und 02 haben doppelte Ausgänge (a und b) für zwei Stellantriebe.
	<b>Achtung!</b> Wenn mehr als ein Regelmodul im System verfügbar ist, müssen Systemgeräte dem Master-Regelmodul zugeordnet werden.
	<b>Achtung!</b> Die DIP-Schalter des Raumfühlers BM T-163 müssen eingestellt werden, bevor der Raumfühler zugeordnet wird.
	<b>Achtung!</b> Die DIP-Schalter des Raumfühlers T-163 müssen auf eine der verfügbaren Funktionen eingestellt werden, sonst kann der Raumfühler nicht zugeordnet werden.
	<b>HINWEIS!</b> Vor der Zuordnung eines Stellantriebs muss mindestens ein Raumfühler zugeordnet werden.

## DK Sikkerhedsforskrifter

Denne quick guide skal bruges som påmindelse for erfarne installatører. Vi anbefaler, at hele vejledningen læses, før kontrolsystemet installeres.











	<b>Advarsel!</b> Uponor-systemet bruger 50 Hz, 230 V vekselspænding. Afbryd omgående strømmen i nødstilfælde.
	<b>Advarsel!</b> Elektrisk installation og service bag sikrede 230 V vekselstrømsafskærmninger skal udføres af en autoriseret elektriker.
	<b>Advarsel!</b> Transformermodul er tungt og kan gå løs, hvis kontrolenheden holdes omvendt, uden at afskærmningen er på.
	<b>Forsigtig!</b> Undgå interferens ved at holde installations-/datakabler på afstand af kabler med mere end 50 V.
	<b>Forsigtig!</b> Hvis der er kommunikationsproblemer, anbefaler Uponor at flytte antennen til en mere optimal position og ikke installere Uponor-radiokilder for tæt på hinanden ( <b>minimum 40 cm afstand</b> ), hvilket kan løse særlige problemer.
	<b>Forsigtig!</b> Sørg for, at hver telestat er sluttet til den korrekte kanal, så termostaterne styrer de korrekte kredse.  Tilslut kun én telestat for hver kanal. Kanalerne 01 og 02 har dobbelt udgang (a og b) for to telestater.



	<b>Forsigtig!</b> Hvis mere end én kontrolenhed er tilgængelig i systemet, skal termostaten registreres som en systemenhed til masterkontrolenheden.
	<b>Forsigtig!</b> Kontakterne i institutionstermostaten skal indstilles, før termostaten registreres.
	<b>Forsigtig!</b> Kontakterne i institutionstermostaten skal indstilles til én af de tilgængelige funktioner, da den ellers ikke kan registreres.
	<b>BEMÆRK!</b> Mindst én termostat skal registreres, før en systemenhed registreres.











## EE Ohutusjuhised

Kiirjuhend on ette nähtud kasutamiseks kogenud paigaldajatele mälu värskendava abimaterjalina. Soovitame enne juhtsüsteemi paigaldamist kindlasti tutvuda põhijuhendiga.

	<b>Hoiatus!</b> Uponori süsteem kasutab 230 V vahelduvvoolu sagedusel 50 Hz. Hädaolukorras katkestage viivitamatult elektritoiteühendus.
	<b>Hoiatus!</b> Elektriseadmete paigaldamine ja 230 V AC kaitseluugi taga tehtavad hooldustööd tuleb teostada väljaõppinud elektrikuri järelevalve all.
	<b>Hoiatus!</b> Trafomoodul on raske ja võib ilma kaaneta kontrolleri tagurpidi hoidmise korral lahti tulla.
	<b>Ettevaatust!</b> Häirete vältimiseks hoidke paigaldus-/andmekaablid üle 50 V pingega elektri kaablitest eemal.
	<b>Ettevaatust!</b> Sidehäirete korral soovib Uponor paigutada antenni parema leviga kohta ning mitte paigaldada Uponori raadiosaatjaid üksteisele liiga lähedale ( <b>vähemalt 40 cm</b> ), et vältida tavatute häirete tekkimist.
	<b>Ettevaatust!</b> Veenduge, et iga ajam on ühendatud õige kanaliga nii, et termostaadid reguleerivad õigeid kütteringe.  Ühendage iga kanali kohta ainult üks ajam. Kanalitel 01 ja 02 on kaks väljundit (a ja b) kahe ajami ühendamiseks.
	<b>Ettevaatust!</b> Kui süsteemis on rohkem kui üks kontrolleri, registreerige termostaat süsteemiseadmena peakontrollerile.
	<b>Ettevaatust!</b> Üldkasutatava termostaadi lülitid tuleb seadistada enne termostaadi registreerimist.
	<b>Ettevaatust!</b> Üldkasutatava termostaadi lülitid tuleb seadistada lülitama mõnda kasutatavat funktsiooni, vastasel korral ei saa termostaati registreerida.
	<b>MÄRKUS!</b> Enne süsteemiseadme registreerimist tuleb registreerida vähemalt üks termostaat.











## ES Instrucciones sobre seguridad

Esta guía rápida sirve de recordatorio a los instaladores experimentados. Se recomienda leer íntegramente el manual antes de instalar el sistema de control.

	<b>Advertencia:</b> El sistema de Uponor utiliza alimentación 50 Hz, 230 V CA. En caso de emergencia, desconecte inmediatamente la alimentación.
	<b>Advertencia:</b> La instalación y el mantenimiento eléctricos de elementos protegidos con tapas y que funcionen a 230 V CA se debe llevar a cabo bajo la supervisión de un electricista cualificado.
	<b>Advertencia:</b> El módulo del transformador es pesado y se podría soltar en caso de colocar la unidad base boca abajo sin la correspondiente tapa.
	<b>Precaución:</b> Para evitar interferencias, mantenga los cables de instalación/datos alejados de los cables de alimentación de más de 50 V.
	<b>Precaución:</b> Si existe algún problema de comunicación, Uponor recomienda reubicar la antena en una posición más óptima, y no instalar fuentes de ondas de radio Uponor demasiado cerca entre sí para evitar posibles problemas ( <b>la separación mínima debe ser de 40 cm</b> ).
	<b>Precaución:</b> Compruebe que cada actuador está conectado al canal correcto para que los termostatos controlen los circuitos correctos.  Conecte solo un actuador para cada canal. Los canales 01 y 02 tienen dos salidas (a y b) para dos actuadores.
	<b>Precaución:</b> Si el sistema cuenta con más de una unidad base disponible, registre el termostato como un dispositivo de sistema a la unidad base principal.
	<b>Precaución:</b> Los interruptores del termostato público se deben ajustar antes de registrar el termostato.
	<b>Precaución:</b> Los interruptores del termostato público se deben ajustar a una de las funciones disponibles, o no podrán ser registrados.
	<b>NOTA:</b> Es necesario registrar al menos un termostato antes de registrar un dispositivo de sistema.



## FI Turvallisuusohjeet









Tämä pikaopas on tarkoitettu kokeneiden asentajien muistin tueksi. Suosittelemme varsinaisen ohjekirjan lukemista ennen säätöjärjestelmän asennusta.

	<b>Vaara!</b> Uponor-järjestelmä käyttää 230 V AC, 50 Hz -jännitettä. Häätötilanteessa virransyöttö on katkaistava välittömästi.
	<b>Vaara!</b> Suljettujen 230 V AC -suojakoteloiden takana olevien komponenttien asennus- ja huoltotöitä saa tehdä vain ammattitaitoinen sähköasentaja.
	<b>Vaara!</b> Muuntajamoduuli on raskas ja saattaa irrota, jos keskusyksikköä pidetään ylösalaisin ilman suojakoteloä.
	<b>Varoitus!</b> Häiriöiden välttämiseksi liitäntä-/datakaapelit on pidettävä erillään yli 50 V:n virtajohdoista.
	<b>Varoitus!</b> Jos yhteysongelmia esiintyy, suosittelemme antennin siirtämistä parempaan paikkaan ja välttämään Uponor-radioyksiköiden sijoittamista lähemmäksi ( <b>välillä oltava vähintään 40 cm</b> ) näiden harvoin ilmenevien ongelmien ratkaisemiseksi.
	<b>Varoitus!</b> Varmista, että kaikki toimilaitteet on liitetty oikeisiin kanaviin niin, että termostaatit säättävät oikeita piirejä.  Liitä kuhunkin kanavaan vain yksi toimilaite. Kanavissa 01 ja 02 on kaksi lähtöliitäntää (a ja b) kahdelle toimilaitteelle.
	<b>Varoitus!</b> Jos järjestelmässä on useita keskusyksiköitä, termostaatti rekisteröidään järjestelmälaitteeksi pääkeskusyksikköön.
	<b>Varoitus!</b> Julkisten tilojen termostaattien kytkimet on asetettava ennen termostaatin rekisteröintiä.
	<b>Varoitus!</b> Julkisten tilojen termostaattien kytkimiin on asetettava jokin käytettävissä olevista toiminnoista. Muussa tapauksessa termostaatin rekisteröinti ei onnistu.
	<b>HUOMAUTUS!</b> Ennen järjestelmälaitteen rekisteröintiä järjestelmään on rekisteröitävä vähintään yksi termostaatti.

## FR Consignes de sécurité





Cette notice est un guide de démarrage rapide destiné à servir de rappel pour les installateurs chevronnés. Uponor vous recommande fortement de lire tout le manuel avant d'installer le système de régulation.







	<b>Avertissement !</b> Le système Uponor fonctionne avec du courant 50 Hz, 230 V CA. En cas d'urgence, couper immédiatement le courant.
	<b>Avertissement !</b> Les services et installations électriques situés derrière des capots à 230 V CA doivent être réalisés sous la supervision d'un électricien qualifié.

	<b>Avertissement !</b> Le module transformateur est lourd et peut se détacher si la centrale de régulation est tenue à l'envers sans le capot.
	<b>Attention !</b> Afin d'éviter les interférences, poser les câbles de l'installation à l'écart des câbles d'alimentation véhiculant une tension supérieure à 50 V.
	<b>Attention !</b> En cas de difficultés de communication, Uponor recommande de replacer l'antenne dans une position plus optimale et de ne pas installer les sources radio d'Uponor trop près les unes des autres ( <b>au moins 40 cm</b> ), afin de résoudre les problèmes exceptionnels.
	<b>Attention !</b> S'assurer que chaque actionneur est connecté au bon canal afin que les thermostats contrôlent les bons circuits.  Ne connecter qu'un seul actionneur pour chaque canal. Les canaux 01 et 02 ont des sorties doubles (a et b) pour deux actionneurs.
	<b>Attention !</b> Si plus d'une centrale de régulation est disponible dans le système, affecter le thermostat en tant que composant du système à la centrale de régulation maître.
	<b>Attention !</b> Les commutateurs du thermostat public doivent être réglés avant l'affectation du thermostat.
	<b>Attention !</b> Les commutateurs du thermostat public doivent être réglés sur les fonctions disponibles, sans quoi celui-ci ne peut pas être affecté.
	<b>REMARQUE !</b> Au moins un thermostat doit être affecté avant d'affecter un composant du système.

## HR Sigurnosne upute



Ovaj vodič za brzo postavljanje služi kao podsjetnik za iskusne instalatere. Preporučujemo da pročitate cijeli priručnik prije instalacije kontrolnog sustava.





	<b>Upozorenje!</b> Sustav Uponor koristi se izmjeničnom strujom frekvencije 50 Hz i napona od 230 V. U hitnim slučajevima odmah isključite napajanje.
	<b>Upozorenje!</b> Električna instalacija i usluge iza osiguranih poklopaca za izmjeničnu struju napona od 230 V moraju se obaviti pod nadzorom kvalificiranoga električara.
	<b>Upozorenje!</b> Modul transformatora težak je i može se odvojiti ako se regulator drži naopako bez poklopca.
	<b>Oprez!</b> Da biste izbjegli interferenciju, držite instalacijske/podatkovne kabele dalje od kabela za napajanje napona većeg od 50 V.

	<b>Oprez!</b> Ako postoje poteškoće u komunikaciji, Uponor preporučuje premještanje antene na bolje mjesto i izbjegavanje postavljanja izvora radijskog signala Uponor preblizu jedan drugome ( <b>minimalno 40 cm</b> ) za rješavanje iznimnih problema.
	<b>Oprez!</b> Provjerite je li svaki elektro termički pogon povezan na ispravni kanal tako da termostati upravljaju ispravnim krugovima.  Povežite samo jedan elektro termički pogon za svaki kanal. Kanali 01 i 02 imaju dvostruke izlaze (a i b) za dva elektro termička pogona.
	<b>Oprez!</b> Ako je u sustavu dostupno više regulatora, registrirajte termostat kao sistemski uređaj glavnog regulatora.
	<b>Oprez!</b> Prekidači na javnom termostatu moraju se postaviti prije nego što se termostat registrira.
	<b>Oprez!</b> Prekidači na javnom termostatu moraju se postaviti na jednu od dostupnih funkcija ili se neće moći registrirati.
	<b>NAPOMENA!</b> Prije registracije sistemskog uređaja mora se registrirati barem jedan termostat.

## HU Biztonsági utasítások





Ez a rövid szerelési útmutató tapasztalt szerelők részére szolgáló emlékeztető. Kifejezetten javasoljuk, hogy a vezérlőrendszer szerelése előtt ne csak ezt a rövid útmutatót, hanem a részletes kézikönyvet is olvassa el.

	<b>Vigyázat!</b> Az Uponor rendszere 230 V-os, 50 Hz-es váltóáramot használ. Veszély esetén azonnal szüntesse meg a tápellátást.
	<b>Vigyázat!</b> A 230 V-os váltóáram ellen védő biztonsági burkolat mögött villanszerelést és ehhez kapcsolódó szolgáltatást szakképzett villanszerelő felügyelete mellett kell végezni.
	<b>Vigyázat!</b> Az átalakító modul nagy tömegű, ezért ha a vezérlőegységet fejjel lefelé, burkolat nélkül tartja, leválhat.
	<b>Figyelem!</b> Az interferencia elkerülése érdekében az üzembe helyezéshez használt kábeleket vagy adatkábeleket tartsa távol az 50 V-nál magasabb feszültségű kábelektől.
	<b>Figyelem!</b> Az Uponor javasolja, hogy adatátviteli nehézségek esetén az antennát helyezték jobb vételi pontra, valamint a különleges problémák elkerülése végett az Uponor rádióforrásait ne egymáshoz közel állítsák fel: <b>legyen közöttük legalább 40 cm távolság.</b>

	<b>Figyelem!</b> Győződjön meg arról, hogy mindegyik állásszabályozó a megfelelő csatornába van kötve, hogy a termostátok a megfelelő köröket vezéreljék.  Egy csatornába csak egy állásszabályozó köthető. Az 01. és a 02. csatornának dupla kimenete („a” és „b”) van, két-két állásszabályozó használható velük.
	<b>Figyelem!</b> Ha a rendszer egynél több vezérlőegységet tartalmaz, a termostátot a fő vezérlőegységen rendszerkészülékként kell regisztrálni.
	<b>Figyelem!</b> A közületi termostátat kapcsolóit a termostát regisztrálása előtt be kell állítani.
	<b>Figyelem!</b> A közületi termostátat kapcsolóinak regisztrálása csak akkor végezhető el, ha a rendelkezésre álló funkciók valamelyikére vannak beállítva.
	<b>MEGJEGYZÉS</b> A rendszerkészülék regisztrációja előtt legalább egy termostát regisztrációját el kell végezni.

## IT Istruzioni di sicurezza

Questa Guida rapida rappresenta un promemoria per gli installatori esperti. Si raccomanda di leggere attentamente tutto il manuale prima di installare il sistema di controllo.

	<b>Avvertenza!</b> Il sistema Uponor è alimentato a 230 V c.a., 50 Hz. In caso di emergenza, scollegare immediatamente l'alimentazione.
	<b>Avvertenza!</b> I collegamenti elettrici e gli interventi di assistenza dietro gli scomparti 230 V c.a. devono essere effettuati sotto la supervisione di un elettricista qualificato.
	<b>Avvertenza!</b> Il modulo trasformatore è pesante e può staccarsi se l'unità base viene capovolta senza coperchio.
	<b>Attenzione!</b> Per evitare interferenze, tenere i cavi di installazione/dati lontano dai cavi di alimentazione superiori a 50 V.
	<b>Attenzione!</b> In caso di difficoltà di comunicazione, Uponor raccomanda di spostare l'antenna e di non installare le fonti di segnali radio Uponor troppo vicine tra loro ( <b>almeno 40 cm</b> ).
	<b>Attenzione!</b> Accertarsi che ogni attuatore sia collegato al canale corretto affinché i termostati controllino i circuiti corretti.  Collegare solamente un attuatore per canale. I canali 01 e 02 prevedono due uscite (a e b) per due attuatori.
	<b>Attenzione!</b> Qualora il sistema comprenda più unità base, registrare il termostato come dispositivo di sistema all'unità base master.
	<b>Attenzione!</b> Gli interruttori nel termostato pubblico devono essere impostati prima della registrazione.

	<b>Attenzione!</b> Gli interruttori nel termostato pubblico devono essere impostati su una delle funzioni disponibili, altrimenti non può essere registrato.
---	---

	<b>NOTA!</b> Prima di registrare un dispositivo di sistema deve essere completata la registrazione di almeno un termostato.
---	--

## LT Saugos instrukcijos

Ši trumpa instrukcija yra kaip priminimas patyrusiems montuotojams. Pritygtinai rekomenduojame prieš montuojant valdymo sistemą perskaityti išsamias instrukcijas.

	<b>Perspėjimas!</b> „Uponor“ sistema naudoja 50 Hz, 230 V kintamosios srovės maitinimo tiekimą. Avariniu atveju nedelsiant atjunkite maitinimą.
---	--

	<b>Perspėjimas!</b> Elektros įrangos montavimo ir techninės priežiūros darbus už saugomų 230 V kintamosios srovės dangčių būtina vykdyti prižiūrint kvalifikuotam elektrikui.
---	--

	<b>Perspėjimas!</b> Transformatoriaus modulis yra sunkus ir gali atsikabinti, jei valdiklis bus laikomas apverstas ir be dangčio.
---	--

	<b>Įspėjimas!</b> Kad išvengtumėte trikdžių, laikykite montavimo / duomenų laidus atokiau nuo maitinimo laidų, kurių įtampa siekia daugiau nei 50 V.
--	---

	<b>Įspėjimas!</b> Išskirtiniais atvejais, jei yra ryšio problemų, „Uponor“ rekomenduoja pakeisti antenas vietą į geresnę padėtį ir nemontuoti „Uponor“ radijo šaltinių per daug arti vienas kito ( <b>mažiausias atstumas – 40 cm</b> ).
---	---

	<b>Įspėjimas!</b> Įsitikinkite, kad kiekviena pavara prijungta prie tinkamo kanalo, kad termostatai valdytų tinkamus kontūrus.  Prie vieno kanalo junkite tik vieną pavara. 01 ir 02 kanalai turi dvigubas išvestis (a ir b) dviems pavaroms.
---	--

	<b>Įspėjimas!</b> Jei sistemoje yra daugiau kaip vienas valdiklis, termostatą užregistruokite kaip sistemos įrenginį pagrindiniam valdikliui.
---	--

	<b>Įspėjimas!</b> Jungiklius viešųjų patalpų termostate būtina nustatyti prieš registruojant termostatą.
---	---

	<b>Įspėjimas!</b> Viešųjų patalpų termostate jungikliai turi būti nustatyti į vieną iš galimų funkcijų, kad būtų galima jį užregistruoti.
---	--

	<b>PASTABA!</b> Prieš registruojant sistemos įrenginį, turi būti užregistruotas bent vienas termostatas.
---	---

## LV Drošības noteikumi

Šajā Tsajā darba sākšanas rokasgrāmatā ir apkopoti atgādinājumi pieredzējušiem uzstādītājiem. Pirms kontroles sistēmas uzstādīšanas īpaši ieteicams izlasīt pilno rokasgrāmatu.

	<b>Brīdinājums!</b> Uponor sistēmai tiek lietota 50 Hz, 230 V maiņstrāvas elektropadeve. Ārkārtas situācijā nekavējoties atvienojiet elektropadevi.
---	--

	<b>Brīdinājums!</b> Elektroinstalācijas un apkopes darbus zem pārsegim, kas pasargā no 230 V maiņstrāvas, jāveic kvalificēta elektromontiera uzraudzībā.
---	---

	<b>Brīdinājums!</b> Transformatora modulis ir smags un var atdalīties, ja vadības bloks tiek turēts ar augšpusi uz leju bez vāka.
---	--

	<b>Uzmanību!</b> Lai novērstu traucējumus, turiet instalācijas/datu kabelus atstatus no strāvas vadiem, kuru spriegums pārsniedz 50 V.
---	---

	<b>Uzmanību!</b> Lai novērstu nopietnus sakaru traucējumus, uzņēmums Uponor iesaka pārvietot antenu optimālākā pozīcijā, kā arī neuzstādīt Uponor radio avotus tuvu vienu otram ( <b>jābūt vismaz 40 cm atstatumam</b> ).
---	--

	<b>Uzmanību!</b> Pārliecinieties, ka katrs aktuators ir pievienots pareizajam kanālam, nodrošinot, ka termostati kontrolē atbilstošos kontūrus.  Katram kanālam pievienojiet tikai vienu aktuatoru. 01. un 02. kanālam ir dubulta izeja (a un b) diviem aktuatoriem.
--	---

	<b>Uzmanību!</b> Ja sistēmā ir pieejama vairāk nekā viena kontroles ierīce, reģistrējiet termostatu galvenajā kontroles ierīcē kā sistēmas ierīci.
---	---

	<b>Uzmanību!</b> Sabiedrisko telpu termostata slēdži ir jāuzstāda, pirms termostats tiek reģistrēts.
---	---









	<b>Uzmanību!</b> Sabiedrisko telpu termostata slēdži ir jāiestata vienā no pieejamajām funkcijām, pretējā gadījumā termostatu nevar reģistrēt.
---	---

	<b>PIEZĪME.</b> Pirms sistēmas ierīces reģistrēšanas ir jāveic vismaz viena termostata reģistrēšana.
---	---

## NL Veiligheidsvoorschriften



Deze snelstartgids is bedoeld als geheugensteun voor ervaren installateurs. Wij adviseren u met klem om de volledige handleiding door te lezen voordat u het regelsysteem installeert.







	<b>Waarschuwing</b> Het Uponor-systeem werkt op 230VAC/50Hz-voeding. Trek in een noodgeval onmiddellijk de stekker uit het stopcontact.
---	--

	<b>Waarschuwing</b> Elektrische installatie- en servicewerkzaamheden achter de afgesloten 230 V AC afdekking dienen onder toezicht van een bevoegde electricien te gebeuren.
	<b>Waarschuwing</b> De transformatormodule is zwaar en kan loskomen als de regelmodule ondersteboven wordt gehouden zonder dat de afdekking gemonteerd is.
	<b>Voorzichtig!</b> Zorg er, ter voorkoming van interferentie, voor dat installatie-/datakabels uit de buurt blijven van stroomkabels met meer dan 50 V.
	<b>Voorzichtig!</b> Als de communicatieproblemen niet verdwijnen, raadt Uponor aan om de antenne op een betere positie te plaatsen en de Uponor radiobronnen niet te dicht bij elkaar te installeren ( <b>minimumafstand 40 cm</b> ).
	<b>Voorzichtig!</b> Zorg ervoor dat elke thermische aandrijving is aangesloten op het juiste kanaal, zodat de ruimtethermostaten de juiste groepen aansturen.  Sluit slechts één thermische aandrijving aan voor elk kanaal. Kanalen 01 en 02 hebben dubbele uitgangen (a en b) voor twee thermische aandrijvingen.
	<b>Voorzichtig!</b> Als er meer dan één regelmodule in het systeem aanwezig is, registreer de ruimtethermostaat dan op de master-regelmodule als een systeemapparaat.
	<b>Voorzichtig!</b> De DIP-switch in de openbare ruimtethermostaat moet worden ingesteld voordat de ruimtethermostaat wordt geregistreerd.
	<b>Voorzichtig!</b> De DIP-switch in de openbare ruimtethermostaat moet ingesteld worden op een van de beschikbare functies, anders kan de ruimtethermostaat niet worden geregistreerd.
	<b>LET OP!</b> Ten minste één ruimtethermostaat dient te worden geregistreerd voordat u een systeemapparaat registreert.

## NO Sikkerhetsinstrukser





Dette er en hurtigveiledning som skal fungere som en påminnelse for erfarne montører. Vi anbefaler på det sterkeste at hele bruksanvisningen leses før kontrollsystemet installeres.

	<b>Advarsel!</b> Uponor-systemet bruker 50 Hz, 230 V vekselstrøm. Hvis det oppstår en nødssituasjon, må strømmen kobles fra umiddelbart.
	<b>Advarsel!</b> Elektrisk installasjon og service av 230 V AC-anlegg må utføres av elektriker.
	<b>Advarsel!</b> Transformatoren er tung og kan løsne hvis sentralenheten holdes opp-ned uten deksel.





	<b>Forsiktig!</b> For å unngå forstyrrelser må installasjons-/datakabler ikke ligge i nærheten av strømkabler som fører mer enn 50 V.
	<b>Forsiktig!</b> Hvis det oppstår kommunikasjonsproblemer, anbefaler Uponor å flytte antennen til et mer optimalt sted, og å ikke montere Uponor-radiokilder for nær hverandre ( <b>minst 40 cm avstand</b> ), for å løse eksepjonelle problemer.
	<b>Forsiktig!</b> Påse at hver aktuator er koblet til riktig kanal, slik at termostaten styrer de rette sløyfene.  Koble kun til én aktuator per kanal. Kanal 01 og 02 har doble utganger (a og b) for to aktuatorer.
	<b>Forsiktig!</b> Hvis det er mer enn én sentralenhet i systemet, må termostaten registreres som en systemenhet i hovedsentralenheten.
	<b>Forsiktig!</b> Bryterne i termostaten for offentlig miljø må stilles inn før termostaten registreres.
	<b>Forsiktig!</b> Bryterne i termostaten for offentlig miljø må stilles til én av de tilgjengelige funksjonene, hvis ikke kan den ikke registreres.
	<b>MERK!</b> Det må registreres minst én termostat før en systemenhet kan registreres.

## PL Przepisy dotyczące bezpieczeństwa

Niniejszy krótki przewodnik stanowi przypomnienie dla doświadczonych instalatorów. Stanowczo zalecamy przeczytanie całej instrukcji przed montażem systemu sterowania.







	<b>Ostrzeżenie!</b> System Uponor jest zasilany prądem zmiennym o napięciu 230 V i częstotliwości 50 Hz. W razie zagrożenia należy natychmiast wyłączyć zasilanie.
	<b>Ostrzeżenie!</b> Montaż instalacji elektrycznej i serwis elementów znajdujących się pod zabezpieczającymi pokrywami 230 V AC należy przeprowadzać pod nadzorem wykwalifikowanego elektryka.
	<b>Ostrzeżenie!</b> Transformator jest ciężki i może się oderwać, jeżeli sterownik bez pokrywy trzymany będzie do góry nogami.
	<b>Przestroga!</b> Aby zapobiec zakłóceniom, kable instalacyjne i kable przesyłu danych należy poprowadzić z dala od kabli zasilania, w których napięcie przekracza 50 V.
	<b>Przestroga!</b> W razie wystąpienia trudności z komunikacją firma Uponor zaleca bardziej optymalne umiejscowienie anteny oraz nieinstalowanie źródeł sygnału radiowego Uponor zbyt blisko siebie ( <b>odległość między nimi powinna być nie mniejsza niż 40 cm</b> ), aby rozwiązać wyjątkowe problemy.







	<b>Przeostoga!</b> Aby termostaty sterowały prawidłowymi pętlami, należy upewnić się, że każdy siłownik jest podłączony do właściwego kanału.  Do każdego kanału należy podłączyć tylko jeden siłownik. Kanały 01 i 02 mają podwójne wyjścia (a i b) na dwa siłowniki.
	<b>Przeostoga!</b> Jeżeli w systemie dostępny jest więcej niż jeden sterownik, należy zarejestrować termostat jako urządzenie systemowe nadrzędnego sterownika.
	<b>Przeostoga!</b> Przed zarejestrowaniem termostatu public należy ustawić przełączniki w termostacie public.
	<b>Przeostoga!</b> Przełączniki w termostacie public muszą być ustawione na jedną z dostępnych funkcji; w przeciwnym razie termostatu nie można zarejestrować.
	<b>UWAGA!</b> Przed rejestracją urządzenia systemowego należy zarejestrować co najmniej jeden termostat.

## PT Instruções de segurança









Este guia de início rápido servirá de recurso a instaladores experientes. Recomendamos vivamente que leia o manual na íntegra antes de instalar o sistema de controlo.

	<b>Aviso!</b> O sistema Uponor utiliza uma alimentação de 50 Hz, 230 V CA. Em caso de emergência, desligue imediatamente a alimentação elétrica.
	<b>Aviso!</b> A instalação elétrica e a manutenção de componentes localizados no interior de coberturas de 230 V CA fechadas têm de ser executadas sob supervisão de um electricista qualificado.
	<b>Aviso!</b> O módulo do transformador é pesado e poderá soltar-se se o controlador for virado ao contrário sem a capa.
	<b>Cuidado!</b> Para evitar interferências, mantenha os cabos de instalação/dados afastados dos cabos de alimentação com uma tensão superior a 50 V.
	<b>Cuidado!</b> Se existirem dificuldades de comunicação, a Uponor recomenda que mude a antena para uma posição mais adequada e que não instale fontes de rádio Uponor muito perto umas das outras ( <b>mantenha uma distância mínima de 40 cm</b> ), para resolver problemas excecionais.
	<b>Cuidado!</b> Certifique-se de que cada atuador é ligado ao canal correto, para que os termostatos estejam a controlar os circuitos corretos.  Ligue apenas um atuador para cada canal. Os canais 01 e 02 têm saídas duplas (a e b) para dois atuadores.

	<b>Cuidado!</b> Se existir mais de um controlador disponível no sistema, registre o termostato como dispositivo do sistema no controlador principal.
	<b>Cuidado!</b> Os comutadores no termostato público têm de ser definidos antes do registo do termostato.
	<b>Cuidado!</b> Os comutadores no termostato público têm de ser definidos para uma das funções disponíveis; caso contrário, este não poderá ser registado.
	<b>NOTA!</b> Tem de registar pelo menos um termostato antes de registar um dispositivo do sistema.

## RO Instrucțiuni de siguranță

Acest ghid rapid de punere în funcțiune servește drept memento pentru instalatorii cu experiență. Recomandăm insistent citirea întregului manual înainte de instalarea sistemului de comandă.

	<b>Avertisment!</b> Sistemul Uponor se alimentează cu curent alternativ de 230 V, la 50 Hz. În caz de urgență, deconectați imediat alimentarea electrică.
	<b>Avertisment!</b> Instalarea și revizia sistemelor electrice prevăzute cu capace de siguranță la 230 V CA trebuie să se efectueze sub supravegherea unui electrician calificat.
	<b>Avertisment!</b> Modulul transformatorului este greu și se poate desprinde dacă unitatea de comandă este ținută în poziție răsturnată fără a avea capacul montat.
	<b>Atenție!</b> Pentru a evita interferențele, țineți cablurile de joasă tensiune/date la distanță față de cele electrice mai mari de 50 V.
	<b>Atenție!</b> Dacă există dificultăți de comunicații, Uponor recomandă mutarea antenei într-o poziție mai bună și evitarea instalării surselor radio Uponor prea aproape una de cealaltă ( <b>la distanță de minimum 40 cm</b> ), pentru remediarea problemelor neobișnuite.
	<b>Atenție!</b> Asigurați-vă că fiecare element de acționare (actuador) este conectat la canalul corect, astfel încât termostatele să controleze circuitele corecte.  Conectați un singur element de acționare (actuador) pentru fiecare canal. Canalele 01 și 02 au ieșiri duble (a și b), pentru două elemente de acționare (actuatoare).
	<b>Atenție!</b> Dacă există mai mult de o unitate de comandă în sistem, înregistrați termostatul ca dispozitiv de sistem pe unitatea de comandă principală.
	<b>Atenție!</b> Comutatoarele termostatului public se setează înainte de înregistrarea termostatului.





	<b>Atenție!</b> Comutatoarele termostatului public se setează pe una dintre funcțiile disponibile, în caz contrar acesta nu se poate înregistra.
---	---

	<b>NOTĂ!</b> Înainte de înregistrarea unui dispozitiv de sistem, trebuie să fie înregistrat cel puțin un termostat.
---	--

## RU Инструкции по технике безопасности

Это краткое руководство по запуску служит памяткой для опытных специалистов по установке. Перед установкой системы управления настоятельно рекомендуется ознакомиться с полным руководством.

	<b>Предупреждение</b> Система Uponor питается от сети переменного тока с характеристиками 230 В, 50 Гц. В аварийной ситуации немедленно отключите электропитание.
---	--

	<b>Предупреждение</b> Электромонтаж и обслуживание под крышками в отсеках с напряжением 230 В пер. тока должны выполняться под контролем квалифицированного электрика.
---	---

	<b>Предупреждение</b> Модуль трансформатора тяжелый и может отсоединиться, если перевернуть контроллер со снятой крышкой.
--	--

	<b>Внимание!</b> Во избежание помех не прокладывайте монтажные кабели и кабели передачи данных рядом с силовыми кабелями с напряжением более 50 В.
---	---

	<b>Внимание!</b> Для решения проблем со связью Uponor рекомендует переместить антенну в более подходящее место, а также не устанавливать источники радиоизлучения Uponor слишком близко друг от друга ( <b>минимальное расстояние 40 см</b> ).
---	---

	<b>Внимание!</b> Каждый исполнительный механизм должен подключаться к соответствующему каналу, чтобы термостаты контролировали нужные контуры.  К каждому каналу подсоединяется только один исполнительный механизм. Каналы 01 и 02 имеют двойные выходы (a и b) для двух исполнительных механизмов.
---	---

	<b>Внимание!</b> Если в системе несколько контроллеров, то термостат регистрируется как системное устройство на главном контроллере.
---	---

	<b>Внимание!</b> Переключатели в термостате Public должны быть установлены до регистрации термостата.
---	--

	<b>Внимание!</b> Переключатели в термостате общественного назначения должны быть установлены на одну из имеющихся функций, в противном случае регистрация невозможна.
---	--

	<b>ПРИМЕЧАНИЕ</b> Перед регистрацией системного устройства необходимо зарегистрировать хотя бы один термостат.
---	---

## SE Säkerhetsföreskrifter

Det här är en snabbstartguide som kan användas som minneslista av erfarna installatörer. Vi rekommenderar att du läser igenom hela handboken innan du installerar reglersystemet.

	<b>Varning!</b> Uponor-systemet drivs med elström 50 Hz, 230 V AC. Slå omedelbart ifrån spänningen vid nödsituationer.
---	---

	<b>Varning!</b> Elektrisk installation och service innanför skyddskåpor där spänningar på 230 V AC finns, måste utföras under överinseende av en behörig elektriker.
---	---

	<b>Varning!</b> Transformatormodulen är tung och kan lossna om regulatorn hålls upp och ned utan locket på.
---	--

	<b>Försiktigt!</b> Undvik störningar genom att separera installations- och datakablar från nätkablar med högre spänning än 50 V.
--	---

	<b>Försiktigt!</b> Om kommunikationsproblem uppstår rekommenderar Uponor att antennen placeras på en bättre plats, och att Uponors radiokällor inte installeras för nära varandra ( <b>minst 40 cm avstånd</b> ), för att lösa problemet.
---	--

	<b>Försiktigt!</b> Kontrollera att varje styrdon ansluts till rätt kanal så att termostaterna styr rätt slingor.  Anslut bara ett styrdon för varje kanal. Kanalerna 01 och 02 har dubbla utgångar (a och b) för två styrdon.
---	--

	<b>Försiktigt!</b> Om fler än en regulator finns tillgänglig i systemet, registrera då termostaten som en systemenhet till masterregulatorn.
---	---











	<b>Försiktigt!</b> Switcharna på termostaten för offentlig miljö måste ställas in innan termostaten registreras.
---	---

	<b>Försiktigt!</b> Switcharna på termostaten för offentlig miljö måste ställas in på en av de tillgängliga funktionerna, annars kan inte termostaten registreras.
---	--

	<b>OBS!</b> Åtminstone en termostat måste registreras innan en systemenhet registreras.
---	--

## SI Varnostna navodila









To je hitri začetni vodič, ki naj služi kot opomnik za izkušene instalaterje. Priporočamo, da pred začetkom montaže preberete celoten priročnik oz. navodila.

	<b>Opozorilo!</b> Uponorjev sistem uporablja 50 Hz, 230 V AC električno napajanje. V primeru nevarnosti takoj prekinite napajanje.
	<b>Opozorilo!</b> Električna dela, ki se opravljajo za varovanjem pokrovom 230 V AC predelka, se morajo izvajati pod nadzorom usposobljenega električarja.
	<b>Opozorilo!</b> Transformatorski modul je težak in lahko izpade iz ležišča, če se priključni modul drži obrnjen na glavo brez montiranega pokrova.
	<b>Pozor!</b> Da se izognete motnjam v delovanju zagotovite, da so instalacijski/podatkovni kabli odmaknjeni od napajalnih kablov, ki imajo napetost večjo od 50 V.
	<b>Pozor!</b> V primeru težav s komunikacijo Uponor priporoča, da prestavite anteno na primernejše mesto, in da Uponorjevih virov radijskih valov ne namestite preblizu skupaj ( <b>narazen morajo biti vsaj 40 cm</b> ). S tem boste lahko odpravili redke težave.
	<b>Pozor!</b> Zagotovite, da je vsak termopogon priključen na pravi kanal, tako da bodo termostati krmilili prave zanke.  Priključite samo en termopogon na posamezen kanal. Kanala 01 in 02 imata dvojna vhoda (a in b) za priključitev dveh termopogonov.
	<b>Pozor!</b> Če je v sistemu na voljo več priključnih modulov, registrirajte termostat, na glavni priključni modul, kot sistemsko napravo.
	<b>Pozor!</b> Konfiguracijska stikala se morajo nastaviti pred registracijo termostata.
	<b>Pozor!</b> Konfiguracijska stikala, pri javnem termostatu, morajo biti nastavljeni na eno od možnih funkcij, v nasprotnem primeru se termostat ne more registrirati.
	<b>ОПОМБА</b> Pred registracijo systemske naprave mora biti registriran vsaj en termostat.

## SK Bezpečnostné pokyny



Tento stručný návod slúži ako pomoc pre skúsených inštalatérov. Dôrazne odporúčame, aby ste si pred montážou ovládacieho systému prečítali celý návod.







	<b>Výstraha!</b> Systém Uponor si vyžaduje napájanie zo siete 230 V AC, 50 Hz. V prípade núdze okamžite odpojte napájanie.
---	---

	<b>Výstraha!</b> Montážne a servisné práce na elektrických systémoch za zabezpečeným krytím proti striedavému prúdu 230 V musia byť vykonané pod dohľadom kvalifikovaného elektrikára.
	<b>Výstraha!</b> Transformátorový modul je ťažký a môže sa uvoľniť, ak ovládač držíte prevrátený bez krytu.
	<b>Upozornenie!</b> Inštaláčne/dátové káble neukladajte do blízkosti napájacích kablov s napätím viac ako 50 V, aby ste predišli interferenciám.
	<b>Upozornenie!</b> Ak sa vyskytnú komunikačné ťažkosti, spoločnosť Uponor odporúča, aby sa anténa presunula na optimálne miesto a aby sa v záujme vyriešenia mimoriadnych problémov neumiestňovali rádiové zdroje Uponor príliš blízko k sebe ( <b>minimum 40 cm</b> ).
	<b>Upozornenie!</b> Uistite sa, že jednotlivé termopohony sú pripojené k správnejmu kanálu tak, že termostaty ovládajú správne okruhy.  Na každý kanál pripojte len jeden termopogon. Kanály 01 a 02 majú dva výstupy („a“, „b“) pre dva termopohony.
	<b>Upozornenie!</b> Ak sú v systéme dostupné aspoň dva ovládače, termostat registrujte na hlavnom ovládači ako systémové zariadenie.
	<b>Upozornenie!</b> Vo verejnom termostate musia byť prepínače nastavené pred registráciou termostatu.
	<b>Upozornenie!</b> Vo verejnom termostate musia byť prepínače nastavené na jednu z dostupných funkcií, v opačnom prípade ich nie je možné registrovať.
	<b>ПОЗНАМКА!</b> Pred registráciou systémového zariadenia je potrebné vykonať registráciu aspoň jedného termostatu.

## UA Техніка безпеки

Цей короткий посібник слугує довідкою для досвідчених монтажників. Ми настійно рекомендуємо прочитати повний посібник перед монтажем системи керування.

	<b>Попередження!</b> Системи Uponor працюють від джерела змінного струму на 230 В, 50 Гц. У разі надзвичайної ситуації негайно вимкніть живлення.
	<b>Попередження!</b> Електромонтаж й обслуговування за захисними кришками для змінного струму 230 В мають виконуватися під наглядом кваліфікованого електрика.
	<b>Попередження!</b> Трансформаторний модуль важкий і може від'єднатися, якщо контролер тримати дотори дном без кришки.

	<p><b>Увага!</b></p> <p>Аби запобігти завадам, тримайте кабелі установок/передачі даних подалі від компонентів, що мають напругу понад 50 В.</p>
	<p><b>Увага!</b></p> <p>Щоб убезпечити себе від ймовірних проблем зі зв'язком, компанія Uponor рекомендує винести антену з колекторної шафи і знайти їй місце розташування без перешкод. Також не встановлюйте радіопристрої Uponor близько одне до одного (<b>мінімальна відстань — 40 см</b>).</p>
	<p><b>Увага!</b></p> <p>Кожен сервопривід має бути під'єднано до відповідного каналу, щоб термостати керували відповідними контурами.</p> <p>До кожного каналу має під'єднуватися лише один сервопривід. Канали 01 і 02 мають подвійні виходи (а і б) для двох виконавчих механізмів.</p>
	<p><b>Увага!</b></p> <p>Якщо в системі доступно більше одного контролера, термостат як системний пристрій, реєструється на головному контролері.</p>
	<p><b>Увага!</b></p> <p>Перемикачі в термостаті загального користування має бути встановлено до реєстрації термостата.</p>
	<p><b>Увага!</b></p> <p>Для перемикачів в термостаті Т-163 має бути встановлено одну з доступних функцій, інакше термостат не можна буде зареєструвати.</p>
	<p><b>Примітка</b></p> <p>Перед реєстрацією системного пристрою має бути зареєстровано принаймні один термостат.</p>

**Uponor GmbH**

Industriestraße 56,  
D-97437 Hassfurt, Germany

1094645 v5\_12\_2024  
Production: Uponor / DCO

Uponor reserves the right to make changes, without prior notification,  
to the specification of incorporated components in line with its policy  
of continuous improvement and development.



[www.uponor.com](http://www.uponor.com)