

GF Building Flow Solutions

Silenta Premium

Product Range



+GF+

+GF+

Contents

Building Technology (BT)
(GF BFS)

Leading with Water ▶ 4

About GF Hakan Plastik ▶ 5

Supply Chain Processes ▶ 6-7

Our Markets ▶ 8-9

About Plastics ▶ 10-11

Quiet Comfort, Proven Performance ▶ 12-13

Worldwide Quality Compliance ▶ 14-15

Silenta Premium ▶ 16-25
Soundproof Pipe Systems

Building Technology (BT) Wastewater Pipe Range Installation Instructions ▶ 26-31

Packaging ▶ 33

Storage ▶ 34

Transportation ▶ 35

Chemical Resistance Tables ▶ 36-47

References ▶ 48-49

Leading with Water

GF Building Flow Solutions

We make water flow in buildings, empowering customers in residential and commercial spaces to boost productivity and sustainability while enhancing comfort, health, and efficiency. Our reliable hot and cold water, waste water, and energy-efficient heating and cooling solutions are available in over 80 countries. Through GF Building Flow Solutions, we bring together two powerful global brands: GF and Uponor.

+ **1.3 bn CHF**

total revenues 2023

+ **> 4'200**

employees worldwide

+ **30**

countries

+ **13**

productions sites



Innovation Champion in sound-proof waste water systems

The GF waste water production sites are pioneers in manufacturing soundproofed pipes. GF Building Flow Solutions continues to be the expert for robust and reliable plastic pipes for waste water application.

**Waste water systems produced to the highest GF standards
– for more than 50 years**

Çerkezköy, TR



Superior Supply Chain Processes

GF Building Flow Solutions, a division of GF, is a leading global provider of sustainable and innovative solutions, making water flow in buildings. The division, stemming from the 2023 acquisition of Uponor by GF, provides safe solutions for hot and cold water supply and control, noise-reducing waste water systems, as well as energy-efficient heating and cooling. Its focus is to enable its customers in the residential and commercial space to be more productive and sustainable, while ensuring comfort, health and efficiency. GF Building Flow Solutions has sales companies in 30 countries and production sites in 13 locations across Europe and the Americas.





Anticipating with expertise and trust

Reliability is essential in waste water management. Our advanced solutions exceed industry expectations. With cutting-edge materials and over 100 years of expertise, we offer systems that are durable, easy to install, and require minimal maintenance. From noise-reducing technology to odor-blocking valves, every feature is designed to enhance com-fort and usability.



Choosing GF Building Flow Solutions means embracing a future where waste water systems are not a challenge – they are a seamless part of modern, comfortable living.



The right choice for speed and excellence

The full GF Building Flow Solutions Waste Water competence

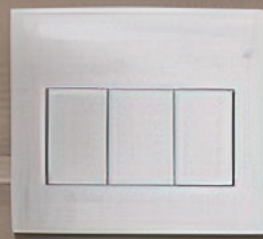



The right solution for every application.

GF Building Flow Solutions Waste Water Systems

In construction, every detail counts. Installers and planners face more than just technical demands when designing drainage systems. Noise, fire safety, and long-term reliability are critical concerns. Buildings need more than efficient solutions; they require systems that guarantee comfort and safety for those who live and work in them.

Turning challenges into comfort

At GF Building Flow Solutions, we understand these challenges. For decades, we've developed waste water systems that go beyond basic functionality. Our solutions reduce noise, improve fire safety, and ensure long-lasting performance. Whether for single-family homes or multi-story buildings, we create systems that ensure peace, quiet, and security for occupants. Our solutions include:

- Acoustic House Drainage
- House Drainage
- Air Admittance Valves
- Drain Inlets

Anticipating with expertise and trust

Reliability is essential in waste water management. Our advanced solutions exceed industry expectations. With cutting-edge materials and over 100 years of expertise, we offer

systems that are durable, easy to install, and require minimal maintenance. From noise-reducing technology to odor-blocking valves, every feature is designed to enhance comfort and usability.

Choosing GF Building Flow Solutions means embracing a future where waste water systems are not a challenge – they are a seamless part of modern, comfortable living.

GF Building Flow Solutions, a division of GF, is a leading global provider of sustainable and innovative solutions, making water flow in buildings. The division, stemming from the 2023 acquisition of Uponor by GF, provides safe solutions for hot and cold water supply and control, noise-reducing waste water systems, as well as energy-efficient heating and cooling. Its focus is to enable its customers in the residential and commercial space to be more productive and sustainable, while ensuring comfort, health and efficiency. GF Building Flow Solutions has sales companies in 30 countries and production sites in 13 locations across Europe and the Americas.

Benefits of Plastics

Plastics are polymers created by the chemical conversion of natural products or synthesized from organic materials. The primary components that make up the building blocks of plastics are long chains of carbon (C) and hydrogen (H) known as monomers.

The raw materials used for the production of plastics are natural compounds such as cellulose, coal, oil and natural gas. In the plastics industry, around 6 % of the petroleum products that come out from refineries is used.

Plastics fall into three main categories on the basis of their internal structure and the resulting mechanical characteristics: thermoplastics, thermosetting plastics and elastomers.

Thermoplastics in turn can be split into two main categories as partially-regular (semi-crystalline) and irregular (amorphous) molecular structures.

Semicrystalline thermoplastics, which have a partially ordered molecular structure: this category includes the polyolefins (polypropylene, polyethylene, polybutylene) and fluoropolymers (PVDF, PTFE, etc.)

Amorphous thermoplastics, which have no crystalline regions and no packed molecular structure: this category includes the vinyl chlorides (PVC- U, PVCC, etc.) and styrenes (ABS, polystyrene, etc.)

Semi crystalline materials are more suitable for hot welding, while amorphous thermoplastics are ideal for cementing or cold welding (solvent cementing).

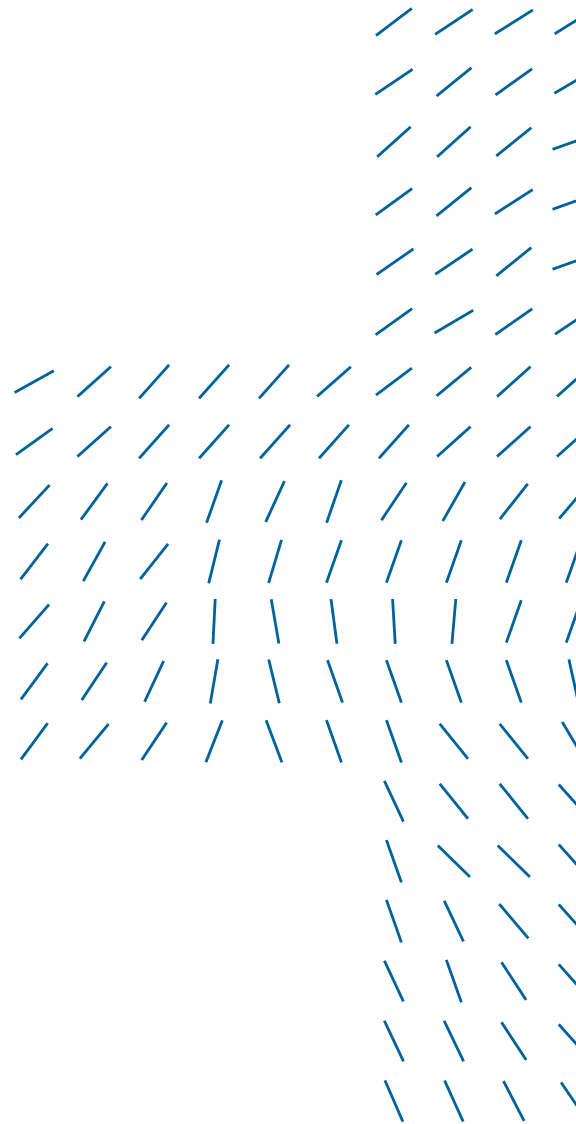

Advantages of Plastic Systems

Thermoplastics obviously demonstrate different characteristics than those of the metals traditionally used for piping.

Metal Systems

High density

- Crane needed for transport
- Widely spaced fixings
- High anchoring forces, fixing required

Thermal conductivity

- Insulation is always needed to limit heat loss
- Formation of condensation and resulting corrosion

Corrosion Behaviors

- Galvanic corrosion may occur
- Internal diameter is reduced due to corrosion
Reduction in internal diameter leads to pressure losses

Chemical resistance

- Low resistance to acids, requiring use of costly alloys
- Damage from incrustation

Plastic Systems

Low density

- Can be carried by hand up to d110
- Closely spaced fixings
- Limited anchoring forces, simple and economic

Low thermal conductivity

- Limited heat loss
- Low levels of condensation and resistance to corrosion

High Corrosion Resistance

- No risk of galvanic corrosion risk
- No corrosion and reduction of internal diameter
No pressure losses due to lack of reduction of internal diameter

High chemical resistance

- * In combination with correct jointing methods, at least 25 years of useful life can be warranted
No incrustation

Service Life Analysis of Plastics

It is the total of all greenhouse gases emitted to the atmosphere during the entire lifetime including the processes for extracting a product having carbon footprint from under the ground, refining, producing, using and disposing of that product.

The following graphics indicate the assessment of the lifetime of thermoplastic piping systems in terms of the quality of their environmental performance and application of them in building technology, industry and water and gas distribution. In the analysis, the impacts of one meter long pipe was compared with the main competitor materials (DN25, DN80, DN150 and DN400) for each of the commonly used plastics. GF supplied this analysis from an independent, Swiss-based organization specialized in environmental performance analyzes, and is based on Ecoinvent, leading lifecycle inventory database in the world.

According to the main results of the study, plastic piping systems demonstrate better performance than metal systems. This finding has been confirmed by other studies conducted in this field.

The main reason for high performance of thermoplastics is that they are lightweight. This ensures key benefits during transport and installation. Fully-plastic solutions are lighter than other piping systems of conventional materials, and this creates significant impacts on carbon footprint.

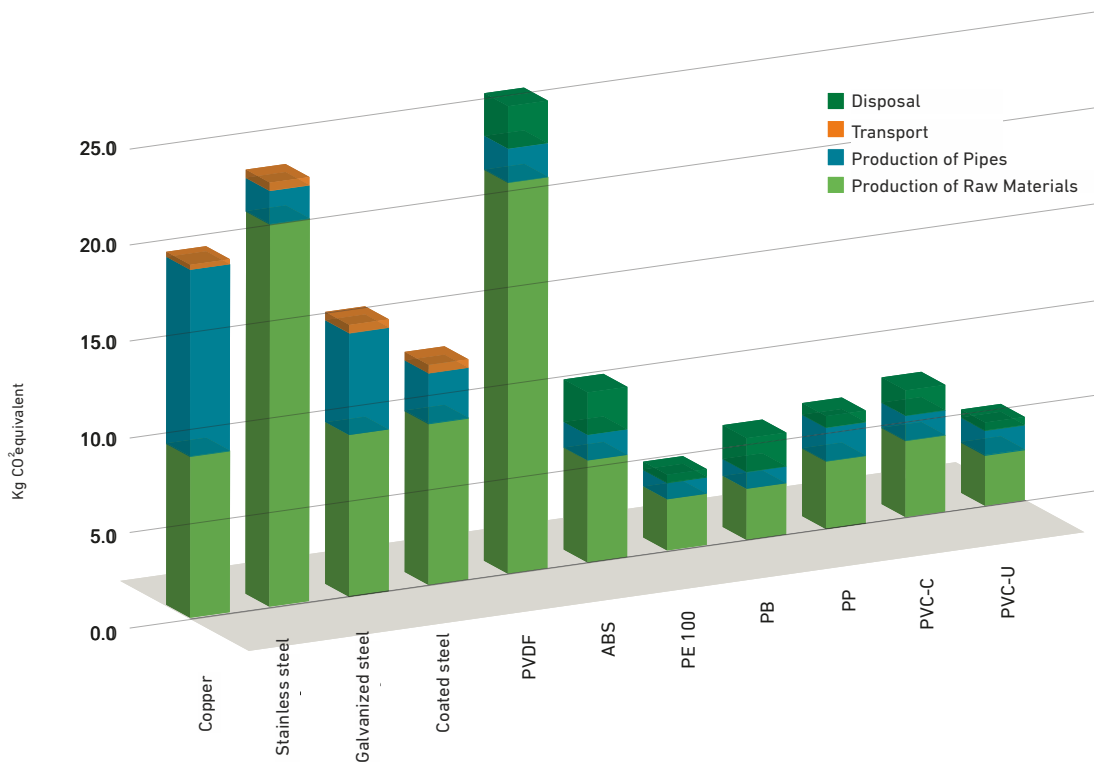

Quiet comfort, proven performance

Waste water disposal can often result in unwanted noise, both structure-borne and air-borne. At GF Building Flow Solutions, we tackle this challenge head-on with our Acoustic In-House Drainage Pipes. Designed to reduce noise at the source, our pipes ensure a quieter, more comfortable living environment. Certified by the Fraunhofer Institute for Building Physics in Stuttgart, our systems deliver top-tier acoustic performance. The graph on this page illustrates the significant reduction in noise levels, highlighting the superior soundproofing of our solutions.

With GF Building Flow Solutions, you choose silence, comfort, and proven quality.

Leader in low noise waste water systems

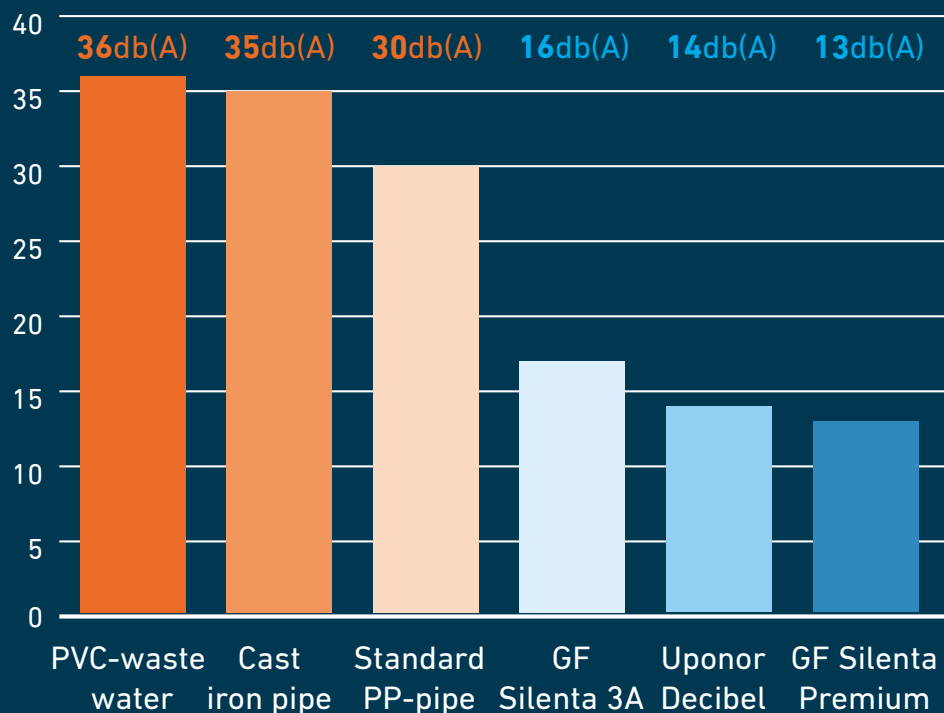



> 50 %
noise reduction vs.
standard PP-pipes

Quality Certificates

Manufacturing its products in accordance with the European standards and Turkish standards equivalent to the European standards, our Company is a leading and dynamic organization in terms of continuous improvement and customer satisfaction.

In addition to product quality, the process and system quality of GF Hakan Plastik is certified by BVQI through TS EN ISO 9001:2015 certificate.

Our Company that places top priority on process and system quality also has TS EN ISO 14001:2015 and TS EN ISO 45001:2018 certificates. Our production plant in Çerkezköy have TS EN ISO/IEC 17024:2012 laboratory.



ISO 9001
BUREAU VERITAS



ISO 14001
BUREAU VERITAS



ISO 45001
BUREAU VERITAS



ISO 50001
BUREAU VERITAS

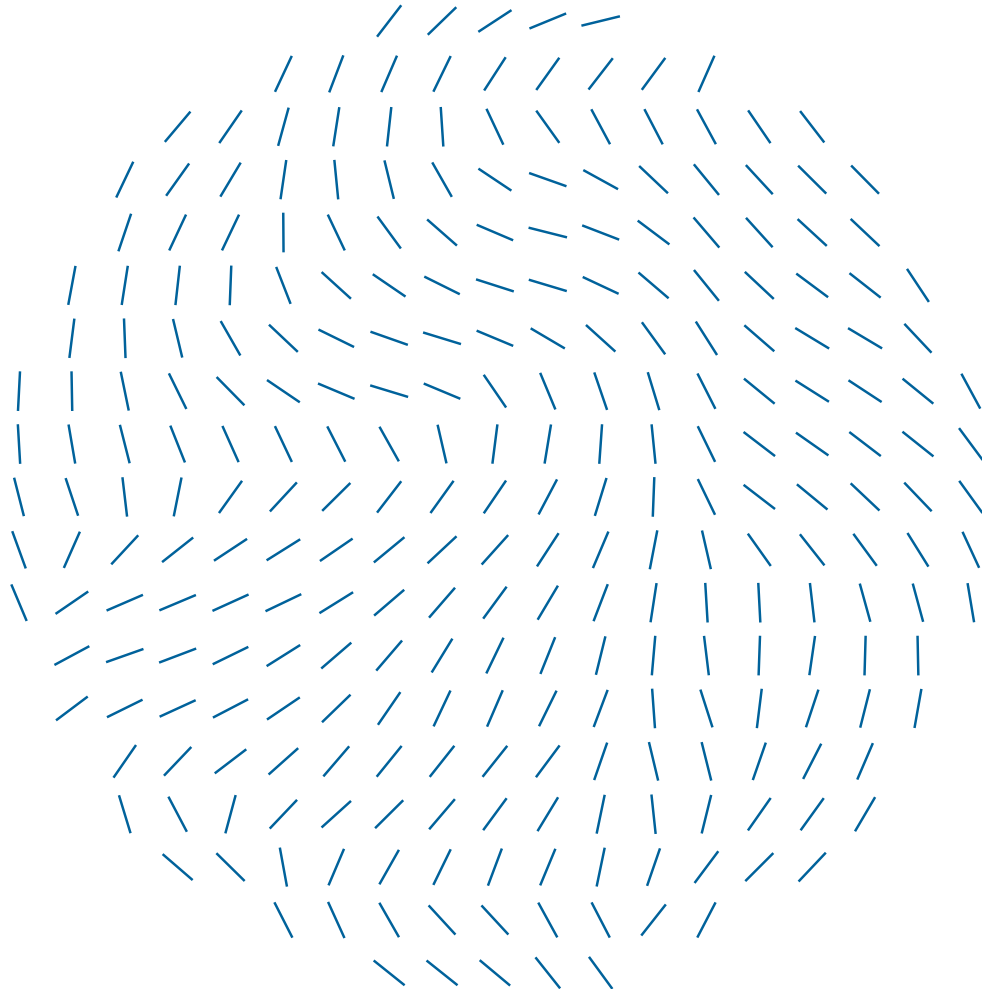

Worldwide Quality Compliance for Silenta Premium

Some certifications around the world



GERMANY
DIBT



GERMANY
SKZ



TÜRKİYE
TSEK



TÜRKİYE
ENVIRONMENTAL
PRODUCT
DECLARATION



GERMANY
HOCH



GERMANY
FRAUNHOFER
INSTITUTE

GF Silenta Premium

Silenta Premium is a sound-insulated, three-layer sewage pipe system made from high-quality PP-material, specifically designed and reinforced for non-pressurized domestic drainage in accordance with the system standards DIN 4109 and DIN 4102. The acoustic performance of Silenta Premium has been accredited by the Fraunhofer Institute in Germany, ensuring exceptional noise reduction. It is ideally suited for hot, cold, and acidic waste water, offering outstanding durability and performance. The system's sturdiness is further enhanced by its impact-resistant design. Available in pipe diameters ranging from 58 mm to 200 mm, Silenta Premium also includes a variety of fittings and accessories, making it a reliable and versatile solution for modern drainage systems.



Features

- Excellent sound insulation
- Flame-retardant
- Halogen-free and no release of toxic gases in event of fire
- Acid-resistant
- Temperature-resistant

Benefits

- High level of comfort
- Extending life cycle of entire system
- Securing safety and health during event of fire

Field of application

Type	Details
Work areas	Office buildings, hospitals, conference halls, etc.
Public domains	Schools, colleges, libraries, community centers, tutoring centers, etc.
Residential buildings	Houses, residences, apartments, hotels, etc.

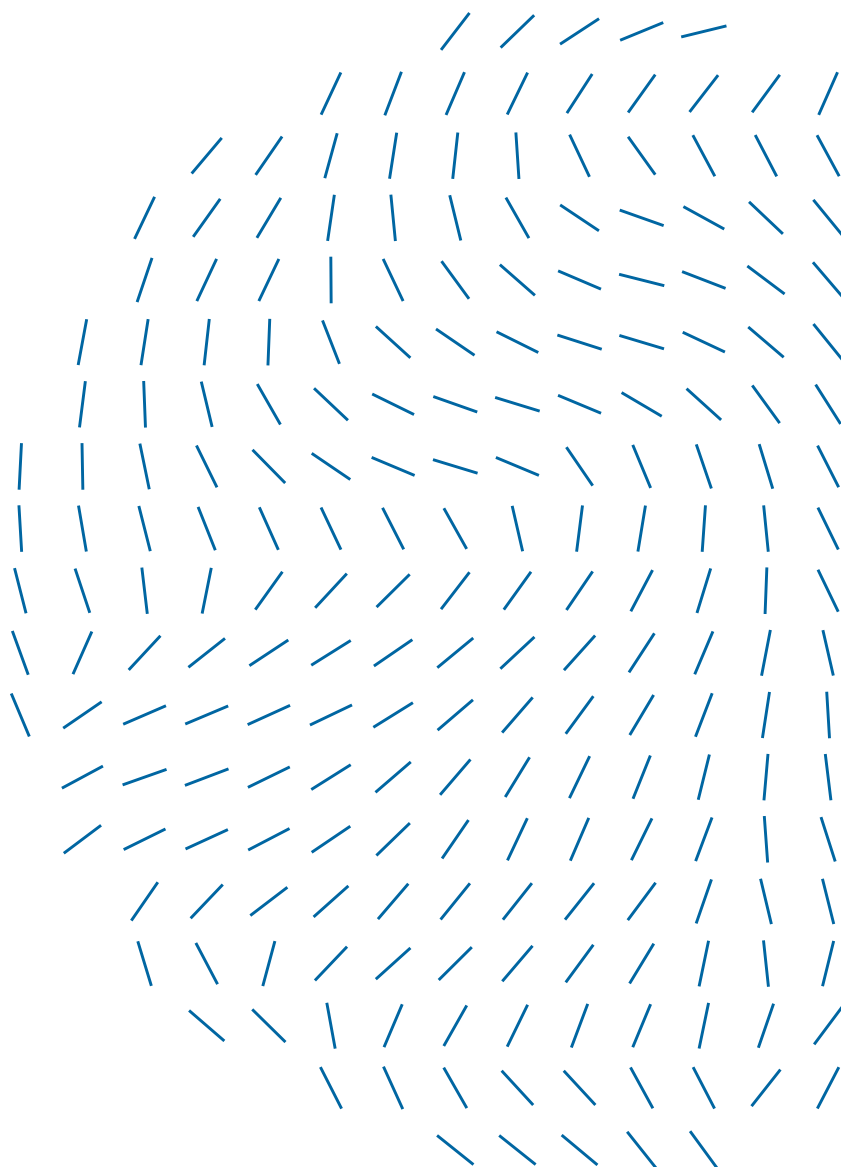

Technical facts

Type	Details
Diameter	Ø 58 mm - Ø 200 mm
Length	0.15mt - 3mt
Color	Light grey
Acoustic performance	13 dB(A) / 4lt/s acc. EN14366
Flammability class	B2 acc. to DIN 4102
Pipes	With and without socket
Standards	DIN 4109, DIN 4102-B2

Superior Sound-Proof Performance

Sound-insulated soil and waste water pipe system **Silenta Premium** guarantees quality, peace of mind and living comfort.

Acoustic performance of Silenta Premium was accredited by the famous German Fraunhofer Institute, in compliance with DIN 4109 and EN 14366.

Noise measurement tests were carried out at Fraunhofer Physical Constructions Institute in Stuttgart, the most accredited European laboratory on noise studies on buildings. The acoustic performance tests were conducted in compliance with the standard DIN EN 14366.

The emitted noise level at **4 l/s** flow rate, with special GF Hakan Silent clamps, is only **13 dB(A)** according to **DIN EN 14366**.

SILENTA PREMIUM ACOUSTIC PERFORMANCE dB(A)

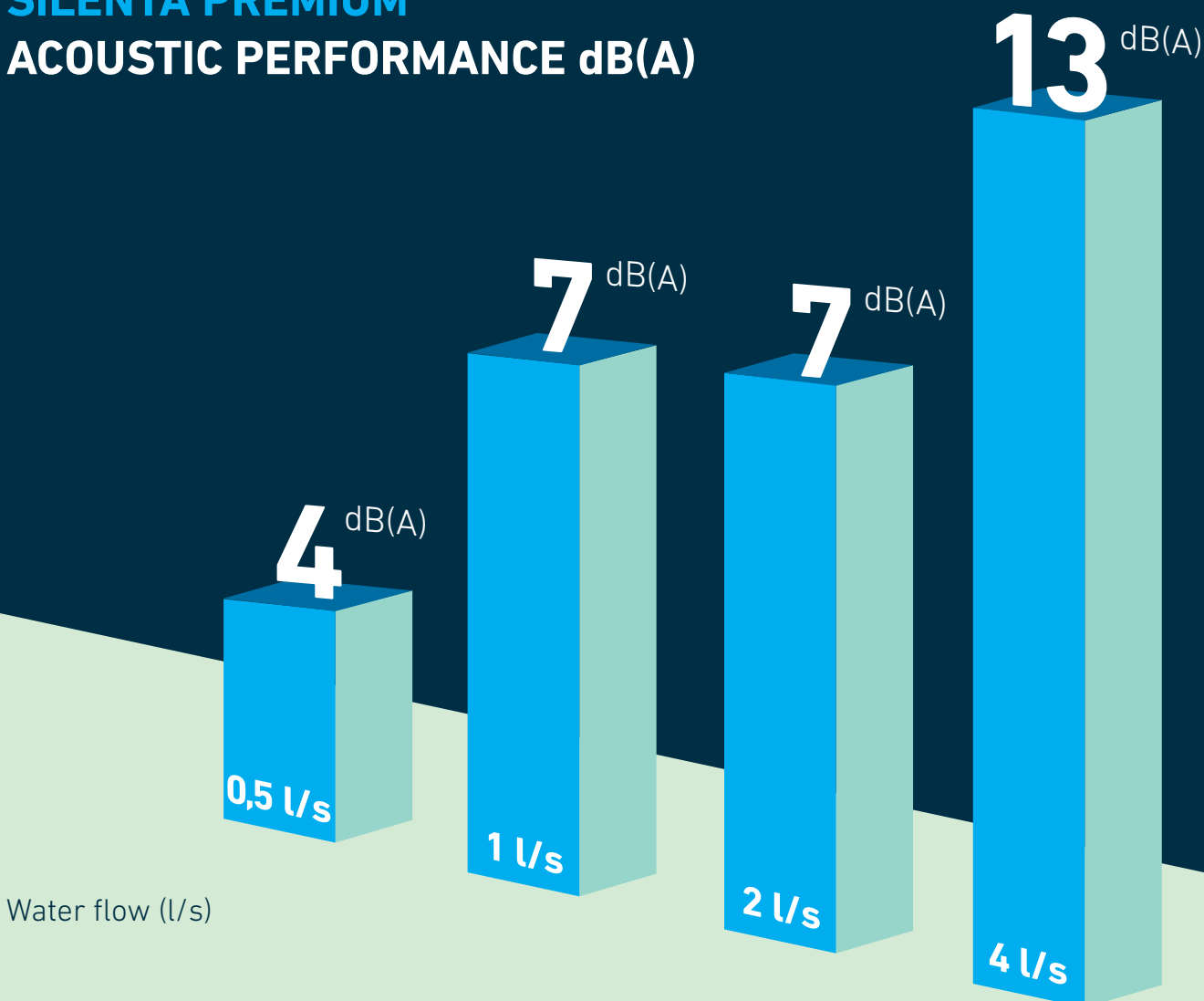

Silenta Premium



Silenta Premium Pipe with Socket

Dia. (mm)	Leng. (mm)	Code	Packing Type	Pc
58	150	4401005801021	Base Box	28
58	250	4401005801121	Base Box	20
58	500	4401005801221	Base Box	30
58	1000	4401005801321	Wodden	114
58	2000	4401005801421	Wodden	114
58	3000	4401005801521	Wodden	114
78	150	4401007805021	Base Box	16
78	250	4401007805121	Base Box	12
78	500	4401007805221	Base Box	16
78	1000	4401007805321	Wodden	70
78	2000	4401007805421	Wodden	70
78	3000	4401007805521	Wodden	70
90	150	4401009005021	Base Box	28
90	250	4401009005121	Base Box	20
90	500	4401009005221	Base Box	12
90	1000	4401009005321	Wodden	60
90	2000	4401009005421	Wodden	60
90	3000	4401009005521	Wodden	60
110	150	4401011005021	Base Box	18
110	250	4401011005121	Base Box	12
110	500	4401011005221	Base Box	8
110	1000	4401011005321	Wodden	40
110	2000	4401011005421	Wodden	40
110	3000	4401011005521	Wodden	40
135	150	4401013506021	Base Box	12
135	250	4401013506121	Base Box	8
135	500	4401013506221	Base Box	5
135	1000	4401013506321	Wodden	24
135	2000	4401013506421	Wodden	24
135	3000	4401013506521	Wodden	24
160	150	4401016007021	Base Box	10
160	250	4401016007121	Base Box	6
160	500	4401016007221	Base Box	4
160	1000	4401016007321	Wodden	21
160	2000	4401016007421	Wodden	21
160	3000	4401016007521	Wodden	21
200	1000	4401020008121	Wodden	15
200	2000	4401020008221	Wodden	15
200	3000	4401020008421	Wodden	15



Silenta Premium Pipe with Double Socket

Dia. (mm)	Leng. (mm)	Code	Packing Type	Pc
58	1000	4401005802121	Wodden	96
78	1000	4401007806121	Wodden	60
110	1000	4401011006121	Wodden	36



Silenta Premium Elbow 15°

Dia. (mm)	Code	Packing Type	Pc
58	4501105830021	Base Box	40
78	4501107830021	Base Box	24
90	4501109030021	Base Box	39
110	4501111030021	Base Box	20
135	4501113530021	Base Box	12
160	4501116030021	Base Box	8



Silenta Premium Elbow 30°

Dia. (mm)	Code	Packing Type	Pc
58	4501105830121	Base Box	40
78	4501107830121	Base Box	24
90	4501109030121	Base Box	39
110	4501111030121	Base Box	20
135	4501113530121	Base Box	12
160	4501116030121	Base Box	8



Silenta Premium Elbow 45°

Dia. (mm)	Code	Packing Type	Pc
58	4501105830221	Base Box	40
78	4501107830221	Base Box	24
90	4501109030221	Base Box	32
110	4501111030221	Base Box	20
135	4501113530221	Base Box	12
160	4501116030221	Base Box	8
200	4501120030021	Base Box	4



Silenta Premium Pipe without Socket

Dia. (mm)	Leng. (mm)	Code	Packing Type	Pc
58	3000	4401005810021	Wodden	114
58	3000	4401007810021	Wodden	70
78	3000	4401009010021	Wodden	60
78	3000	4401011010021	Wodden	40
90	3000	4401013510021	Wodden	24
110	3000	4401016010021	Wodden	21
200	3000	4401020010021	Wodden	15



Silenta Premium Elbow 67,5°

Dia. (mm)	Code	Packing Type	Pc
58	4501105830421	Base Box	32
78	4501107830321	Base Box	40
90	4501109030421	Base Box	32
110	4501111030321	Base Box	16

Silenta Premium



Silenta Premium Elbow 87,5°

Dia. (mm)	Code	Packing	
		Type	Pc
58	4501105830321	Base Box	32
78	4501107830421	Base Box	40
90	4501109030321	Base Box	32
110	4501111030421	Base Box	16
135	4501113530321	Base Box	12
160	4501116030321	Base Box	8
200	4501120030121	Base Box	3



Silenta Premium Long Elbow 45°

Dia. (mm)	Code	Packing	
		Type	Pc
110	4501111030521	Base Box	8

Silenta Premium C.R. Double Branch

Dia. (mm)	Code	Packing	
		Type	Pc
90-90	4501209030721	Base Box	12



Silenta Premium Branch 45°

Dia. (mm)	Code	Packing	
		Type	Pc
58-58	4501205830021	Base Box	18
78-58	4501207830021	Base Box	12
78-78	4501207830121	Base Box	10
90-58	4501209030021	Base Box	8
90-90	4501209030121	Base Box	14
110-58	4501211030021	Base Box	14
110-78	4501211030121	Base Box	14
110-110	4501211030221	Base Box	10
135-78	4501213530021	Base Box	10
135-110	4501213530121	Base Box	6
135-135	4501213530221	Base Box	2
160-110	4501216030021	Base Box	5
160-135	4501216030121	Base Box	3
160-160	4501216030221	Base Box	3
200-110	4501220030021	Base Box	2
200-135	4501220030121	Base Box	2
200-160	4501220030221	Base Box	1
200-200	4501220030321	Base Box	1



Silenta Premium Branch 67,5°

Dia. (mm)	Code	Packing	
		Type	Pc
58-58	4501205830121	Base Box	18
78-58	4501207830221	Base Box	12
78-78	4501207830321	Base Box	20
110-58	4501211030321	Base Box	6
110-78	4501211030421	Base Box	5
110-110	4501211030521	Base Box	5



Silenta Premium Branch 87,5°

Dia. (mm)	Code	Packing	
		Type	Pc
58-58	4501205830221	Base Box	20
78-58	4501207830421	Base Box	32
78-78	4501207830521	Base Box	12
90-58	4501209030221	Base Box	18
90-78	4501209030321	Base Box	15
90-90	4501209030421	Base Box	12
110-58	4501211030621	Base Box	18
110-78	4501211030721	Base Box	15
110-110	4501211030821	Base Box	12
135-110	4501213530321	Base Box	4
135-135	4501213530421	Base Box	3
160-110	4501216031021	Base Box	5
160-160	4501216031121	Base Box	2



Silenta Premium Double Branch 45°

Dia. (mm)	Code	Packing	
		Type	Pc
110-110	4501211031021	Base Box	6
135-110	4501213531021	Base Box	2
160-110	4501216030521	Base Box	3



Silenta Premium Double Branch 4 out 87,5°

Dia. (mm)	Code	Packing	
		Type	Pc
110-110	4501211014121	Base Box	2



Silenta Premium Branch 5 out 87,5°

Dia. (mm)	Code	Packing	
		Type	Pc
110-110	4501211013121	Base Box	2



Silenta Premium Corner Double Branch 87,5°

Dia. (mm)	Code	Packing	
		Type	Pc
110-110	4501211031521	Base Box	8

Silenta Premium



Silenta Premium Socket with Central Register

Dia. (mm)	Code	Packing	
		Type	Pc
58	4501505830021	Base Box	52
78	4501507830021	Base Box	30
90	4501509030021	Base Box	18
110	4501511030021	Base Box	36
135	4501513530021	Base Box	10
160	4501516030021	Base Box	12
200	4501520030021	Base Box	3



Silenta Premium Adaptor

Dia. (mm)	Code	Packing	
		Type	Pc
58-50	4501905830121	Base Box	60
78-75	4501907830121	Base Box	36
135-125	4501913530121	Base Box	10



Silenta Premium Blind Cap

Dia. (mm)	Code	Packing	
		Type	Pc
58	4501905830021	Base Box	100
78	4501907830021	Base Box	50
90	4501909030021	Base Box	50
110	4501911030021	Base Box	36
135	4501913530021	Base Box	20
160	4501916030021	Base Box	12



Silenta Premium Sliding Reducer

Dia. (mm)	Code	Packing	
		Type	Pc
58-50	4501405830321	Base Box	84
78-58	4501407830421	Base Box	52
90-58	4501409030221	Base Box	60
90-78	4501409030321	Base Box	48
110-58	4501411030521	Base Box	30
110-78	4501411030421	Base Box	30
110-90	4501411030321	Base Box	24



Silenta Premium Reducer

Dia. (mm)	Code	Packing	
		Type	Pc
58-40	4501405830021	Base Box	60
58-50	4501405830121	Base Box	60
78-58	4501407830021	Base Box	40
78-75	4501407830121	Base Box	30
90-58	4501409030021	Base Box	32
90-78	4501409030121	Base Box	32
110-58	4501411030021	Base Box	24
110-78	4501411030121	Base Box	24
110-90	4501411030221	Base Box	18
135-110	4501413530021	Base Box	10
160-110	4501416030021	Base Box	8
160-135	4501416030121	Base Box	6
200-160	4501420030021	Base Box	4



Silenta Premium Repair Pipe (Long Socket)

Dia. (mm)	Code	Packing	
		Type	Pc
110	4501911030621	Base Box	20



Silenta Premium Clean Out (Circular)

Dia. (mm)	Code	Packing	
		Type	Pc
90	4501309030021	Base Box	8



Silenta Premium Parallel Branch

Dia. (mm)	Code	Packing	
		Type	Pc
110-110	4501211032021	Base Box	4



Silenta Premium Clean Out (Rectangular)

Dia. (mm)	Code	Packing	
		Type	Pc
110	4501311030021	Base Box	10
135	4501313530021	Base Box	6
160	4501316030021	Base Box	2

Silenta Premium



Silenta Premium Siphon Branch 90°

Dia. (mm)	Code	Packing Type	Pc
58-40	4501105830821	Base Box	48



Silenta Premium Double Branch with Radius 87,5°

Dia. (mm)	Code	Packing Type	Pc
90-90	4501109007021	Base Box	8
110-110	4501111031221	Base Box	4



Silenta Premium Radius Branch 87,5°

Dia. (mm)	Code	Packing Type	Pc
110-90	4501211031321	Base Box	8
110-110	4501211031221	Base Box	8



Silenta Premium Floor Trap

Dia. (mm)	Code	Packing Type	Pc
58-110	4501911031121	Base Box	4

What is Sound Insulation Performance?

Sound insulation performance is the sound insulation capability of the system against the vibrations that occur between the pipes used in the waste water installation and the fluids transmitted through these pipes. With Silenta Premium, Silenta 3A and Silenta FR Piping Systems, GF Hakan Plastik offers ultimate solutions against the sounds created in the installations.

Sources of sounds in the buildings can be listed as follows:

- Flushing
- Clogging of the flowing direction
- High water speeds
- Joints
- Discharge
- Wrong planning
- Faulty design

Due to critical drainage conditions, local vibrations occur in the piping system passages. They could have adverse impacts on sound characteristics.

To minimize and eliminate these impacts, Silenta Product Ranges reduce noise in the sound-critical areas with elbows having nominal widths of DN 58-DN 200, and ensures better noise reduction in the affected areas.

Why is Sound Protection Necessary?

Sound protection measures in a building aims to minimize the noise pollution in the rooms. Residents need to be protected against the noises emitted through air or caused by the building.

Unpleasant noises within the building as caused directly (created by the building) or indirectly (for example due to the construction engineering systems) can be easily resolved with the use of Silenta Product Range.

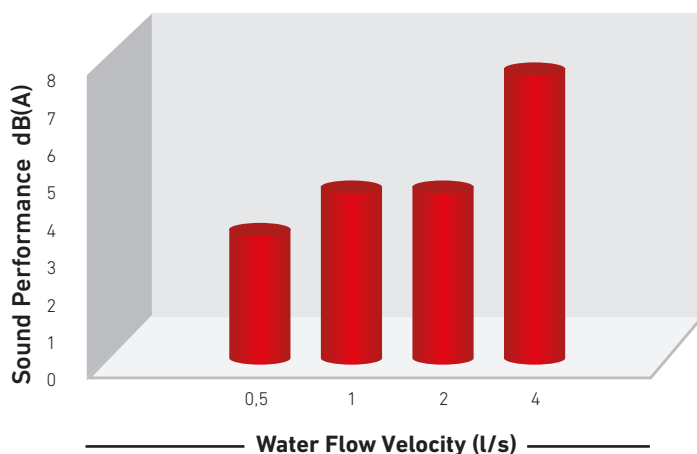
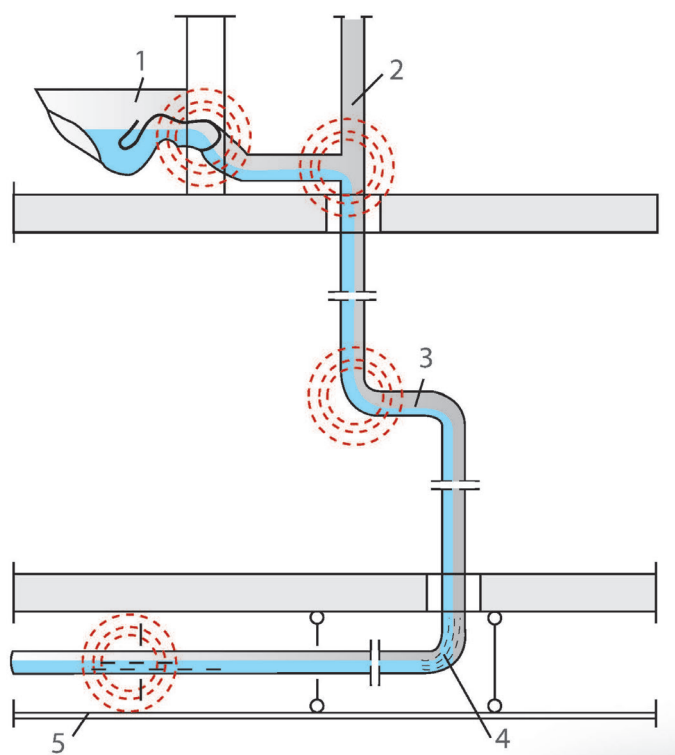

The above graphics indicate the results of the acoustic tests conducted by Fraunhofer Building Physics Institute.

Silenta Premium 13 dB(A) at 4 l/s flow

Silenta 3A 16 dB(A) at 4 l/s flow

Silenta FR 12 dB(A) at 4 l/s flow

Building Technology (BT) Solid and Waste Water Pipe Range Installation Instructions

- Silenta Premium Sound-Insulated Pipe Systems

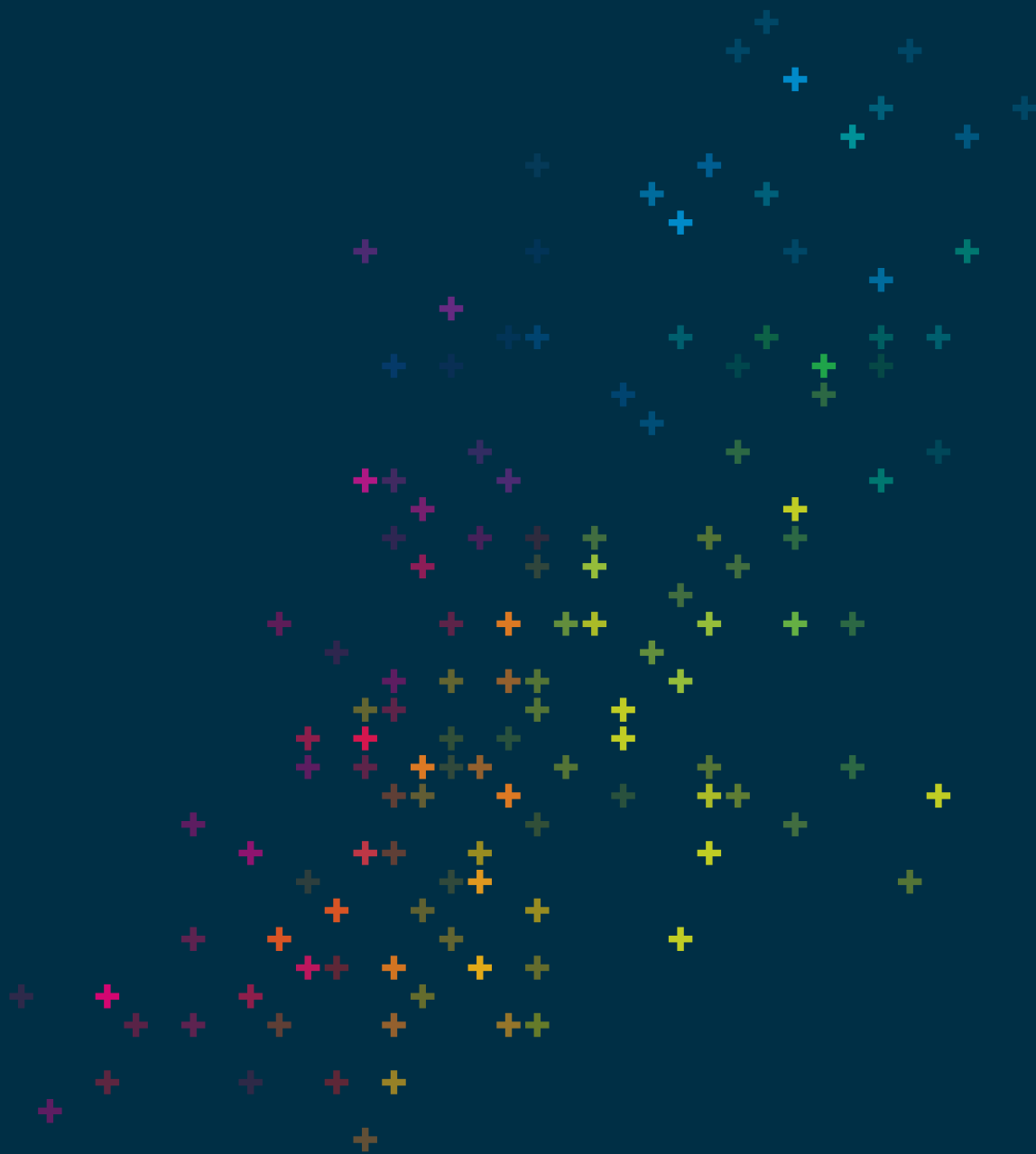

Installation

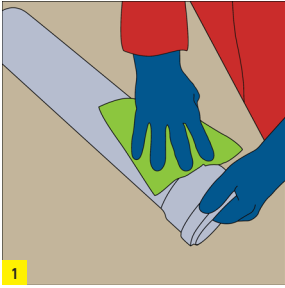

Make sure that your products are clean. If necessary, wipe the jointing points with a dry cloth.

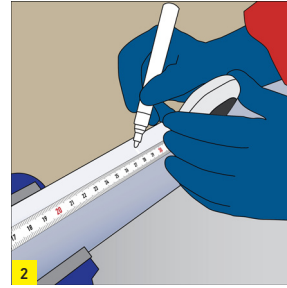

When interval measurements are required, mark the pipe with the desired measurements.

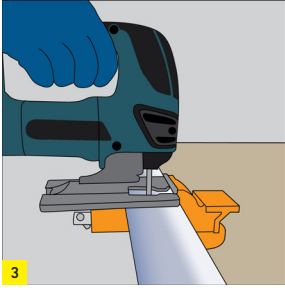

Cut in 90° angle by using a coping saw or a proper cutter.

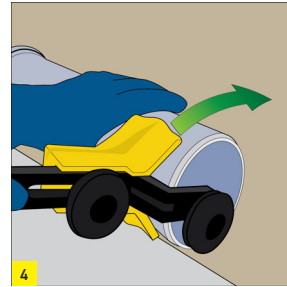

Chamfer the spigot of pipe by using a chamfering device or thick riffer.

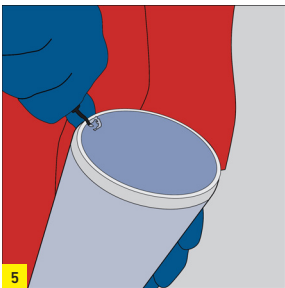

Remove the burrs on the external edges with a knife or scraper.

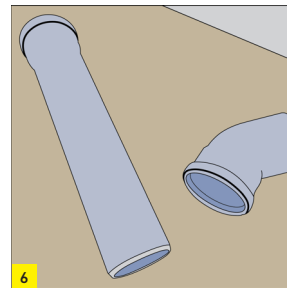

Now, your pipe is ready for installation.

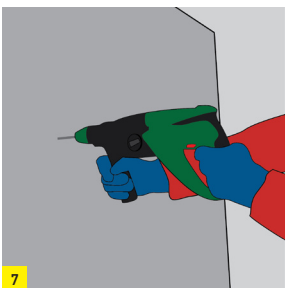

Drill the marked points with a driller and place dowels into the holes.

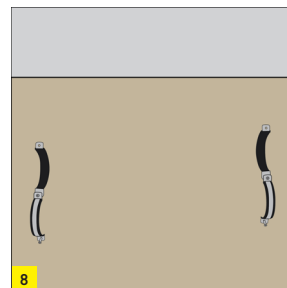

Mark the pipe clamp distances properly with 1% inclination on the wall or ceiling where they will be installed. (as flat wall)

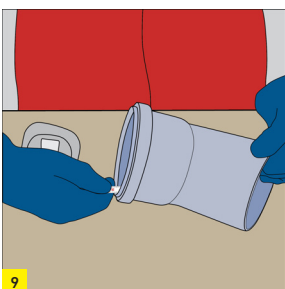

Mark the part of the pipe that will be attached to the fitting as much as the jointing distance.



Apply a lubricating liquid (silicone etc.) to the socket part of the pipe.

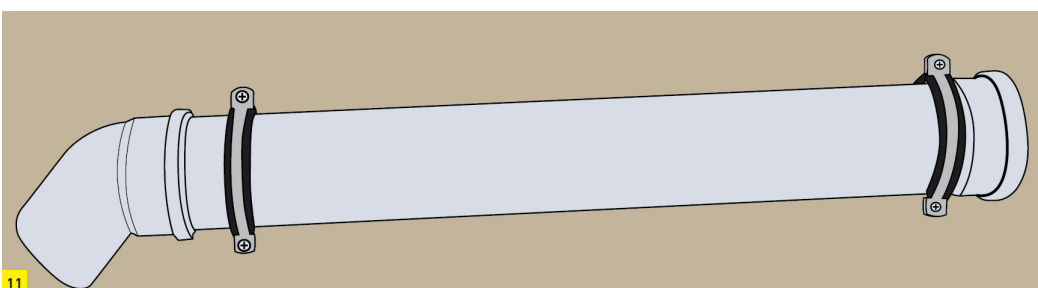

After the pipe and fittings are jointed, place them and tighten the clamps.

Installation

Rubber Ring (Push Fit) Jointing

- 1- Mouth of the pipe should be absolutely chamfered. If the mouth of the pipe was cut, it should be chamfered.
- 2- Check if the sealing gasket is accurately placed on the pipe or fitting socket groove.
- 3- All installation parts should be dry and clean. There should be no deformation, notches or similar scratches on the pipes or fittings.
- 4- Apply a proper silicone-based lubricating liquid on the spigot end of the pipe or fitting. Do not use liquid soap, grease or similar petroleum derivatives.

- 5- Parts to be jointed should be levelled.
- 6- Push the spigot end of the pipe or fitting into the socket completely. If the application is longer than 2 m, pull the spigot end 10 mm back after placing it into the socket completely, to prevent the effects of thermal expansion.
- 7- Finally, check again if the gap left for thermal expansion still exists or not.

Pipe Hanging and Clamping

Always use GF Hakan silent pipe clamp to minimize the sound caused by vibration. Maximum clamping distances of the pipes should always comply with the values provided in the following table.

- 1- While fixing the pipe with clamps, pay special attention to not cause any tension and stress on pipes.
- 2- Pipe cannot move after tightening the screws of the fixed clamps. For sliding clamps, pipe will continue to move inside the clamp even after tightening the screws.
- 3- For each line longer than 2 m, use 1 fixed clamp immediately after the muff part.
- 4- In vertical lines, always place the fixed clamp on the top point of the pipe and below the socket part.

- 5- While fitting the fixed clamp, pay attention to keep 10 mm distance left on the flat end for expansion.
- 6- Use a fixed clamp after each fitting or fitting group.
- 7- All clamps to be added to the system apart from the fixed clamps in the horizontal or vertical line should be sliding clamp that allows for thermal expansion caused by temperature changes.
- 8- Pipes and fittings should be fixed in short distances so that they do not slide and release.

Maximum distances between the clamps

Nominal External Diameter DN [mm]	Clamp Distance	
	For Horizontal Pipe Directions* Dmax m (max. 15 x da)	For Vertical Pipe Directions* Dmax. m
50	0,75	1,50
75	1,10	2,00
90	1,35	2,00
110	1,65	2,00
125	1,85	2,00
160	2,40	2,00
200	3,00	2,00
250	3,00	2,00

Installation

Silent Pipe Clamp

Silent waste water piping systems are tested by the German Fraunhofer Building Physics Institute in accordance with EN 14366 standard, and the reports about sound level are issued by this institute.

In the test equipment used in this institute, sound levels are measured at different flows and different parts of the building.

In the vertical lines, one group double and one single clamp should be used on each floor. In the horizontal lines, it is more suitable to use single clamp.

The test equipment in the institute laboratory is standard and the tests related to all waste water systems are conducted here. As seen in the test equipment below, pipe, fittings, installation wall thickness, water discharge amount as well as silent pipe clamp systems are also significant factors in the test report.



Clamp Details

The clamp on top, which is one of the double clamps used in the vertical lines, is fully tightened and grasps the pipe. The lower clamp is tightened up to the plastic wedges on the clamp. It is ensured that the rubber surfaces of the clamp are not jointed. In this system, the purpose is to absorb the vibration transmitted from waste water to pipe inside the first clamp and to minimize the vibration on the wall through the second clamp.

The single clamp in the vertical lines is tightened up to the plastic wedges on the clamp and it is ensured that the pipe is fixed to the wall. The single clamp in the horizontal lines is tightened up to the plastic wedges on the clamp and it is ensured that the pipe is fixed to the ceiling or wall.

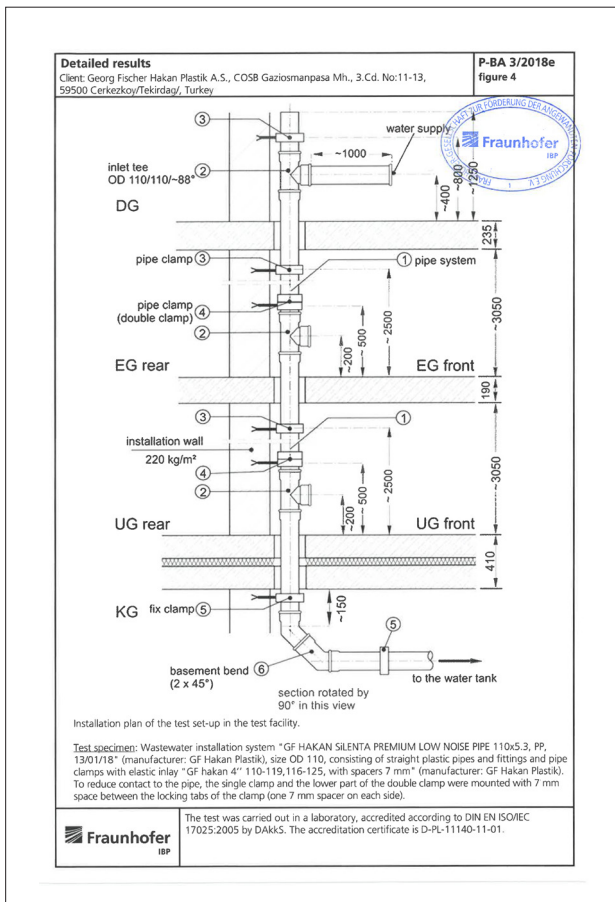

To achieve maximum acoustic performance, the silent pipe clamps used in the test should be used in the installations as well.

Although there are different types of silent pipe clamps, they are available in two kinds as fixed and movable.

The noise created in the waste water systems is transmitted by two methods as air born and structure born.

1- Sound waves transmitted through air cause pressure in the ambient and result in vibration on the objects and surfaces that they hit. Thanks to the special formulas used in GF Hakan Plastik Silenta products, these vibrations are absorbed and prevented from being transferred out of pipe.

2- Sound waves transmitted through contact occur as a result of the waste water and waste hitting the pipe wall. These vibrations are transferred on the wall of the installation through contact. The sound created by contact is significantly absorbed by the special molecular structure of Silenta and specially-designed GF Hakan silent clamps.

Installation

GF Hakan silent waste water pipe clamps ensure EN 14366 silence norms. In the waste water systems within buildings, correct clamps, their positions and distances are as important as silent pipes and fittings.

The clamp on top, which is one of the double clamps used in the vertical lines, is fully tightened and grasps the pipe. The lower clamp is tightened up to the plastic wedges on the clamp. It is ensured that the rubber surfaces of the clamp are not jointed. In this system, the purpose is to absorb the vibration transmitted from waste water to pipe inside the first clamp and to minimize the vibration on the wall through the second clamp.

The single clamp in the horizontal lines is tightened up to the plastic wedges on the clamp and it is ensured that the pipe is fixed to the ceiling or wall.

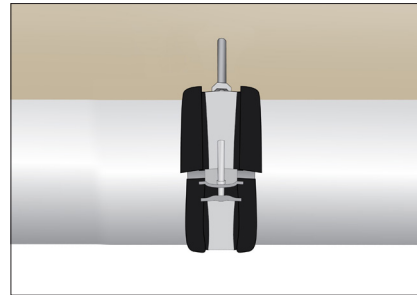
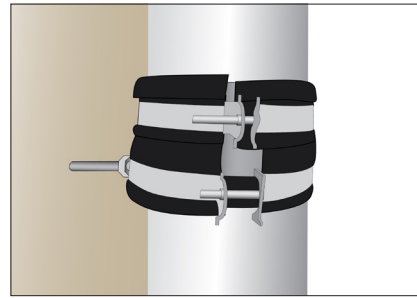

Packaging, Storage and Transportation

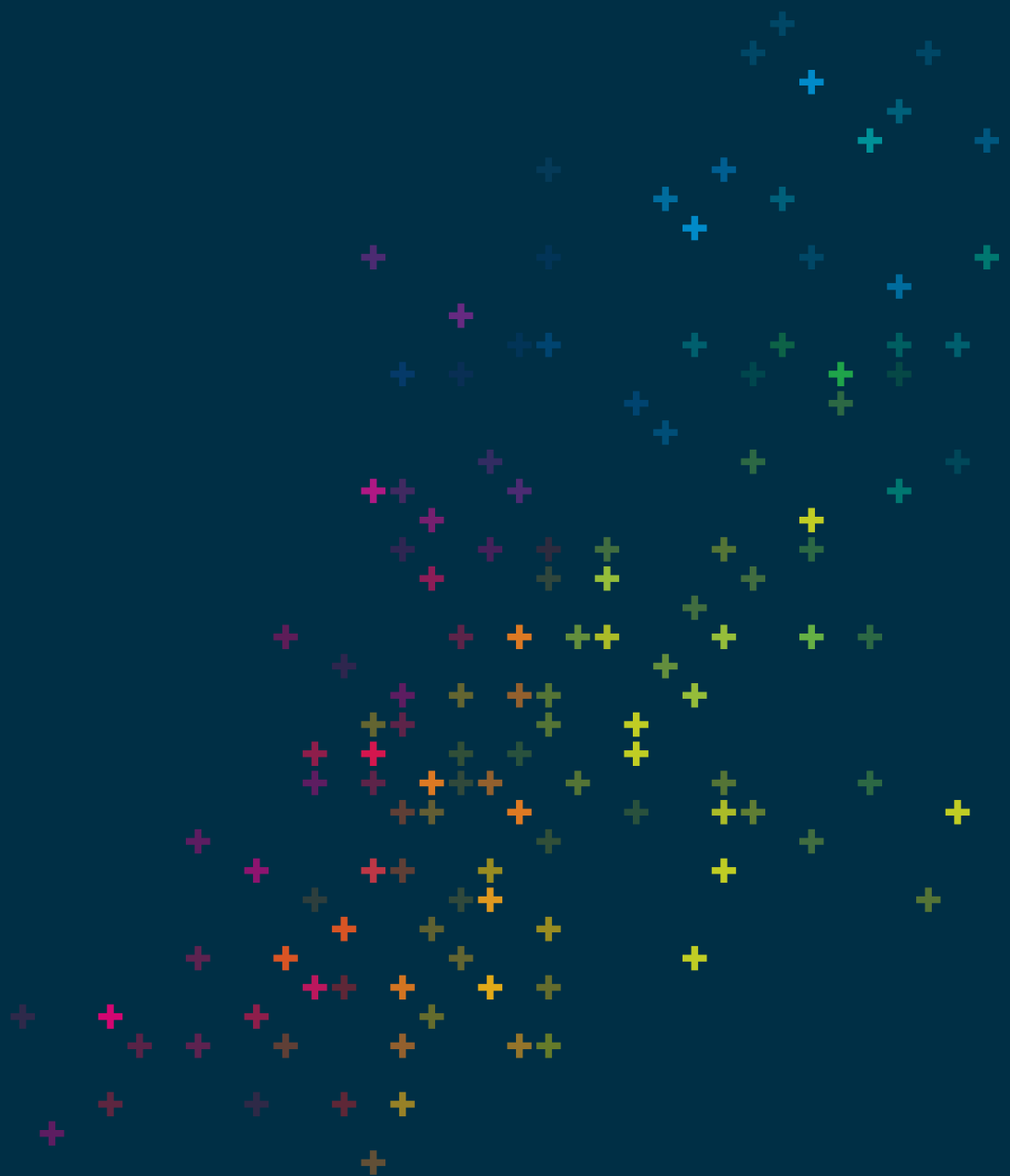

Packaging

GF Hakan Plastik pipes and fittings are packed as ready for transport in a customer-friendly way. Packing ensures safety, efficient storage and easy transport.

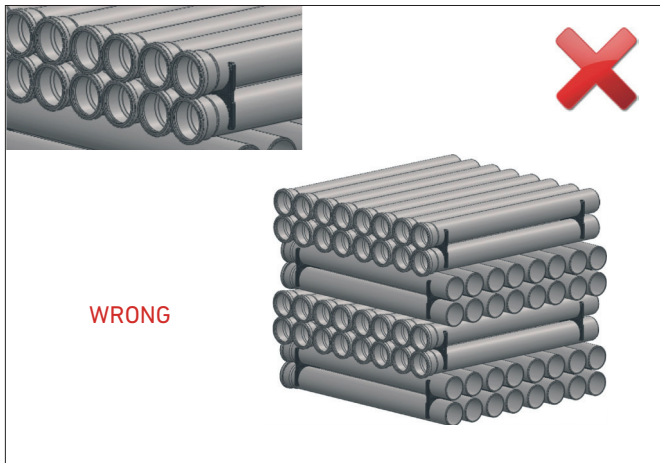
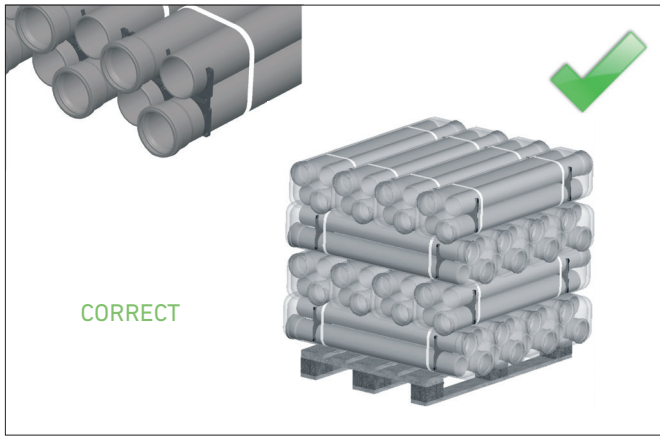



Pipes and fittings with socket are placed in a way that they will not stay on top of each other.



Pipes are packed by plastic clamps to hold them together. Stretch film is applied to protect pipes from pipes dust and stains.

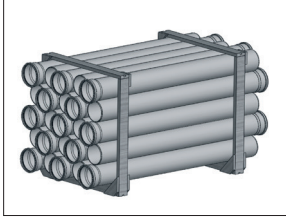

Waste water pipes are shipped on wooden frames or pallets according to the demands of customers.



Short parts with the length of 150, 250 and 500 mm are packed in carton boxes like connection parts.

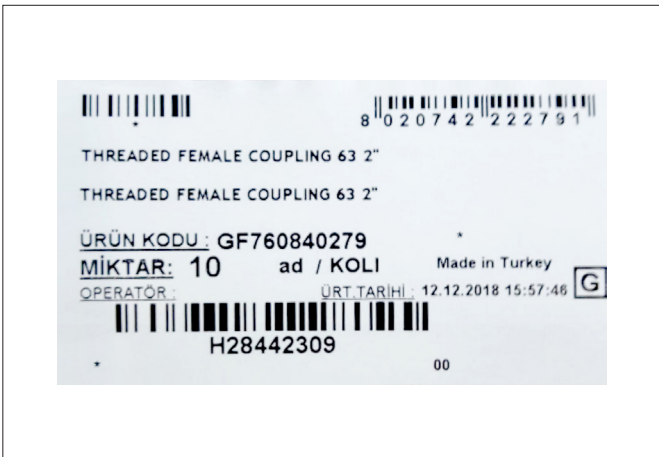

All product ranges are identified in the Warehouse Management System (WMS) by barcode label. Barcode system ensures management of products and prevents complexity and errors during storage and loading.

Storage

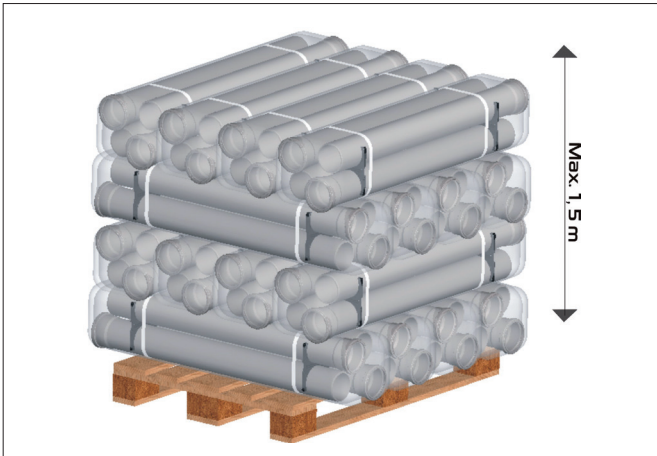

Method of storage should not cause any outflow and should not damage the pipes. As long as they are stored properly, no permanent deformations or damages will occur on the pipes and fittings. Pipes should not be stacked above 1,5 m. Pipes should be safe against sliding.

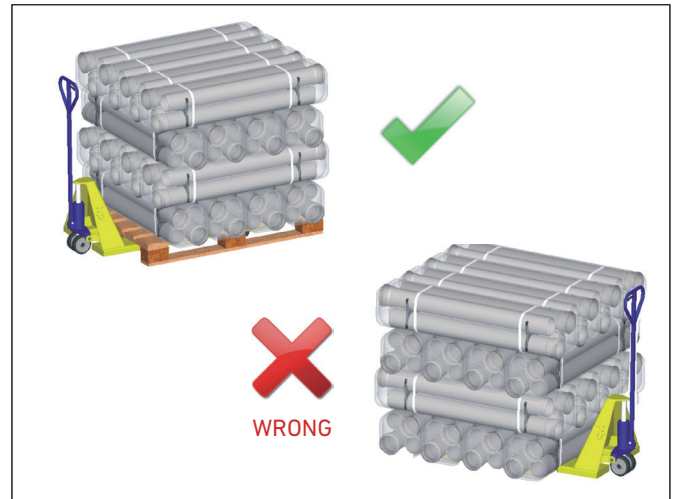

Pipes and fittings packed in carton boxes should be protected against moisture. Carton boxes should be sealed and stored in a dry area.

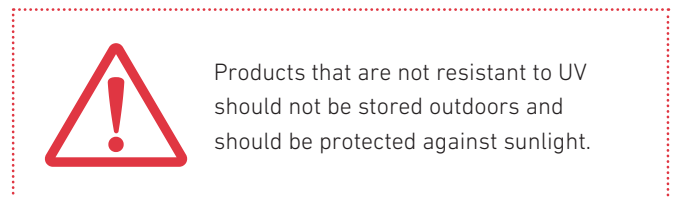

Transportation

Pipes should be carefully transported to prevent any damages. Avoid sudden and hard pressures on pipes and fittings that might cause freezing in cold weather conditions. Ensure that pipes are not slid and dropped on the floor. Loading and unloading and packing of pipes in a block should be carried out by means of forklifts having flat threads and extensions.

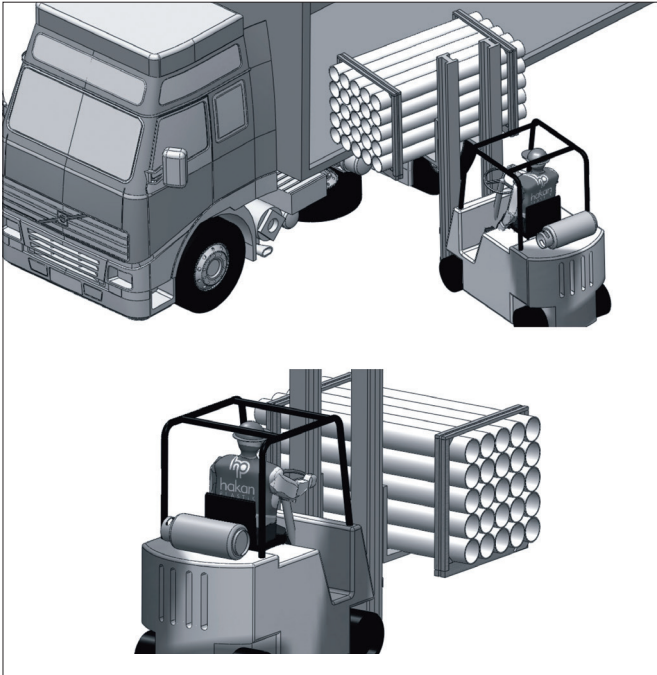

Technical Tables

- Chemical Resistance Tables

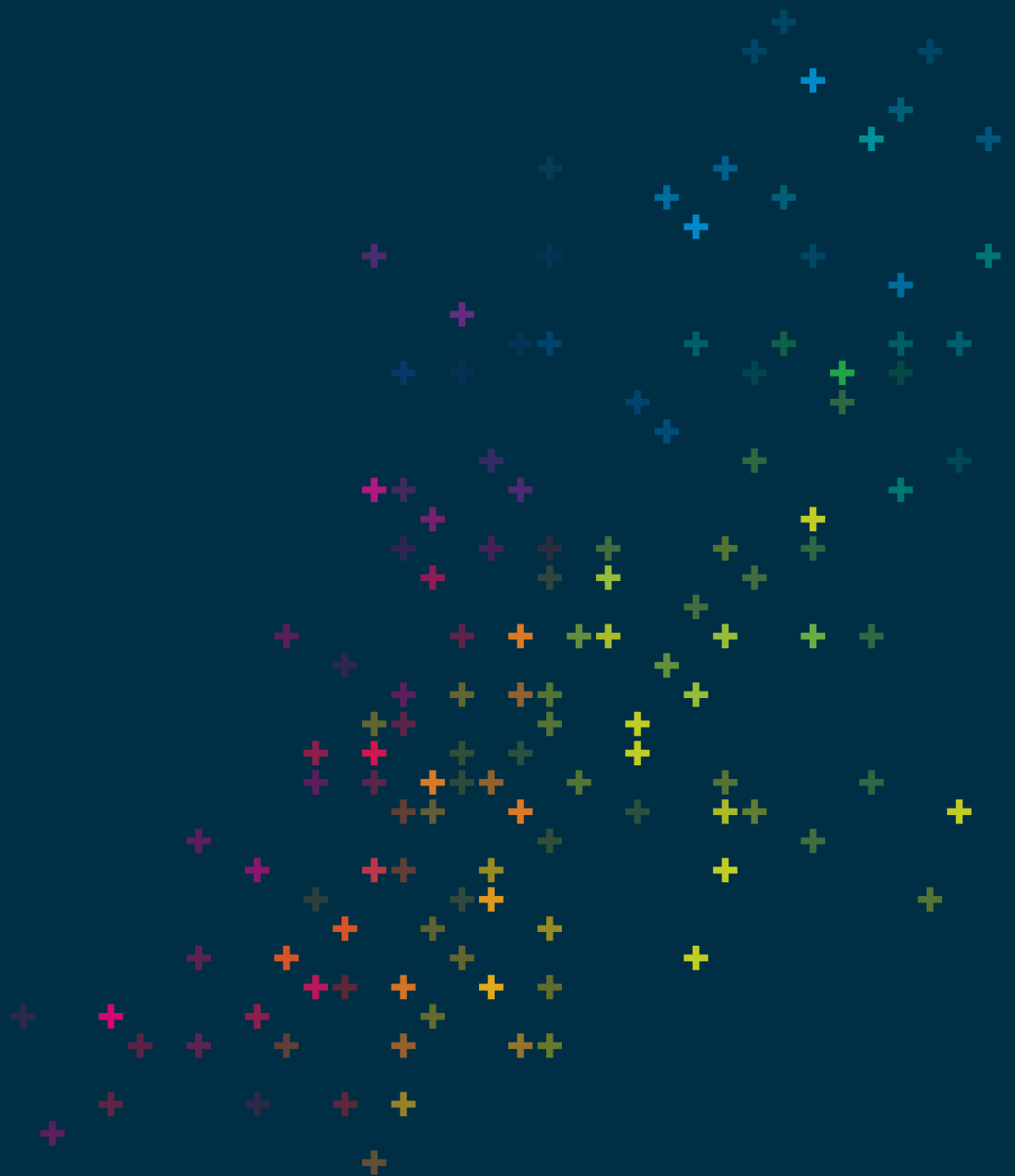

Chemical Resistance Tables

++ Resistant
 + Limited Resistance
 0 Contact GF Hakan Plastik
 - Not Resistant

2-Chloroethanol	Fluid Temperatures			
	20 °C	40 °C	60 °C	80 °C
PVC-U	-			
PE	++	+	0	
PP	++	+	0	-
Acetaldehyde	Fluid Temperatures			
	20 °C	40 °C	60 °C	80 °C
PVC-U	-			
PE	++	0	-	
PP	0	-		
Acetaldehyde, 0-40% aqueous solution	Fluid Temperatures			
	20 °C	40 °C	60 °C	80 °C
PVC-U	-			
PE	++	0	-	
PP	++	0	0	-
Acetic acid, > 80 % aqueous solution	Fluid Temperatures			
	20 °C	40 °C	60 °C	80 °C
PVC-U	0	0	-	
PE	+	0	-	
PP	0	0	-	
Acetic acid, >10-50 % aqueous solution	Fluid Temperatures			
	20 °C	40 °C	60 °C	80 °C
PVC-U	+	+	+	-
PE	+	+	0	-
PP	+	+	0	0
Acetic acid, >50-60 % aqueous solution	Fluid Temperatures			
	20 °C	40 °C	60 °C	80 °C
PVC-U	+	0	0	-
PE	+	+	0	-
PP	+	+	0	0
Acetic acid, >60-80 % aqueous solution	Fluid Temperatures			
	20 °C	40 °C	60 °C	80 °C
PVC-U	+	0	0	-
PE	+	+	0	-
PP	+	+	0	0
Acetic acid, 0-10 % aqueous solution	Fluid Temperatures			
	20 °C	40 °C	60 °C	80 °C
PVC-U	+	+	+	-
PE	+	+	0	-
PP	+	+	0	0
Acetic acid anhydride	Fluid Temperatures			
	20 °C	40 °C	60 °C	80 °C
PVC-U	-			
PE	++	0	-	
PP	++	0	-	
Acetone	Fluid Temperatures			
	20 °C	40 °C	60 °C	80 °C
PVC-U	-			
PE	++	++	0	-
PP	++	++	++	0
Acetone, up to 10 % aqueous solution	Fluid Temperatures			
	20 °C	40 °C	60 °C	80 °C
PVC-U	-			
PE	++	++	++	-
PP	++	++	++	0
Acetonitrile	Fluid Temperatures			
	20 °C	40 °C	60 °C	80 °C
PVC-U	-			
PE	0	-		
PP	0	-		
Acetophenone	Fluid Temperatures			
	20 °C	40 °C	60 °C	80 °C
PVC-U	-			
PE	0	-		
PP	0	-		
Acrylic acid ethylester	Fluid Temperatures			
	20 °C	40 °C	60 °C	80 °C
PVC-U	-			

PE	0	-		
PP	-			
Acrylic acid methylester	Fluid Temperatures			
	20 °C	40 °C	60 °C	80 °C
PVC-U	-			
PE	0	-		
PP	0	-		
Acrylonitrile	Fluid Temperatures			
	20 °C	40 °C	60 °C	80 °C
PVC-U	-			
PE	++	++	++	-
PP	++	0	0	-
Adipic acid, aqueous, saturated solution	Fluid Temperatures			
	20 °C	40 °C	60 °C	80 °C
PVC-U	++	++	-	
PE	++	++	++	-
PP	++	++	++	++
Allyl alcohol, 96% solution	Fluid Temperatures			
	20 °C	40 °C	60 °C	80 °C
PVC-U	0	-		
PE	++	++	0	-
PP	0	0	-	
Aluminium salts, aqueous, saturated solutions	Fluid Temperatures			
	20 °C	40 °C	60 °C	80 °C
PVC-U	++	++	++	-
PE	++	++	++	-
PP	++	++	++	++
Ammonia, gaseous, dry / wet	Fluid Temperatures			
	20 °C	40 °C	60 °C	80 °C
PVC-U	++	++	++	-
PE	++	++	++	-
PP	++	++	++	0
Ammonium Acetate, aqueous solutions	Fluid Temperatures			
	20 °C	40 °C	60 °C	80 °C
PVC-U	++	++	++	-
PE	++	++	++	-
PP	++	++	++	++
Ammonium hydroxide, aqueous	Fluid Temperatures			
	20 °C	40 °C	60 °C	80 °C
PVC-U	++	++	++	-
PE	++	++	++	-
PP	++	++	++	0
Ammonium salts, various concentrations, aqueous solutions	Fluid Temperatures			
	20 °C	40 °C	60 °C	80 °C
PVC-U	++	++	++	-
PE	++	++	++	-
PP	++	++	++	++
Amyl acetate	Fluid Temperatures			
	20 °C	40 °C	60 °C	80 °C
PVC-U	-			
PE	++	0	-	
PP	0	-		
Amyl alcohol	Fluid Temperatures			
	20 °C	40 °C	60 °C	80 °C
PVC-U	++	++	0	-
PE	++	++	++	-
PP	++	++	++	0
Aniline	Fluid Temperatures			
	20 °C	40 °C	60 °C	80 °C
PVC-U	-			
PE	++	0	0	-
PP	++	++	0	-
Antimony trichloride, 0-80 % aqueous solutions	Fluid Temperatures			
	20 °C	40 °C	60 °C	80 °C
PVC-U	++	++	0	-
PE	++	++	++	-
PP	++	++	++	0

Chemical Resistance

	Fluid Temperatures			
	20 °C	40 °C	60 °C	80 °C
Aqua regia				
PVC-U	0	-		
PE	-			
PP	-			
Arsenic acid, 80% aqueous solutions				
PVC-U	++	++	0	-
PE	++	++	++	-
PP	++	++	++	++
Barium salts, aqueous, saturated solutions				
PVC-U	++	++	++	-
PE	++	++	++	-
PP	++	++	++	++
Beer				
PVC-U	++	++	++	-
PE	++	++	++	-
PP	++	++	++	++
Benzaldehyde				
PVC-U	-			
PE	++	0	-	
PP	++	0	-	
Benzene				
PVC-U	-			
PE	-			
PP	-			
Benzene sulfonic acid				
PVC-U	++	++	0	-
PE	++	++	0	-
PP	++	++	0	-
Benzoic acid, aqueous solutions				
PVC-U	++	++	0	-
PE	++	++	++	-
PP	++	++	++	++
Benzyl alcohol				
PVC-U	0	-		
PE	++	++	0	-
PP	++	++	0	-
Beryllium salts, aqueous solutions				
PVC-U	++	++	++	-
PE	++	++	++	-
PP	++	++	++	++
Boric acid, aqueous solutions				
PVC-U	++	++	0	-
PE	++	++	++	-
PP	++	++	++	++
Brine				
PVC-U	++	++	++	-
PE	++	++	++	-
PP	++	++	++	++
Bromine water, aqueous solution				
PVC-U	0	0	-	
PE	-			
PP	-			
Bromine, pure, liquid or gaseous, dry and wet				
PVC-U	-			

PE	-			
PP	-			
Butadiene, gaseous				
PVC-U	++	0	-	
PE	0	-		
PP	0	-		
Butane, gaseous				
PVC-U	++	++	0	-
PE	++	++	0	-
PP	++	++	0	-
Butanediol-1,4,				
PVC-U	0	-		
PE	++	++	++	-
PP	++	++	++	0
Butanediol-1,4, technically pure				
PVC-U	++	++	0	
PE	++	++	0	
PP	++	++	0	
Butanol				
PVC-U	++	++	0	-
PE	++	++	0	-
PP	++	++	0	-
Butyl acetate				
PVC-U	-			
PE	+	0	-	
PP	0	-		
Butyl phenol, p-tertiary				
PVC-U	0	-		
PE	0	-		
PP	0	-		
Cadmium salts, aqueous solutions				
PVC-U	++	++	++	-
PE	++	++	++	-
PP	++	++	++	0
Caesium salts, aqueous solutions				
PVC-U	++	++	++	-
PE	++	++	++	-
PP	++	++	++	++
Calcium hydroxide, aqueous solution				
PVC-U	++	++	++	-
PE	++	++	++	-
PP	++	++	++	++
Calcium salts, aqueous solutions				
PVC-U	++	++	++	-
PE	++	++	++	-
PP	++	++	++	++
Carbon dioxide, gaseous, anhydrous				
PVC-U	++	++	++	-
PE	++	++	++	-
PP	++	++	++	++
Carbon tetrachloride				
PVC-U	-			
PE	-			
PP	-			

Chemical Resistance

Carbonic acid, CO2 in H2O	Fluid Temperatures			
	20 °C	40 °C	60 °C	80 °C
PVC-U	++	++	0	-
PE	++	++	++	-
PP	++	++	++	++
Chloric acid, >10-20% aqueous solution	Fluid Temperatures			
	20 °C	40 °C	60 °C	80 °C
PVC-U	++	0	-	
PE	0	-		
PP	0	-		
Chloric acid, 0-10 % aqueous solution	Fluid Temperatures			
	20 °C	40 °C	60 °C	80 °C
PVC-U	++	0	-	
PE	0	-		
PP	0	-		
Chlorine, gaseous, dry, pure	Fluid Temperatures			
	20 °C	40 °C	60 °C	80 °C
PVC-U	0	0	-	
PE	-			
PP	-			
Chlorine, gaseous, wet	Fluid Temperatures			
	20 °C	40 °C	60 °C	80 °C
PVC-U	0	0	-	
PE	-			
PP	-			
Chlorine water, <= 2 ppm Chlorine	Fluid Temperatures			
	20 °C	40 °C	60 °C	80 °C
PVC-U	++	++	++	-
PE	++	++	0	-
PP	++	++	++	0
Chlorine water, saturated solution	Fluid Temperatures			
	20 °C	40 °C	60 °C	80 °C
PVC-U	++	++	0	-
PE	-			
PP	-			
Chloroacetic acid, 100 %	Fluid Temperatures			
	20 °C	40 °C	60 °C	80 °C
PVC-U	0	0	-	
PE	++	++	0	-
PP	++	++	0	-
Chloroacetic acid, 50 % aqueous solution	Fluid Temperatures			
	20 °C	40 °C	60 °C	80 °C
PVC-U	++	0	0	-
PE	++	++	0	-
PP	++	++	++	0
Chlorobenzene	Fluid Temperatures			
	20 °C	40 °C	60 °C	80 °C
PVC-U	-			
PE	0	-		
PP	0	-		
Chlorosulfonic acid	Fluid Temperatures			
	20 °C	40 °C	60 °C	80 °C
PVC-U	0	-		
PE	-			
PP	-			
Chromic acid, <10 % aqueous solution	Fluid Temperatures			
	20 °C	40 °C	60 °C	80 °C
PVC-U	+	+	-	
PE	-			
PP	-			
Chromic acid, > 30 % aqueous solution	Fluid Temperatures			
	20 °C	40 °C	60 °C	80 °C
PVC-U	0	-		
PE	-			
PP	-			

Chromic Acid, >=10-30 %, aqueous solutions	Fluid Temperatures			
	20 °C	40 °C	60 °C	80 °C
PVC-U	+	+	-	
PE	-			
PP	-			
Chromium (III) -salts, aqueous, saturated solutions	Fluid Temperatures			
	20 °C	40 °C	60 °C	80 °C
PVC-U	++	++	++	-
PE	++	++	0	-
PP	++	++	0	-
Citric acid, aqueous solutions	Fluid Temperatures			
	20 °C	40 °C	60 °C	80 °C
PVC-U	++	++	++	-
PE	++	++	++	-
PP	++	++	++	++
Compressed air, containing oil	Fluid Temperatures			
	20 °C	40 °C	60 °C	80 °C
PVC-U	-			
PE	0	0	0	-
PP	0	0	0	-
Copper I/II salts, aqueous solutions	Fluid Temperatures			
	20 °C	40 °C	60 °C	80 °C
PVC-U	++	++	++	-
PE	++	++	0	-
PP	++	++	++	0
Crotonaldehyde	Fluid Temperatures			
	20 °C	40 °C	60 °C	80 °C
PVC-U	-			
PE	++	0	0	-
PP	++	0	-	-
Cyclohexane	Fluid Temperatures			
	20 °C	40 °C	60 °C	80 °C
PVC-U	++	0	-	
PE	++	0	-	
PP	++	0	-	
Cyclohexanol	Fluid Temperatures			
	20 °C	40 °C	60 °C	80 °C
PVC-U	++	++	0	-
PE	++	++	0	-
PP	++	++	0	-
Cyclohexanone	Fluid Temperatures			
	20 °C	40 °C	60 °C	80 °C
PVC-U	-			
PE	++	0	-	
PP	0	0	-	
Dextrine, aqueous solutions	Fluid Temperatures			
	20 °C	40 °C	60 °C	80 °C
PVC-U	++	++	++	-
PE	++	++	++	-
PP	++	++	++	0
Dibrombenzene	Fluid Temperatures			
	20 °C	40 °C	60 °C	80 °C
PVC-U	-			
PE	-			
PP	-			
Dibutyl ether	Fluid Temperatures			
	20 °C	40 °C	60 °C	80 °C
PVC-U	-			
PE	0	0	-	
PP	0	0	-	
Dibutyl phthalate	Fluid Temperatures			
	20 °C	40 °C	60 °C	80 °C
PVC-U	++	++	0	-
PE	++	++	0	-
PP	++	0	-	
Dichloroacetic acid	Fluid Temperatures			
	20 °C	40 °C	60 °C	80 °C

Chemical Resistance

PVC-U	++	0	-	
PE	0	-		
PP	0	-		
Dichloroacetic acid, <= 50 % aqueous solution	Fluid Temperatures			
	20 °C	40 °C	60 °C	80 °C
PVC-U	++	++	0	-
PE	++	++	0	-
PP	++	++	0	-
Dichloroacetic acid methyl ester	Fluid Temperatures			
	20 °C	40 °C	60 °C	80 °C
PVC-U	-			
PE	++	++	0	-
PP	++	++	++	0
Dichlorobenzene	Fluid Temperatures			
	20 °C	40 °C	60 °C	80 °C
PVC-U	-			
PE	0	-		
PP	0	-		
Dichlorodifluoromethane, gaseous	Fluid Temperatures			
	20 °C	40 °C	60 °C	80 °C
PVC-U	-			
PE	0	-		
PP	0	-		
Dichloroethylene	Fluid Temperatures			
	20 °C	40 °C	60 °C	80 °C
PVC-U	-			
PE	-			
PP	-			
Diesel oil	Fluid Temperatures			
	20 °C	40 °C	60 °C	80 °C
PVC-U	0	0	-	
PE	0	0	-	
PP	0	-		
Diethanolamine, aqueous solution	Fluid Temperatures			
	20 °C	40 °C	60 °C	80 °C
PVC-U	-			
PE	++	0	-	
PP	++	0	-	
Diethyl ether	Fluid Temperatures			
	20 °C	40 °C	60 °C	80 °C
PVC-U	-			
PE	0	-		
PP	0	-		
Diethylamine	Fluid Temperatures			
	20 °C	40 °C	60 °C	80 °C
PVC-U	-			
PE	++	0	-	
PP	++	0	-	
Diisobutyl ketone	Fluid Temperatures			
	20 °C	40 °C	60 °C	80 °C
PVC-U	-			
PE	++	0	-	
PP	++	0	-	
Diisopropyl ether	Fluid Temperatures			
	20 °C	40 °C	60 °C	80 °C
PVC-U	-			
PE	0	-		
PP	0	-		
Dimethyl formamide	Fluid Temperatures			
	20 °C	40 °C	60 °C	80 °C
PVC-U	-			
PE	++	++	0	-
PP	++	++	++	0
Dimethylamine	Fluid Temperatures			
	20 °C	40 °C	60 °C	80 °C
PVC-U	-			
PE	++	0	-	
PP	++	0	-	

Dioxane	Fluid Temperatures			
	20 °C	40 °C	60 °C	80 °C
PVC-U	-			
PE	++	0	-	
PP	0	-		
Ethanol, <= 50% aqueous solution	Fluid Temperatures			
	20 °C	40 °C	60 °C	80 °C
PVC-U	++	++	0	-
PE	++	++	++	-
PP	++	++	++	++
Ethyl alcohol, 96%	Fluid Temperatures			
	20 °C	40 °C	60 °C	80 °C
PVC-U	++	++	0	-
PE	++	++	++	-
PP	++	++	++	++
Ethanolamine	Fluid Temperatures			
	20 °C	40 °C	60 °C	80 °C
PVC-U	-			
PE	++	0	-	
PP	++	0	-	
Ethyl benzene	Fluid Temperatures			
	20 °C	40 °C	60 °C	80 °C
PVC-U	-			
PE	0	-		
PP	0	-		
Ethylacetate	Fluid Temperatures			
	20 °C	40 °C	60 °C	80 °C
PVC-U	-			
PE	++	0		
PP	++	0		
Ethylchloride, gaseous	Fluid Temperatures			
	20 °C	40 °C	60 °C	80 °C
PVC-U	-			
PE	0	-		
PP	0	-		
Ethylene diamine	Fluid Temperatures			
	20 °C	40 °C	60 °C	80 °C
PVC-U	-			
PE	++	++	++	-
PP	++	++	++	0
Ethylene glycol	Fluid Temperatures			
	20 °C	40 °C	60 °C	80 °C
PVC-U	-			
PE	+	+	0	-
PP	+	+	0	-
Ethylene glycol, <= 50% aqueous solution	Fluid Temperatures			
	20 °C	40 °C	60 °C	80 °C
PVC-U	++	++	0	-
PE	+	+	0	-
PP	+	+	+	0
Ethylenediamine tetraacetic acid, aqueous solution	Fluid Temperatures			
	20 °C	40 °C	60 °C	80 °C
PVC-U	0	-		
PE	+	+	0	-
PP	+	+	0	-
Ferric chloride	Fluid Temperatures			
	20 °C	40 °C	60 °C	80 °C
PVC-U	++	++	++	-
PE	++	++	++	-
PP	++	++	++	++
Fluorosilicic acid, <= 32 % aqueous solutions	Fluid Temperatures			
	20 °C	40 °C	60 °C	80 °C
PVC-U	++	++	++	-
PE	++	++	++	-
PP	++	++	++	0

Chemical Resistance

Formaldehyde, <= 40 % aqueous solution	Fluid Temperatures			
	20 °C	40 °C	60 °C	80 °C
PVC-U	+	+	0	-
PE	+	+	0	-
PP	+	+	0	-
Formamide	Fluid Temperatures			
	20 °C	40 °C	60 °C	80 °C
PVC-U	-			
PE	++	++	++	-
PP	++	++	++	0
Formic acid, > 25-50 % aqueous solution	Fluid Temperatures			
	20 °C	40 °C	60 °C	80 °C
PVC-U	+	+	0	-
PE	+	+	0	-
PP	+	+	0	-
Formic acid, > 60 % aqueous solution	Fluid Temperatures			
	20 °C	40 °C	60 °C	80 °C
PVC-U	0	-		
PE	+	+	0	-
PP	0	-		
Formic acid, >10-25 % aqueous solution	Fluid Temperatures			
	20 °C	40 °C	60 °C	80 °C
PVC-U	+	+	0	-
PE	+	+	0	-
PP	+	+	0	-
Formic acid, >50-60 %, aqueous solution	Fluid Temperatures			
	20 °C	40 °C	60 °C	80 °C
PVC-U	+	+	0	-
PE	+	+	0	-
PP	+	+	0	-
Formic acid, 0-10% aqueous solution	Fluid Temperatures			
	20 °C	40 °C	60 °C	80 °C
PVC-U	+	+	0	-
PE	+	+	0	-
PP	++	+	0	-
Fuel oil, heavy fuel oil	Fluid Temperatures			
	20 °C	40 °C	60 °C	80 °C
PVC-U	-			
PE	0	-		
PP	0	-		
Furfural	Fluid Temperatures			
	20 °C	40 °C	60 °C	80 °C
PVC-U	-			
PE	++	++	0	-
PP	++	0	0	0
Furfuryl alcohol	Fluid Temperatures			
	20 °C	40 °C	60 °C	80 °C
PVC-U	-			
PE	++	++	0	-
PP	++	++	0	-
Gasoline	Fluid Temperatures			
	20 °C	40 °C	60 °C	80 °C
PVC-U	0	-		
PE	0	-		
PP	0	-		
Gelatine, aqueous solution	Fluid Temperatures			
	20 °C	40 °C	60 °C	80 °C
PVC-U	++	++	0	-
PE	++	++	++	-
PP	++	++	++	0
Glucose, aqueous solutions	Fluid Temperatures			
	20 °C	40 °C	60 °C	80 °C
PVC-U	++	++	0	-
PE	++	++	++	-
PP	++	++	++	++

Glycerol, Glycerin	Fluid Temperatures			
	20 °C	40 °C	60 °C	80 °C
PVC-U	++	++	++	-
PE	++	++	++	-
PP	++	++	++	++
Glycin, 10% aqueous solution	Fluid Temperatures			
	20 °C	40 °C	60 °C	80 °C
PVC-U	++	++	0	-
PE	++	++	0	-
PP	++	++	0	-
Glycolic acid, 37% aqueous solution	Fluid Temperatures			
	20 °C	40 °C	60 °C	80 °C
PVC-U	++	++	0	-
PE	+	+	0	-
PP	+	+	0	-
Heptane	Fluid Temperatures			
	20 °C	40 °C	60 °C	80 °C
PVC-U	++	0	-	
PE	++	0	-	
PP	0	-		
Hexane	Fluid Temperatures			
	20 °C	40 °C	60 °C	80 °C
PVC-U	++	0	-	
PE	++	0	-	
PP	0	-		
Hydrazine Hydrate, aqueous solution	Fluid Temperatures			
	20 °C	40 °C	60 °C	80 °C
PVC-U	++	0	-	
PE	++	++	0	-
PP	++	0	-	
Hydrochloric acid, <= 10% aqueous solution	Fluid Temperatures			
	20 °C	40 °C	60 °C	80 °C
PVC-U	++	++	++	-
PE	+	+	+	-
PP	+	+	+	+
Hydrochloric acid, > 10-25 % aqueous solution	Fluid Temperatures			
	20 °C	40 °C	60 °C	80 °C
PVC-U	++	++	++	-
PE	+	+	+	-
PP	+	+	+	+
Hydrochloric acid, > 25-30% aqueous solution	Fluid Temperatures			
	20 °C	40 °C	60 °C	80 °C
PVC-U	++	++	++	-
PE	+	+	+	-
PP	+	+	+	+
Hydrochloric acid, > 30 - 37 % aqueous solution	Fluid Temperatures			
	20 °C	40 °C	60 °C	80 °C
PVC-U	++	++	++	-
PE	+	+	0	-
PP	0	0	0	0
Hydrochloric acid, > 37 %, aqueous solution	Fluid Temperatures			
	20 °C	40 °C	60 °C	80 °C
PVC-U	0	-		
PE	0	-		
PP	0	-		
Hydrocyanic acid	Fluid Temperatures			
	20 °C	40 °C	60 °C	80 °C
PVC-U	++	++	0	-
PE	++	++	++	-
PP	++	++	++	0
Hydrofluoric acid, <= 10 % aqueous solution	Fluid Temperatures			
	20 °C	40 °C	60 °C	80 °C
PVC-U	+	+	0	-
PE	+	+	0	-
PP	+	+	0	0

Chemical Resistance

	Fluid Temperatures			
	20 °C	40 °C	60 °C	80 °C
Hydrofluoric acid, > 40% - 75% aqueous solution				
PVC-U	-			
PE	+	+	0	-
PP	0	0		
Hydrofluoric acid, > 75 % aqueous solution				
PVC-U	-			
PE	-			
PP	-			
Hydrofluoric acid, 10% - 40 % aqueous solution				
PVC-U	0	0	-	
PE	+	+	0	-
PP	+	+	0	0
Hydrogen chloride, gaseous				
PVC-U	++	++	0	-
PE	++	++	0	-
PP	++	++	0	-
Hydrogen peroxide, < 5 % aqueous solution				
PVC-U	++	++	-	
PE	+	0	-	
PP	0	-		
Hydrogen peroxide, >= 5 % aqueous solution				
PVC-U	++	++	-	
PE	0	-		
PP	-			
Hydrogen Sulfide gaseous				
PVC-U	++	++	0	-
PE	++	++	0	-
PP	++	++	++	0
Hydrogen sulfide, aqueous saturated solution				
PVC-U	++	++	0	-
PE	++	++	++	-
PP	++	++	++	0
Hydrogen, gas				
PVC-U	++	++	++	-
PE	++	++	++	-
PP	++	++	++	0
Hydroquinone, cold saturated aqueous solution				
PVC-U	++	0	-	
PE	++	0	-	
PP	++	0	-	
Iron salts, aqueous, saturated solutions				
PVC-U	++	++	++	-
PE	++	++	++	-
PP	++	++	++	++
Isobutylacetate				
PVC-U	-			
PE	++	0	-	
PP	++	0	-	
Isocetane				
	20 °C	40 °C	60 °C	80 °C

PVC-U	++	0	-	
PE	++	0	-	
PP	++	0	-	
Isopropyl alcohol				
	20 °C	40 °C	60 °C	80 °C
PVC-U	++	0	-	
PE	++	++	0	-
PP	++	++	0	-
Lactic acid, aqueous solution				
	20 °C	40 °C	60 °C	80 °C
PVC-U	++	0	0	-
PE	+	+	+	-
PP	+	+	+	0
Lead Acetate				
	20 °C	40 °C	60 °C	80 °C
PVC-U	++	++	++	-
PE	++	++	++	-
PP	++	++	++	0
Linseed oil				
	20 °C	40 °C	60 °C	80 °C
PVC-U	++	++	0	-
PE	++	++	0	-
PP	++	++	++	0
Lithium salts, aqueous saturated solutions				
	20 °C	40 °C	60 °C	80 °C
PVC-U	++	++	++	-
PE	++	++	++	-
PP	++	++	++	++
Magnesium salts, aqueous, saturated solutions				
	20 °C	40 °C	60 °C	80 °C
PVC-U	++	++	++	-
PE	++	++	++	-
PP	++	++	++	++
Maleic acid, cold saturated, aqueous solution				
	20 °C	40 °C	60 °C	80 °C
PVC-U	++	0		
PE	++	++	0	
PP	++	++	0	
Mercury salts, aqueous, saturated solutions				
	20 °C	40 °C	60 °C	80 °C
PVC-U	++	++	0	-
PE	++	++	++	-
PP	++	++	++	++
Methane, gaseous				
	20 °C	40 °C	60 °C	80 °C
PVC-U	++	0		
PE	++	0		
PP	++	0		
Methanol				
	20 °C	40 °C	60 °C	80 °C
PVC-U	++	++	0	-
PE	++	++	++	-
PP	++	++	++	0
Methyl acetate				
	20 °C	40 °C	60 °C	80 °C
PVC-U	-			
PE	++	++	0	
PP	++	++	0	
Methyl Amine, 32 % aqueous solution				
	20 °C	40 °C	60 °C	80 °C
PVC-U	0			
PE	++	0		
PP	++	0		
Methyl bromide, gaseous				
	20 °C	40 °C	60 °C	80 °C

Chemical Resistance

PVC-U	-			
PE	-			
PP	-			
Methyl ethyl ketone	Fluid Temperatures			
	20 °C	40 °C	60 °C	80 °C
PVC-U	-			
PE	++	0		
PP	++	0		
Methyl isobutyl ketone	Fluid Temperatures			
	20 °C	40 °C	60 °C	80 °C
PVC-U	-			
PE	++	0		
PP	++	0		
Methyl acetate	Fluid Temperatures			
	20 °C	40 °C	60 °C	80 °C
PVC-U	-			
PE	++	++	0	
PP	++	++	0	
Methyl Amine, 32 % aqueous solution	Fluid Temperatures			
	20 °C	40 °C	60 °C	80 °C
PVC-U	0			
PE	++	0		
PP	++	0		
Methyl bromide, gaseous	Fluid Temperatures			
	20 °C	40 °C	60 °C	80 °C
PVC-U	-			
PE	-			
PP	-			
Methyl ethyl ketone	Fluid Temperatures			
	20 °C	40 °C	60 °C	80 °C
PVC-U	-			
PE	++	0		
PP	++	0		
Methyl isobutyl ketone	Fluid Temperatures			
	20 °C	40 °C	60 °C	80 °C
PVC-U	-			
PE	++	0		
PP	++	0		
Methyl methacrylate	Fluid Temperatures			
	20 °C	40 °C	60 °C	80 °C
PVC-U	-			
PE	++	++	0	
PP	++	++	0	
Milk	Fluid Temperatures			
	20 °C	40 °C	60 °C	80 °C
PVC-U	++	++	++	-
PE	++	++	++	-
PP	++	++	++	++
Mineral oil	Fluid Temperatures			
	20 °C	40 °C	60 °C	80 °C
PVC-U	++	++	0	
PE	++	++	0	
PP	++	++	0	
50% Chromic acid / 15% sulfuric acid / 35% water	Fluid Temperatures			
	20 °C	40 °C	60 °C	80 °C
PVC-U	0	0	-	
PE	-			
PP	-			
Mixed acids: 15% nitric / 15% hydrofluoric / 18% sulfuric	Fluid Temperatures			
	20 °C	40 °C	60 °C	80 °C
PVC-U	0			
PE	-			
PP	-			
Mixed acids: 30% sulfuric / 60% phosphoric / 10% water	Fluid Temperatures			
	20 °C	40 °C	60 °C	80 °C

PVC-U	++	++	0	-
PE	++	++	0	-
PP	++	++	++	0
Mixed acids: sulfuric / nitric / water, various concentrations	Fluid Temperatures			
	20 °C	40 °C	60 °C	80 °C
PVC-U	0			
PE	0			
PP	0			
N-Methylpyrrolidon	Fluid Temperatures			
	20 °C	40 °C	60 °C	80 °C
PVC-U	-			
PE	++	0		
PP	++	0		
N,N-Dimethylaniline	Fluid Temperatures			
	20 °C	40 °C	60 °C	80 °C
PVC-U	-			
PE	++	0		
PP	0			
Nickel salts, aqueous, saturated solutions	Fluid Temperatures			
	20 °C	40 °C	60 °C	80 °C
PVC-U	++	++	0	-
PE	++	++	++	-
PP	++	++	++	++
Nitrating acid	Fluid Temperatures			
	20 °C	40 °C	60 °C	80 °C
PVC-U	0	0	-	
PE	-			
PP	-			
Nitric acid, > 30 - 55 % aqueous solution	Fluid Temperatures			
	20 °C	40 °C	60 °C	80 °C
PVC-U	+	+	-	
PE	-			
PP	-			
Nitric acid, > 6 - 20 % aqueous solution	Fluid Temperatures			
	20 °C	40 °C	60 °C	80 °C
PVC-U	++	++	++	-
PE	0	-		
PP	0	0		
Nitric acid, >20 - 30 % aqueous solution	Fluid Temperatures			
	20 °C	40 °C	60 °C	80 °C
PVC-U	++	++	++	-
PE	0	-		
PP	0	0		
Nitric acid, >55 - 65 % aqueous solution	Fluid Temperatures			
	20 °C	40 °C	60 °C	80 °C
PVC-U	0	0	-	
PE	-			
PP	-			
Nitric acid, ≤ 6 % aqueous solution	Fluid Temperatures			
	20 °C	40 °C	60 °C	80 °C
PVC-U	++	++	++	-
PE	0	-		
PP	0	0	0	
Nitrobenzene	Fluid Temperatures			
	20 °C	40 °C	60 °C	80 °C
PVC-U	-			
PE	++	0		
PP	++	0		
Nitrogen Gas	Fluid Temperatures			
	20 °C	40 °C	60 °C	80 °C
PVC-U	++	++	++	-
PE	++	++	++	-
PP	++	++	++	++

Chemical Resistance

Nitrotoluene (o-, m-, p-)	Fluid Temperatures				
	20 °C	40 °C	60 °C	80 °C	
PVC-U	-				
PE	++	0			
PP	0				
Nitrous acid	Fluid Temperatures				
	20 °C	40 °C	60 °C	80 °C	
	PVC-U	++	++	0	-
	PE	++	0		
	PP	++	0		
Nitrous gases (Nitric oxide),	Fluid Temperatures				
	20 °C	40 °C	60 °C	80 °C	
	PVC-U	++	0		
	PE	0			
	PP	0			
Oleic acid	Fluid Temperatures				
	20 °C	40 °C	60 °C	80 °C	
	PVC-U	++	++	0	-
	PE	++	0		
	PP	++	0		
Oleum, <= 10 % SO3	Fluid Temperatures				
	20 °C	40 °C	60 °C	80 °C	
	PVC-U	-			
	PE	-			
	PP	-			
Olive oil	Fluid Temperatures				
	20 °C	40 °C	60 °C	80 °C	
	PVC-U	++	++	0	-
	PE	+	+	0	
	PP	+	+	0	
Oxygen, gaseous	Fluid Temperatures				
	20 °C	40 °C	60 °C	80 °C	
	PVC-U	++	++	++	-
	PE	++	++	0	
	PP	++	++	0	
Palm oil, palm nut oil	Fluid Temperatures				
	20 °C	40 °C	60 °C	80 °C	
	PVC-U	++	++	++	-
	PE	++	++	++	-
	PP	++	0		
Peracetic acid, > 10 %	Fluid Temperatures				
	20 °C	40 °C	60 °C	80 °C	
	PVC-U	0	0		
	PE	0			
	PP	0			
Peracetic acid	Fluid Temperatures				
	20 °C	40 °C	60 °C	80 °C	
	PVC-U	0	0		
	PE	0			
	PP	0			
Perchloric acid, <= 70 % aqueous solution	Fluid Temperatures				
	20 °C	40 °C	60 °C	80 °C	
	PVC-U	0			
	PE	0			
	PP	0			
Peroxo monosulfuric acid, 0-10 % aqueous solution	Fluid Temperatures				
	20 °C	40 °C	60 °C	80 °C	
	PVC-U	0			
	PE	-			
	PP	-			
Phenol, <= 10 % aqueous solution	Fluid Temperatures				
	20 °C	40 °C	60 °C	80 °C	
	PVC-U	0			
	PE	++	++	0	
	PP	++	++	0	
Phosphoric acid, <= 60 % aqueous solution	Fluid Temperatures				
	20 °C	40 °C	60 °C	80 °C	
	PVC-U	++	++	++	-
	PE	++	++	++	-
	PP	++	++	++	++

Phosphoric acid, >60-85 % aqueous solution	20 °C	40 °C	60 °C	80 °C	
	PVC-U	++	++	++	-
PE	+	+	0		
PP	+	+	+	0	
Phosphoric acid, >85-95 % aqueous solution	Fluid Temperatures				
	20 °C	40 °C	60 °C	80 °C	
	PVC-U	+	+	0	-
	PE	+	+	0	
	PP	+	+	0	
Phosphorous chlorides: -trichloride -pentachloride -oxichloride	Fluid Temperatures				
	20 °C	40 °C	60 °C	80 °C	
	PVC-U	-			
	PE	0			
	PP	0			
Photographic fixer, commercial solutions	Fluid Temperatures				
	20 °C	40 °C	60 °C	80 °C	
	PVC-U	++	++	0	-
	PE	+	+	0	-
	PP	+	+	0	
Phthalic acid, aqueous saturated solution	Fluid Temperatures				
	20 °C	40 °C	60 °C	80 °C	
	PVC-U	++	0		
	PE	++	++	++	-
	PP	++	++	++	0
Potassium aluminium salts(alum), aqueous, saturated solutions	Fluid Temperatures				
	20 °C	40 °C	60 °C	80 °C	
	PVC-U	++	++	++	-
	PE	++	++	++	-
	PP	++	++	++	++
Potassium cyanide, sodium Cyanide, aqueous solutions	Fluid Temperatures				
	20 °C	40 °C	60 °C	80 °C	
	PVC-U	++	++	++	-
	PE	++	++	++	-
	PP	++	++	++	++
Potassium formiate, aqueous solutions	Fluid Temperatures				
	20 °C	40 °C	60 °C	80 °C	
	PVC-U	++	++	0	-
	PE	++	++	++	-
	PP	++	++	++	++
Potassium hydroxide <= 50 % aqueous solution	Fluid Temperatures				
	20 °C	40 °C	60 °C	80 °C	
	PVC-U	++	++	++	-
	PE	++	++	++	-
	PP	+	+	+	+
Potassium hypochlorite, <=16% active Chlorine	Fluid Temperatures				
	20 °C	40 °C	60 °C	80 °C	
	PVC-U	+	+	-	
	PE	0			
	PP	0			
Potassium Permanganate, aqueous solution	Fluid Temperatures				
	20 °C	40 °C	60 °C	80 °C	
	PVC-U	+	+	0	-
	PE	0	0	-	
	PP	0	0	-	
Potassium persulphate, aqueous solution	Fluid Temperatures				
	20 °C	40 °C	60 °C	80 °C	
	PVC-U	++	++	++	-
	PE	++	++	++	-
	PP	++	++	++	++

Chemical Resistance

PVC-U	++	++	0	-
PE	++	++	++	-
PP	++	++	++	0
Propane, gaseous				
Fluid Temperatures				
	20 °C	40 °C	60 °C	80 °C
PVC-U	++	0		
PE	++	++	0	
PP	++	0		
Propionic acid				
Fluid Temperatures				
	20 °C	40 °C	60 °C	80 °C
PVC-U	++	0		
PE	++	0		
PP	++	0		
Propionic acid, 50% aqueous solution				
Fluid Temperatures				
	20 °C	40 °C	60 °C	80 °C
PVC-U	++	++	0	-
PE	++	++	++	-
PP	++	++	++	0
Propylene glycol				
Fluid Temperatures				
	20 °C	40 °C	60 °C	80 °C
PVC-U	-			
PE	+	+	0	-
PP	+	+	+	0
Propylene glycol <= 50% aqueous solution				
Fluid Temperatures				
	20 °C	40 °C	60 °C	80 °C
PVC-U	++	++	0	-
PE	+	+	0	-
PP	+	+	+	0
Pyridine				
Fluid Temperatures				
	20 °C	40 °C	60 °C	80 °C
PVC-U	-			
PE	++	0		
PP	0			
Salicylaldehyde				
Fluid Temperatures				
	20 °C	40 °C	60 °C	80 °C
PVC-U	0	-		
PE	0			
PP	0			
Silicic acids				
Fluid Temperatures				
	20 °C	40 °C	60 °C	80 °C
PVC-U	++	++	++	-
PE	++	++	++	-
PP	++	++	++	++
Silicone oils				
Fluid Temperatures				
	20 °C	40 °C	60 °C	80 °C
PVC-U	++	0		
PE	++	++	++	-
PP	++	++	++	++
Silver salts, aqueous saturated solutions				
Fluid Temperatures				
	20 °C	40 °C	60 °C	80 °C
PVC-U	++	++	++	-
PE	++	++	++	-
PP	++	++	++	++
Sodium borate, aqueous solution				
Fluid Temperatures				
	20 °C	40 °C	60 °C	80 °C
PVC-U	++	++	0	
PE	++	++	++	-
PP	++	++	++	++
Sodium Carbonate, aqueous solutions				
Fluid Temperatures				
	20 °C	40 °C	60 °C	80 °C
PVC-U	++	++	++	-
PE	++	++	++	-
PP	++	++	++	++
Sodium Chloride, aqueous saturated solution				
Fluid Temperatures				
	20 °C	40 °C	60 °C	80 °C
PVC-U	++	++	++	-

PE	++	++	++	-
PP	++	++	++	++
Sodium chlorite, aqueous solution				
Fluid Temperatures				
	20 °C	40 °C	60 °C	80 °C
PVC-U	++	++	++	-
PE	+	+	0	
PP	+	+	0	
Sodium Chromate, diluted aqueous solution				
Fluid Temperatures				
	20 °C	40 °C	60 °C	80 °C
PVC-U	++	++	0	
PE	0			
PP	0			
Sodium hydrogen sulfite,				
Fluid Temperatures				
	20 °C	40 °C	60 °C	80 °C
PVC-U	++	++	++	-
PE	++	++	++	-
PP	++	++	++	++
Sodium hydroxide, <=10% aqueous solution				
Fluid Temperatures				
	20 °C	40 °C	60 °C	80 °C
PVC-U	++	++	+	-
PE	++	++	++	-
PP	+	+	+	0
Sodium hydroxide, > 50 %				
Fluid Temperatures				
	20 °C	40 °C	60 °C	80 °C
PVC-U	0	0	-	
PE	0	0	0	-
PP	0	0	0	0
Sodium hydroxide, >10-50 % aqueous solution				
Fluid Temperatures				
	20 °C	40 °C	60 °C	80 °C
PVC-U	++	++	0	-
PE	++	++	++	-
PP	+	+	0	0
Sodium Hypochlorite from electrochlorination plants				
Fluid Temperatures				
	20 °C	40 °C	60 °C	80 °C
PVC-U	0			
PE	0			
PP	0			
Sodium hypochlorite, < 0.5 ppm active chlorine				
Fluid Temperatures				
	20 °C	40 °C	60 °C	80 °C
PVC-U	++	++	0	-
PE	++	++	0	-
PP	++	++	0	-
Sodium hypochlorite, <= 6 % active chlorine				
Fluid Temperatures				
	20 °C	40 °C	60 °C	80 °C
PVC-U	+	+	0	-
PE	-			
PP	-			
Sodium hypochlorite, > 6 % active chlorine				
Fluid Temperatures				
	20 °C	40 °C	60 °C	80 °C
PVC-U	+	+	-	
PE	-			
PP	-			
Sodium hypochlorite, 0.5 - 2 ppm active chlorine				
Fluid Temperatures				
	20 °C	40 °C	60 °C	80 °C
PVC-U	++	++	0	-
PE	++	++	-	
PP	++	++	-	
Sodium persulfate, aqueous, cold saturated solution				
Fluid Temperatures				
	20 °C	40 °C	60 °C	80 °C
PVC-U	++	++	0	-
PE	++	++	++	-
PP	++	++	++	0

Chemical Resistance

	Fluid Temperatures			
	20 °C	40 °C	60 °C	80 °C
Sodium salts, aqueous, saturated solutions				
PVC-U	++	++	++	-
PE	++	++	++	-
PP	++	++	++	++
Starch solution, aqueous solutions				
PVC-U	++	++	++	-
PE	++	++	++	-
PP	++	++	++	++
Styrene				
PVC-U	-			
PE	0			
PP	0			
Succinic acid, aqueous solutions				
PVC-U	++	++	++	-
PE	++	++	++	-
PP	++	++	++	0
Sulfuric acid, <= 25% aqueous solution				
PVC-U	++	++	++	-
PE	++	++	++	-
PP	+	+	+	0
Sulfuric acid, > 25-50% solution				
PVC-U	++	++	++	-
PE	++	++	++	-
PP	+	+	+	+
Sulfuric acid, > 50 - 70% solution				
PVC-U	+	+	+	-
PE	++	++	++	-
PP	+	+	+	0
Sulfuric acid, > 70 - 78% solution				
PVC-U	+	+	-	-
PE	++	++	++	-
PP	+	+	0	0
Sulfuric Acid, > 78 - 93% solution				
PVC-U	+	+	-	-
PE	-			
PP	-			
Sulfuric acid, > 93 - 96% solution				
PVC-U	+	+	-	-
PE	-			
PP	-			
Sulfuric acid, > 96% - 98% solution				
PVC-U	+	0	-	-
PE	-			
PP	-			
Sulfurous acid, aqueous solution				
PVC-U	++	++	0	-
PE	++	++	0	-
PP	++	++	0	-
Sulfuryl chloride				
PVC-U	-			
PE	-			
PP	-			
Sulphur dioxide, gaseous, dry and moist				
	20 °C	40 °C	60 °C	80 °C

PVC-U	0			
PE	0			
PP	0			
Tannic acid, aqueous solution				
	20 °C	40 °C	60 °C	80 °C
PVC-U	++	0		
PE	++	0		
PP	++	0		
Tartaric acid, <=10% aqueous solution				
	20 °C	40 °C	60 °C	80 °C
PVC-U	++	++	++	-
PE	++	++	++	-
PP	++	++	++	0
Tetrachloroethane				
	20 °C	40 °C	60 °C	80 °C
PVC-U	-			
PE	-			
PP	-			
Tetrachloroethylene				
	20 °C	40 °C	60 °C	80 °C
PVC-U	-			
PE	0			
PP	0			
Tetrachloromethane				
	20 °C	40 °C	60 °C	80 °C
PVC-U	-			
PE	-			
PP	-			
Tetrahydrofurane				
	20 °C	40 °C	60 °C	80 °C
PVC-U	-			
PE	0			
PP	0			
Tetramethyl ammoniumhydroxide				
	20 °C	40 °C	60 °C	80 °C
PVC-U	++	0	0	-
PE	++	0	0	-
PP	++	0	0	
Tin (II) Chloride, aqueous saturated solution				
	20 °C	40 °C	60 °C	80 °C
PVC-U	++	++	++	-
PE	++	++	++	-
PP	++	++	++	0
Toluene				
	20 °C	40 °C	60 °C	80 °C
PVC-U	-			
PE	0			
PP	0			
Trichloroacetic acid, aqueous solutions				
	20 °C	40 °C	60 °C	80 °C
PVC-U	0			
PE	++	++	0	
PP	++	++	0	
Trichloroethane				
	20 °C	40 °C	60 °C	80 °C
PVC-U	-			
PE	0			
PP	0			
Trichloroethylene				
	20 °C	40 °C	60 °C	80 °C
PVC-U	-			
PE	-			
PP	-			
Trichloromethane				
	20 °C	40 °C	60 °C	80 °C
PVC-U	-			
PE	0			
PP	0			

Chemical Resistance

	Fluid Temperatures			
	20 °C	40 °C	60 °C	80 °C
Triethylamine	-	-	-	-
PVC-U	-	-	-	-
PE	0	-	-	-
PP	0	-	-	-
Trifluoroacetic acid, aqueous solution	Fluid Temperatures			
	20 °C	40 °C	60 °C	80 °C
PVC-U	-	-	-	-
PE	++	0	-	-
PP	++	0	-	-
Turpentine oil	Fluid Temperatures			
	20 °C	40 °C	60 °C	80 °C
PVC-U	0	-	-	-
PE	0	-	-	-
PP	-	-	-	-
Urea, aqueous solution	Fluid Temperatures			
	20 °C	40 °C	60 °C	80 °C
PVC-U	++	++	0	-
PE	++	++	++	-
PP	++	++	++	0
Urine	Fluid Temperatures			
	20 °C	40 °C	60 °C	80 °C
PVC-U	++	++	0	-
PE	++	++	++	-
PP	++	++	++	0
Vinyl acetate	Fluid Temperatures			
	20 °C	40 °C	60 °C	80 °C
PVC-U	-	-	-	-
PE	++	++	0	-
PP	++	0	-	-
Vinyl Chloride gas	Fluid Temperatures			
	20 °C	40 °C	60 °C	80 °C
PVC-U	-	-	-	-
PE	-	-	-	-
PP	-	-	-	-

	Fluid Temperatures			
	20 °C	40 °C	60 °C	80 °C
Mineral water	Fluid Temperatures			
	20 °C	40 °C	60 °C	80 °C
PVC-U	++	++	++	-
PE	++	++	++	-
PP	++	++	++	++
Potable Water	Fluid Temperatures			
	20 °C	40 °C	60 °C	80 °C
PVC-U	++	++	++	-
PE	++	++	++	-
PP	++	++	++	++
Sea water	Fluid Temperatures			
	20 °C	40 °C	60 °C	80 °C
PVC-U	++	++	++	-
PE	++	++	++	-
PP	++	++	++	++
Water - distilled - deionised	Fluid Temperatures			
	20 °C	40 °C	60 °C	80 °C
PVC-U	++	++	++	-
PE	++	++	++	-
PP	++	++	++	++
Water, drinking, chlorinated, ≤ 0.1 ppm Chlorine	Fluid Temperatures			
	20 °C	40 °C	60 °C	80 °C
PVC-U	++	++	++	-
PE	++	++	++	-
PP	++	++	++	++
Xylene	Fluid Temperatures			
	20 °C	40 °C	60 °C	80 °C
PVC-U	-	-	-	-
PE	-	-	-	-
PP	-	-	-	-
Zinc salts, aqueous saturated solutions	Fluid Temperatures			
	20 °C	40 °C	60 °C	80 °C
PVC-U	++	++	++	-
PE	++	++	++	-
PP	++	++	++	++

- ++ Resistant
- + Limited Resistance
- 0 Contact GF Hakan Plastik
- Not Resistant

GF Hakan Plastik Boru ve Profil Sanayi ve Ticaret A.Ş. has right to change all the technical values and visuals specified in this brochure. We do not accept responsibility for printing-related errors.

References

Shopping mall in UAE

Products

Silenta Premium +
Silenta 3A Pipes & Fittings



Governmental building in Türkiye

Products

Silenta Premium + Silenta
3A Pipes & Fittings



High rise hotel in Azerbaijan

Products

Silenta Premium Pipes & Fittings



High rise residential building in India

Products

Silenta Premium Pipes & Fittings



Airport in Saudi Arabia

Products

Silenta Premium Pipes & Fittings



Luxury residential housing in Malaysia

Products

Silenta 3A Fittings

Local support around the world

Georg Fischer Hakan Plastik Boru ve Profil San. Tic. A.Ş.
Ofishane Plaza Merkez Mh. Cendere Cd.
No:22 K:11 34400 Kağıthane / İstanbul Türkiye

Visit our webpage to get in touch with your local specialist:
www.gfps.com/tr

