

Uponor Tecto underfloor heating/ cooling system

EN

Technical information

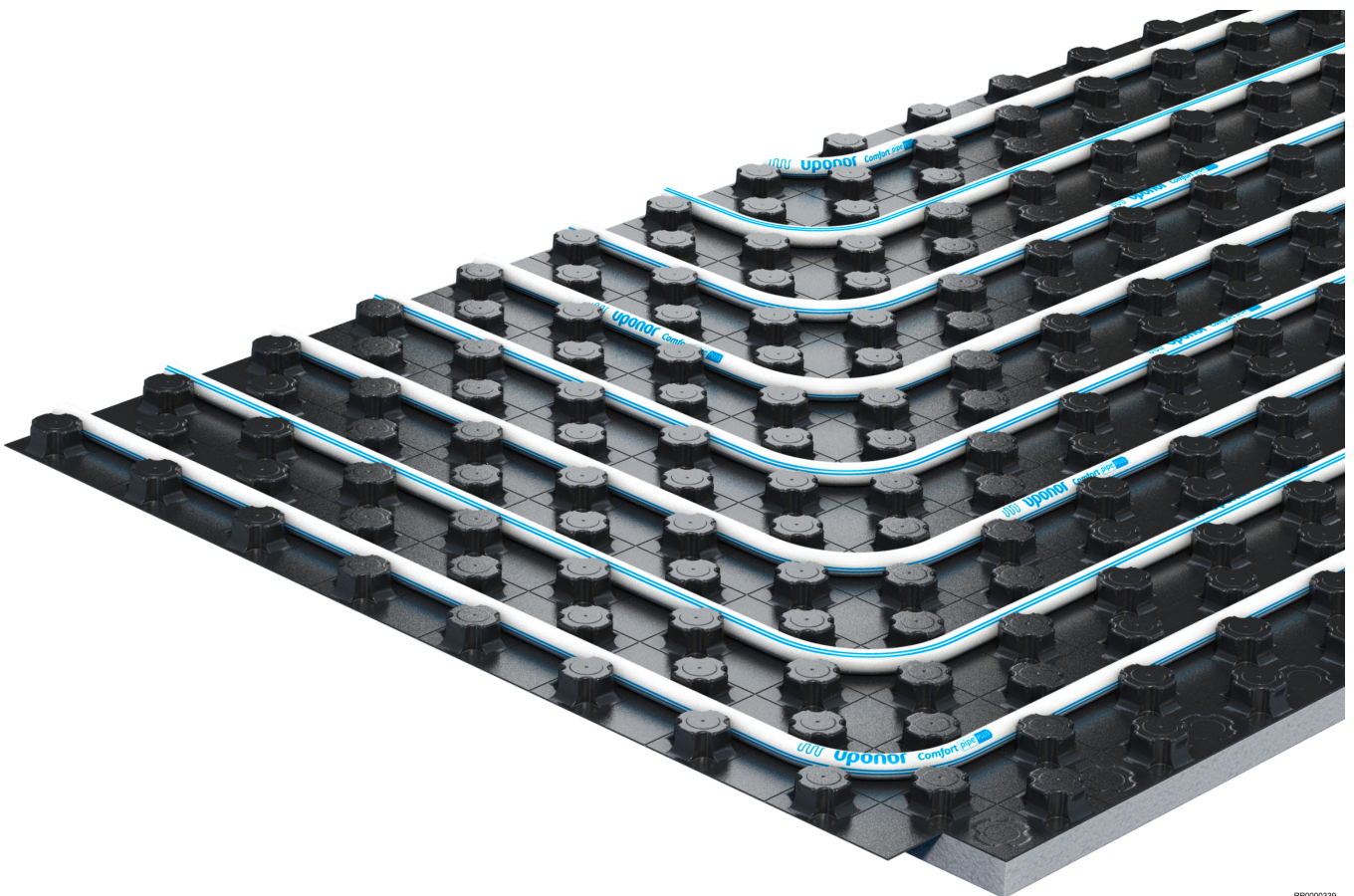

Table of contents

1	System description.....	3
1.1	Benefits.....	3
1.2	Components.....	3
1.3	Copyright and disclaimer.....	4
2	Planning/ design.....	5
2.1	Floor constructions.....	5
2.2	Dimensioning diagrams.....	6
2.3	Pressure drop diagrams.....	28
3	Installation.....	29
3.1	Installation process.....	29
4	Technical data.....	30
4.1	Technical specifications.....	30

1 System description



The Uponor Tecto is an underfloor heating and cooling system for single-family and commercial buildings. The system combines comfort, energy efficiency, and economy and is suitable for 14 mm - 17 mm Uponor pipe dimensions.

The Uponor Tecto is used for heating in winter and cooling in summer. The large area and a uniform heat distribution ensure a comfortable room temperature with mild radiant heat. The correct system pipe positioning at a fixed height, variable distance and uniform screed thickness is essential for comfortable and energy-efficient surface heating and cooling.

1.1 Benefits

- **Easy and flexible:** very few optimally matched system components
- **Reliable:** long-lifetime proven technology
- **Functional:** can be used both as a heating and cooling system
- **Compliant:** nub panels for a pipe fixation as per standards
- **Appliance:** laying distances in a 5 cm grid ensures a uniform heat or cold distribution
- **Suitable:** the foil will not be separated when the pipe is laid and is ideal for liquid screed
- **Accessible:** back-foamed EPS insulation is available in thicknesses 30 mm and 11 mm, and the system can be used in many areas

1.2 Components



Note

For more detailed information, product range and documentation, please visit the Uponor website: www.uponor.com.



Note

For detailed information about the product range, dimensions and availability, please refer to the Uponor price list.

Uponor Tecto nub panel ND 30-2

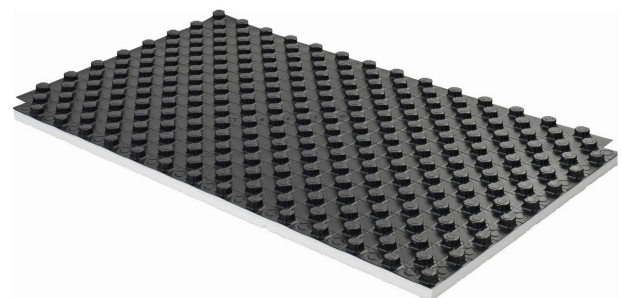

The Uponor Tecto nub panel ND 30-2 is a back-foamed EPS insulation panel, available with two-sided overlapping foil for a screed-tight connection and is suitable for 14 mm - 17 mm pipe dimensions.

It is integrated with thermal and impact sound insulation as per DIN EN 13163 and DIN 4108-10.

Live load up to 5 KN/m² can use this panel.

The pipe spacing is based on the heating or cooling requirements: 10 cm, 15 cm, 20 cm, 25 cm or 30 cm.

Uponor Tecto nub panel ND 11

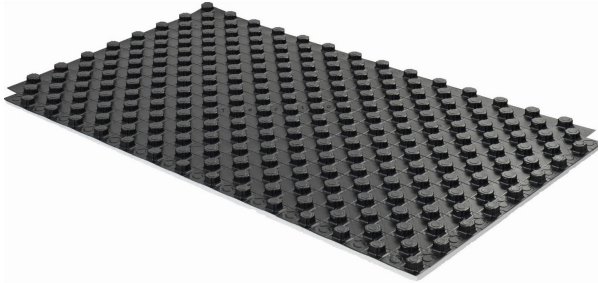

RP0000342

The Uponor Tecto nub panel ND 11 is a back-foamed EPS insulation panel, available with two-sided overlapping foil for a screed-tight connection and is suitable for 14 mm - 17 mm pipe dimensions.

It is integrated with thermal and without impact sound insulation as per DIN EN 13163 and DIN 4108-10.

Live load up to 30 KN/m² can use this panel.

The pipe spacing is based on the heating or cooling requirements: 10 cm, 15 cm, 20 cm, 25 cm or 30 cm.

Uponor Comfort Pipe PLUS



RP0000302

Uponor Comfort Pipe PLUS is a highly flexible PE-Xa pipe with 5 layers available in the dimensions 14 x 2,0 mm, 16 x 2,0 mm and 17 x 2,0 mm.

The pipe fulfils the requirements for oxygen diffusion tightness as per DIN 4726.

Uponor MLCP RED

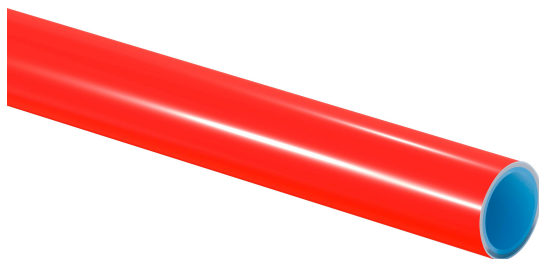

RP0000337

Uponor MLCP RED is a composite pipe which is stable and easy to install, available in the dimensions 14 x 1,6 mm and 16 x 2,0 mm.

The pipe fulfils the requirements for oxygen diffusion tightness as per DIN 4726.

Uponor jointing technology



Note

Only use fittings recommended by Uponor or its representatives.



RP0000338

Compression, Press, and Q&E joints are available to connect with respective pipes.

1.3 Copyright and disclaimer

“Uponor” is a registered trademark of Uponor Corporation.

Uponor has prepared this document solely for information purposes, images are only representations of the products. The content (text and images) of the document is protected by worldwide copyright laws and treaty provisions. You agree to comply with these when using the document. Modification or use of any of the content for any other purpose is a violation of Uponor’s copyright, trademark, and other proprietary rights.

While Uponor has made all effort to ensure that the document is accurate, the company does not guarantee or warrant the accuracy of the information. Uponor reserves the right to change the product portfolio and the related documentation without prior notification, in line with its policy of continuous improvement and development.

This is a generic, European-wide document version. The document may show products that are not available in your location for technical, legal, commercial, or other reasons. Therefore, check the Uponor product/price list in advance whether the product is deliverable in your location.

Always make sure that the system or product complies with current local standards and regulations. Uponor cannot guarantee the full compliance of the product portfolio and related documents with all local regulations, standards, or working methods.

Uponor disclaims all warranties related to the content of this document, expressed or implied, to the fullest extent permissible unless otherwise agreed or statutory.

Uponor is under no circumstances liable for any indirect, special, incidental, or consequential damage/loss that results from the use or inability to use the product portfolio and related documents.

For any questions or queries, please visit the local Uponor website or speak to your Uponor representative.

2 Planning/ design

2.1 Floor constructions

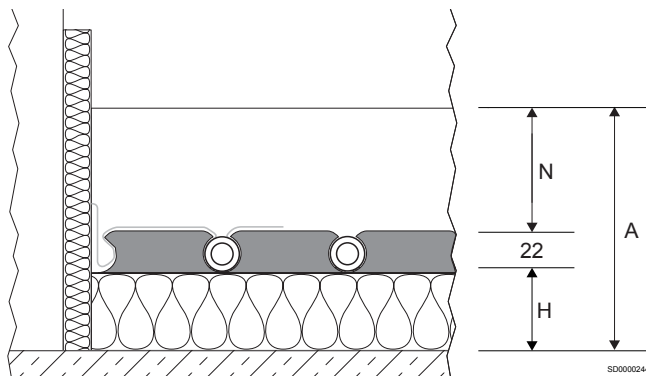

Additional planning information for special insulation requirements for non-residential buildings that deviate from this are described under "Thermal insulation requirements for radiant heating".

The masses per unit area of the ceiling and the screed as well as the dynamic stiffness of the Uponor heat and impact sound insulation have to be considered in providing the proof of impact sound insulation. The rated impact sound improvement of the floorings is calculated from the weight per unit area of the screed and the dynamic stiffness of the insulation or indicated by an equivalent test report.

Floor construction tables





These abbreviations are used in the following construction tables:

Item	Description
N	Minimum screed thickness
H	Insulation layer thickness (mm)
A	Structural height

As a result of combining insulations, the following constructions comply with the European minimum insulation requirements (refer to EN 1264-4 or EN 15377) for residential and non-residential buildings.

Abbreviations	Description
CT	Cement screed
CAF	Anhydride liquid screed
ΔLw [dB]	Impact sound improvement factor of flooring
$\Delta Lw,P$ [dB]	Impact sound improvement factor of tested flooring

Uponor Tecto nub panel ND 30-2

Thermal insulation requirements	Insulation layer thickness	Thermal resistance of insulation	Impact sound improvement factor of flooring ΔLw [dB]		Structural height A (2,0 kN/m ²) 	
			CT N \geq 45 [mm]	CAF ³⁾ N \geq 35 [mm]	CT N \geq 45 [mm]	CAF ³⁾ N \geq 35 [mm]
	H [mm]	$R_{\lambda, ins}$ [m ² K/W]				
Apartment ceiling separating heated rooms						
	Tecto EPS 30-2 = 30	0,75	30	29	\geq 97	\geq 87
EN 1264-4						
Floor slabs¹⁾, ceilings against unheated rooms in residential and non-residential buildings						
	Tecto EPS 30-2 = 30 EPS 035 DEO dm 20 = 20 Total H = 50	1,32	30	29	\geq 117	\geq 107
EN 1264-4						
Floor ceilings against outside air in residential and non-residential buildings ($\theta_i \geq 19$ °C)						
	Tecto EPS 30-2 = 30 EPS 035 DEO dm 45 = 45 Total H = 75	2,04	30	29	\geq 142	\geq 132
EN 1264-4						

Thermal insulation requirements	Insulation layer thickness	Thermal resistance of insulation	Impact sound improvement factor of flooring ΔL_w [dB]		Structural height A (5,0 kN/m ²) ²⁾	
	H [mm]		$R_{\lambda, ins}$ [m ² K/W]	CT N ≥ 75 [mm]	CAF ³⁾ N ≥ 65 [mm]	CT N ≥ 75 [mm]

Apartment ceiling separating heated rooms

	Tecto EPS 30-2 = 30	0,75	32	31	≥ 127	≥ 117
EN 1264-4						

Floor slabs¹⁾, ceilings against unheated rooms in residential and non-residential buildings

	Tecto EPS 30-2 = 30 EPS 035 DEO dm 20 = 20 Total H = 50	1,32	32	31	≥ 147	≥ 137
EN 1264-4						

Floor ceilings against outside air in residential and non-residential buildings ($\vartheta_i \geq 19$ °C)

	Tecto EPS 30-2 = 30 EPS 035 DEO dm 45 = 45 Total H = 75	2,04	32	31	≥ 172	≥ 162
EN 1264-4						

¹⁾ Observe additional construction height for structural waterproofing (refer to DIN 18533). Groundwater level ≥ 5 m.

²⁾ Observe dimensional tolerances at building site (refer to DIN 18202, Tab.2 and 3).

³⁾ Observe manufacturer's descriptions regarding the minimum screed thickness.

Uponor Tecto nub panel ND 11

Thermal insulation requirements	Insulation layer thickness	Thermal resistance of insulation	Impact sound improvement factor of flooring	Structural height A (2,0 kN/m ²) ²⁾		Structural height A (5,0 kN/m ²) ²⁾	
	H [mm]			$R_{\lambda, ins}$ [m ² K/W]	ΔL_w [dB]	CT N ≥ 45 [mm]	CAF ³⁾ N ≥ 35 [mm]

Apartment ceiling separating heated rooms

	Tecto EPS 11 = 11 EPS 035 DEO dm 20 = 20 Total H = 31	0,87	-	≥ 98	≥ 88	≥ 128	≥ 118
EN 1264-4							

Floor slabs¹⁾, ceilings against unheated rooms in residential and non-residential buildings

	Tecto EPS 11 = 11 EPS 035 DEO dm 35 = 35 Total H = 46	1,30	-	≥ 113	≥ 103	≥ 143	≥ 133
EN 1264-4							

Floor ceilings against outside air in residential and non-residential buildings ($\vartheta_i \geq 19$ °C)

	Tecto EPS 11 = 11 EPS 035 DEO dm 60 = 60 Total H = 71	2,01	-	≥ 138	≥ 128	≥ 168	≥ 158
EN 1264-4							

¹⁾ Observe additional construction height for structural waterproofing (refer to DIN 18533). Groundwater level ≥ 5 m.

²⁾ Observe dimensional tolerances at building site (refer to DIN 18202, Tab.2 and 3).

³⁾ Observe manufacturer's descriptions regarding the minimum screed thickness.

2.2 Dimensioning diagrams

Bathrooms, showers, toilets and the like are excluded when determining the design flow temperature.

The limit curves must not be exceeded.

$\Delta \vartheta_{H,G}$ is found through the limit curve for the occupied zone with the smallest pipe spacing.

The design supply water temperature maximum must be:

$$\Delta \vartheta_{V,des} = \Delta \vartheta_{H,G} + \Delta \vartheta_i + 2.5 \text{ K.}$$

In cooling mode the supply water temperature depends on the dew point temperature, therefore a humidity sensor has to be installed.

The following diagrams results are accurate and in accordance with EN 1264.

Abbreviations

These abbreviations are used in the following diagrams:

Abbreviations	Unit	Description
$A_{F,max}$	m^2	Maximum surface area of the heating/ cooling area
q_c	W/m^2	Specific thermal output of embedded cooling systems
q_{des}	W/m^2	Design specific thermal output of floor heating systems
$q_{G,max}$	W/m^2	Maximum limit of specific thermal output of floor heating systems
q_H	W/m^2	Specific thermal output of embedded heating systems, excluding floor heating
q_N	W/m^2	Standard thermal output of floor heating systems
$R_{\lambda,B}$	$m^2 K/W$	Thermal resistance of floor covering effective thermal resistance of carpeted covering
$R_{\lambda,ins}$	$m^2 K/W$	Thermal resistance of thermal insulation
s_u	mm	Thickness of the layer above the pipe
T	cm	Pipe spacing
$\vartheta_{F,max}$	$^{\circ}C$	Maximum floor surface temperature
ϑ_H	$^{\circ}C$	Average temperature of the heating medium
ϑ_i	$^{\circ}C$	Standard indoor room temperature
$\Delta\vartheta_c$	K	Temperature difference between room and cooling medium for cooling systems
$\Delta\vartheta_{C,N}$	K	Standard temperature difference between room and cooling medium for cooling systems
$\Delta\vartheta_H$	K	Temperature difference between heating medium and room
$\Delta\vartheta_{H,G}$	K	Limit temperature difference between heating medium and room for floor heating systems
$\Delta\vartheta_{H,N}$	K	Standard temperature difference between heating medium and room for heating systems, with the exception of floor heating
$\Delta\vartheta_{V,des}$	K	Design temperature difference between flow of heating medium and room of floor heating systems, determined by room with q_{max}
λ_u	W/mK	Thermal conductivity

Uponor Comfort Pipe PLUS 14 x 2,0 mm with screed load distribution layer (su = 35 mm with $\lambda_u = 1,2 \text{ W/mK}$)

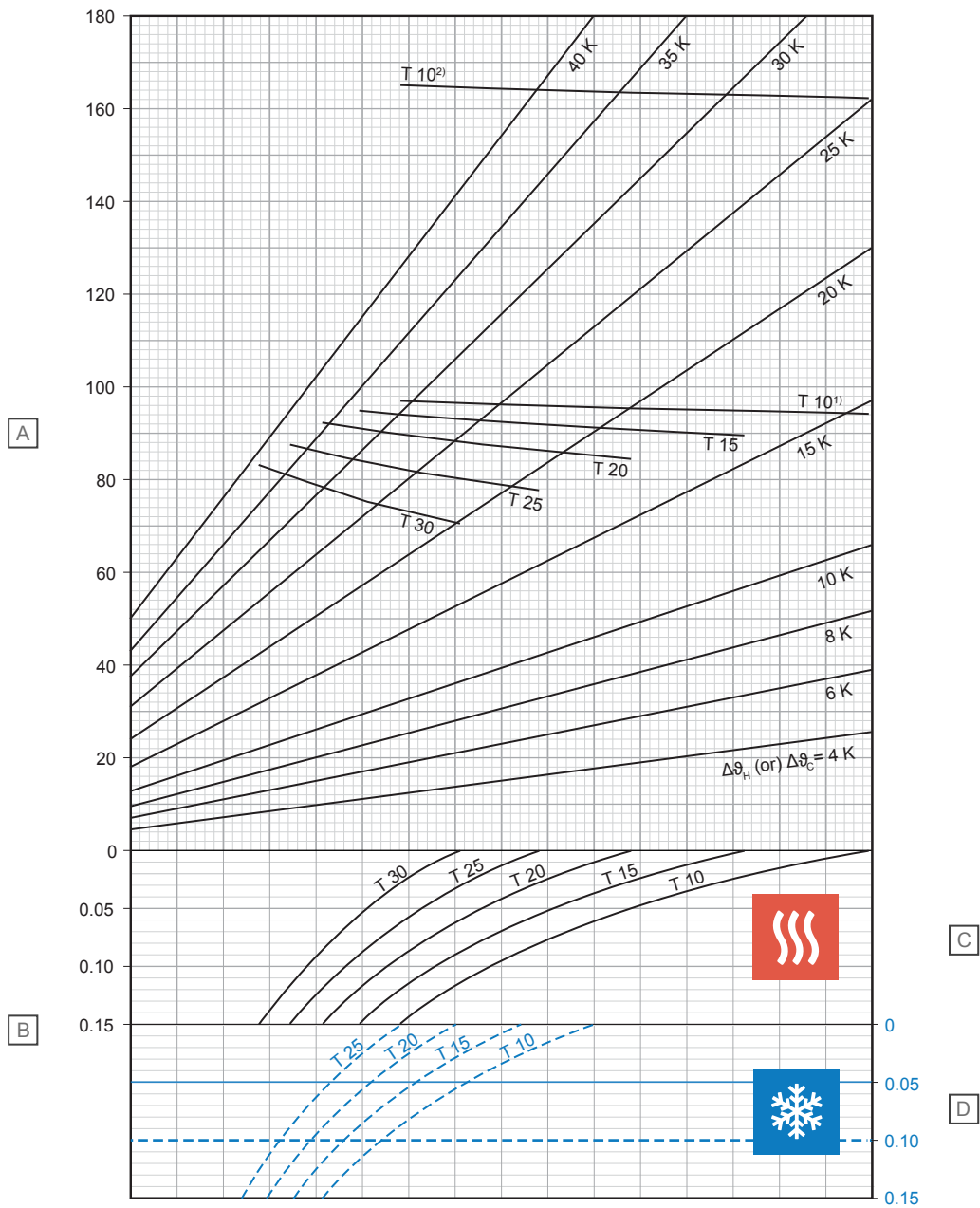

D10000241

Item	Unit	Description
A	W/m ²	Specific thermal heating or cooling output [q _H or q _C]
B	m ² K/W	Thermal resistance [R _{A,B}]

C - Heating

T (cm)	q _H (W/m ²)	Δθ _{H,N} (K)
10	94,3	14,4
15	89,6	16,1
20	84,5	17,7
25	77,6	18,8
30	70,3	19,8

D - Cooling

T (cm)	q _C (W/m ²)	Δθ _{C,N} (K)
10	36,2	8
15	32,1	8
20	28,4	8
25	25,2	8

¹⁾ Limit curve valid for ϑ_i 20 °C and $\vartheta_{F, \max}$ 29 °C or ϑ_i 24 °C and $\vartheta_{F, \max}$ 33 °C

²⁾ Limit curve valid for ϑ_i 20 °C and $\vartheta_{F, \max}$ 35 °C

Uponor Comfort Pipe PLUS 14 x 2,0 mm with screed load distribution layer (su = 45 mm with $\lambda_u = 1,2 \text{ W/mK}$)

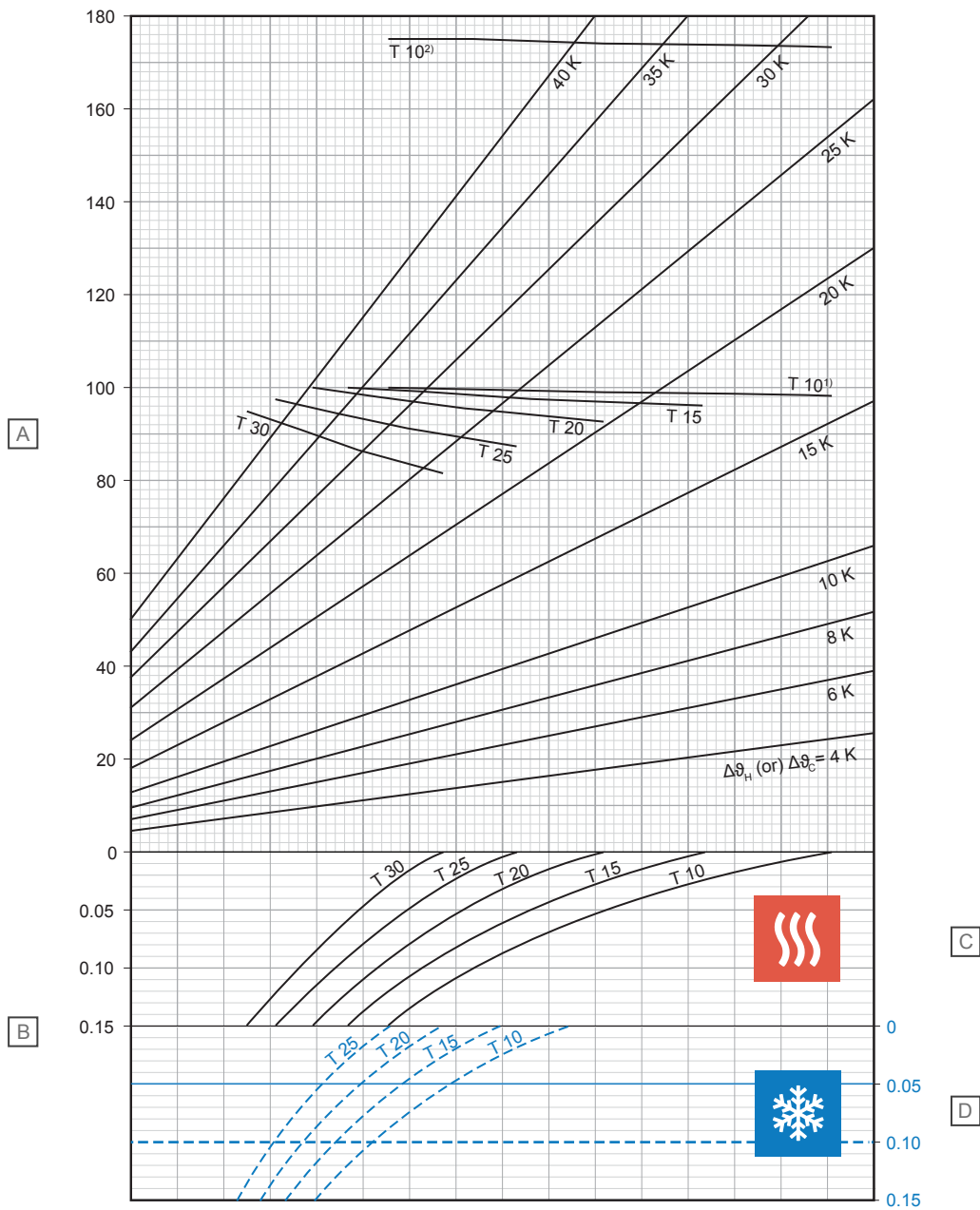

D10000242

Item	Unit	Description
A	W/m^2	Specific thermal heating or cooling output [q_H or q_C]
B	$\text{m}^2\text{K/W}$	Thermal resistance [$R_{\lambda,B}$]

C - Heating

T (cm)	$q_H \text{ (W/m}^2\text{)}$	$\Delta\theta_{H,N} \text{ (K)}$
10	98,4	15,9
15	95,9	18,1
20	92,7	20,2
25	87,4	22,0
30	81,6	23,7

D - Cooling

T (cm)	$q_C \text{ (W/m}^2\text{)}$	$\Delta\theta_{C,N} \text{ (K)}$
10	34,8	8
15	30,9	8
20	27,5	8
25	24,5	8

¹⁾ Limit curve valid for $\vartheta_i 20 \text{ }^\circ\text{C}$ and $\vartheta_{F, \text{max}} 29 \text{ }^\circ\text{C}$ or $\vartheta_i 24 \text{ }^\circ\text{C}$ and $\vartheta_{F, \text{max}} 33 \text{ }^\circ\text{C}$

²⁾ Limit curve valid for $\vartheta_i 20 \text{ }^\circ\text{C}$ and $\vartheta_{F, \text{max}} 35 \text{ }^\circ\text{C}$

Uponor Comfort Pipe PLUS 14 x 2,0 mm with screed load distribution layer (su = 65 mm with $\lambda u = 1,2 \text{ W/mK}$)

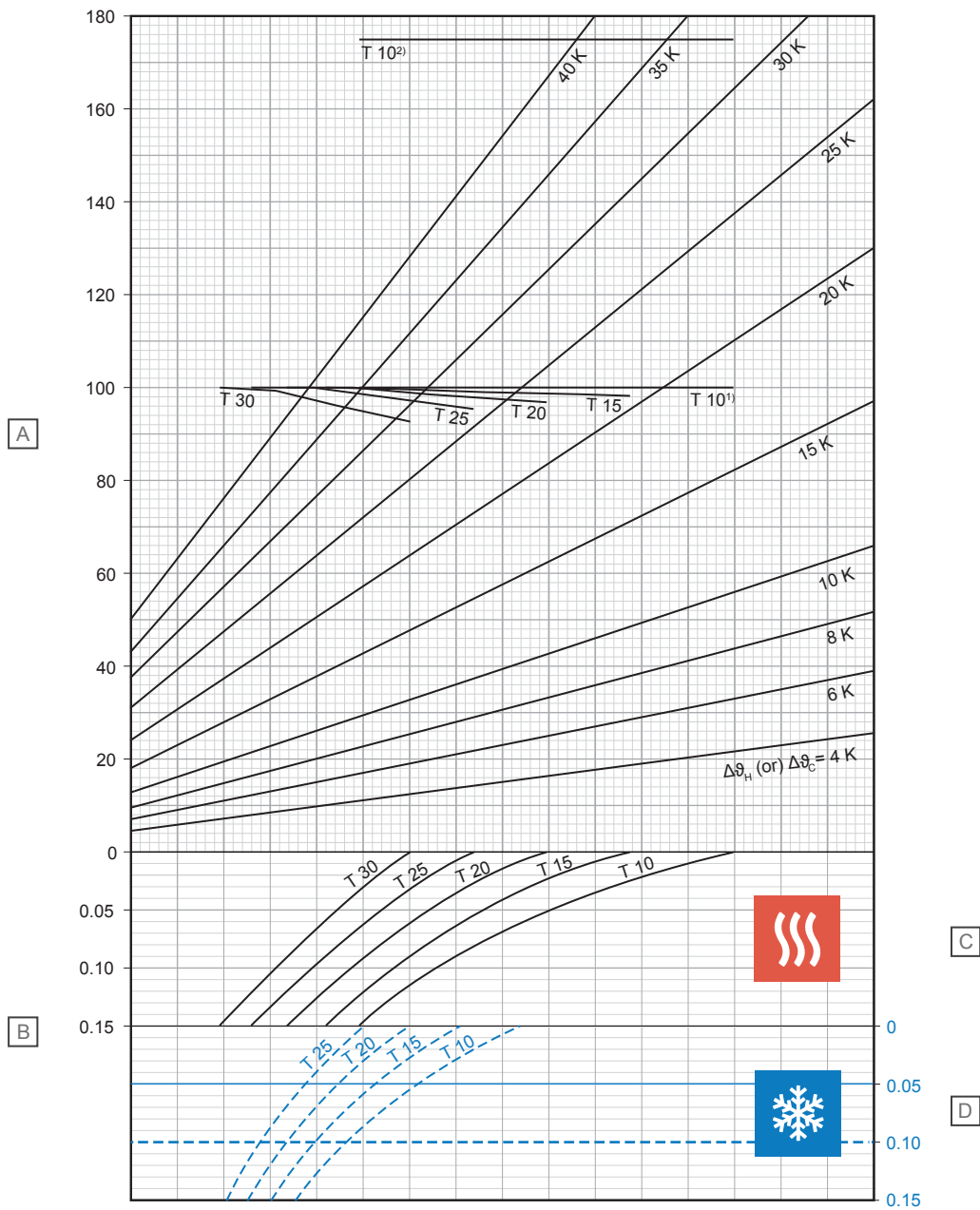

Item	Unit	Description
A	W/m²	Specific thermal heating or cooling output [q_H or q_C]
B	m²K/W	Thermal resistance [$R_{\lambda,B}$]

C - Heating

T (cm)	q_H (W/m²)	$\Delta\theta_{H,N}$ (K)
10	100,0	18,2
15	98,4	20,6
20	97,0	23,2
25	95,5	26,1
30	92,8	28,9

D - Cooling

T (cm)	q_C (W/m²)	$\Delta\theta_{C,N}$ (K)
10	31,9	8
15	28,6	8
20	25,6	8
25	23,0	8

¹⁾ Limit curve valid for $\vartheta_i 20 \text{ °C}$ and $\vartheta_{F, \max} 29 \text{ °C}$ or $\vartheta_i 24 \text{ °C}$ and $\vartheta_{F, \max} 33 \text{ °C}$

²⁾ Limit curve valid for $\vartheta_i 20 \text{ °C}$ and $\vartheta_{F, \max} 35 \text{ °C}$

Uponor Comfort Pipe PLUS 14 x 2,0 mm with screed load distribution layer (su = 75 mm with $\lambda u = 1,2 \text{ W/mK}$)

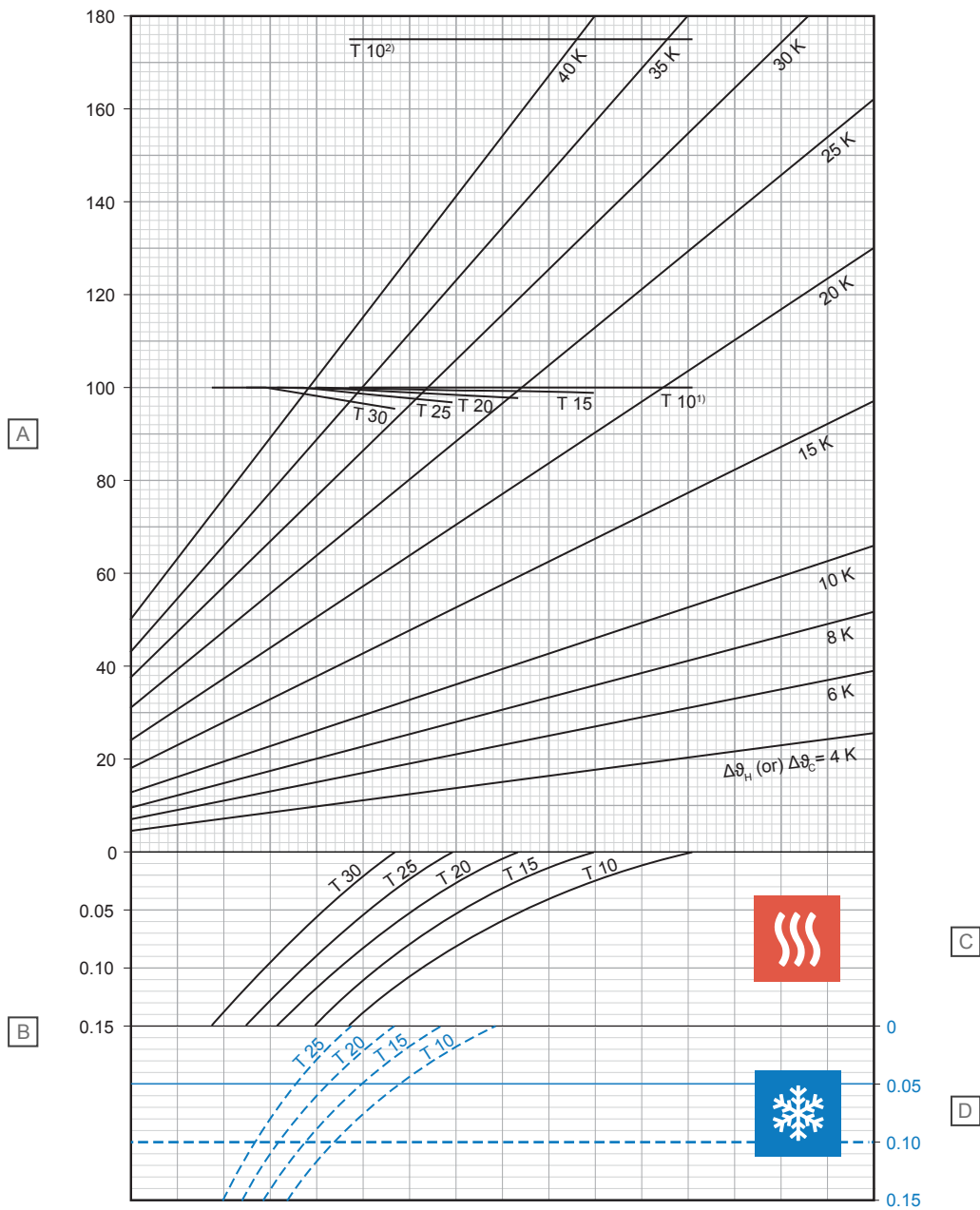

D10000244

Item	Unit	Description
A	W/m ²	Specific thermal heating or cooling output [q_H or q_C]
B	m ² K/W	Thermal resistance [$R_{\lambda,B}$]

C - Heating

T (cm)	q_H (W/m ²)	$\Delta\theta_{H,N}$ (K)
10	100,0	19,2
15	99,0	21,9
20	97,9	24,6
25	96,9	27,6
30	95,5	30,9

D - Cooling

T (cm)	q_C (W/m ²)	$\Delta\theta_{C,N}$ (K)
10	30,6	8
15	27,5	8
20	24,7	8
25	22,3	8

¹) Limit curve valid for ϑ_i 20 °C and $\vartheta_{F,max}$ 29 °C or ϑ_i 24 °C and $\vartheta_{F,max}$ 33 °C

²) Limit curve valid for ϑ_i 20 °C and $\vartheta_{F,max}$ 35 °C

Uponor Comfort Pipe PLUS 16 x 2,0 mm with screed load distribution layer (su = 35 mm with $\lambda_u = 1,2 \text{ W/mK}$)

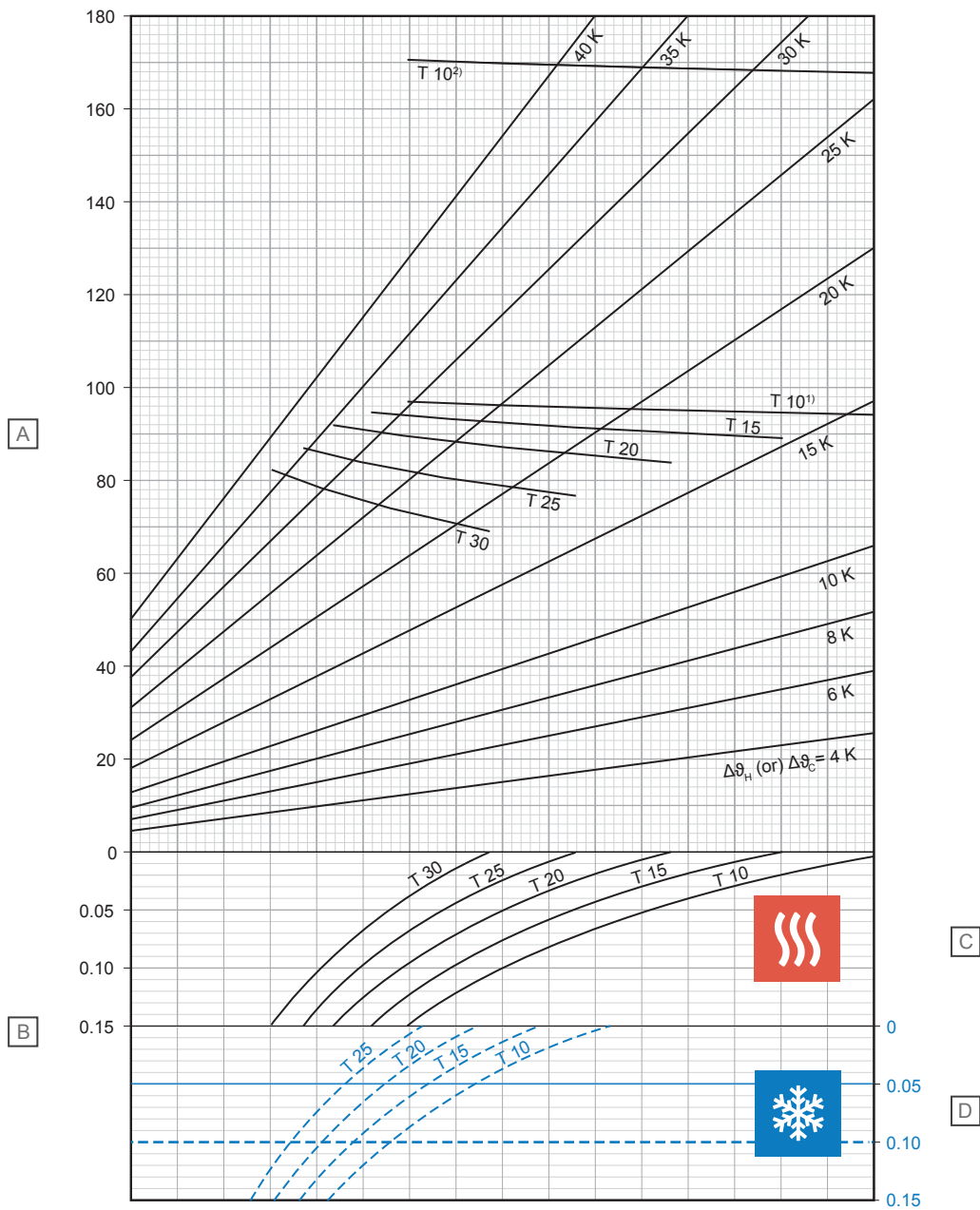

Item	Unit	Description
A	W/m ²	Specific thermal heating or cooling output [q_H or q_C]
B	m ² K/W	Thermal resistance [$R_{\lambda,B}$]

C - Heating

T (cm)	q_H (W/m ²)	$\Delta\vartheta_{H,N}$ (K)
10	94,2	14,2
15	89,3	15,7
20	84,0	17,1
25	76,9	18,2
30	69,5	19,0

D - Cooling

T (cm)	q_C (W/m ²)	$\Delta\vartheta_{C,N}$ (K)
10	36,7	8
15	32,6	8
20	29,0	8
25	25,8	8

¹⁾ Limit curve valid for ϑ_i 20 °C and $\vartheta_{F,max}$ 29 °C or ϑ_i 24 °C and $\vartheta_{F,max}$ 33 °C

²⁾ Limit curve valid for ϑ_i 20 °C and $\vartheta_{F,max}$ 35 °C

Uponor Comfort Pipe PLUS 16 x 2,0 mm with screed load distribution layer (su = 45 mm with $\lambda u = 1,2 \text{ W/mK}$)

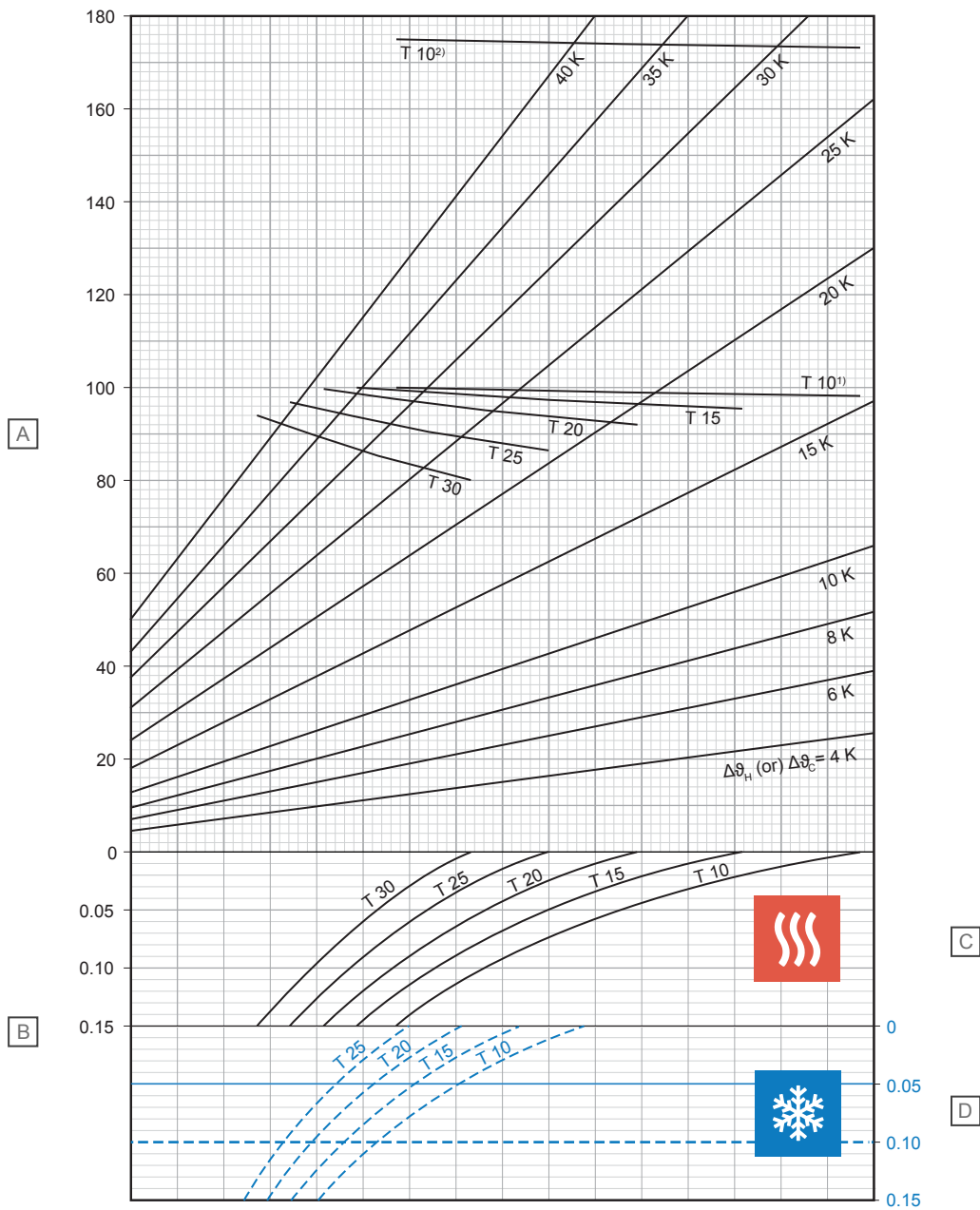

Item	Unit	Description
A	W/m ²	Specific thermal heating or cooling output [q_H or q_C]
B	m ² K/W	Thermal resistance [$R_{\lambda,B}$]

C - Heating

T (cm)	q_H (W/m ²)	$\Delta\vartheta_{H,N}$ (K)
10	98,4	15,7
15	95,7	17,7
20	92,4	19,7
25	86,9	21,4
30	80,8	22,9

D - Cooling

T (cm)	q_C (W/m ²)	$\Delta\vartheta_{C,N}$ (K)
10	35,2	8
15	31,4	8
20	28,0	8
25	25,0	8

¹⁾ Limit curve valid for ϑ_i 20 °C and $\vartheta_{F,max}$ 29 °C or ϑ_i 24 °C and $\vartheta_{F,max}$ 33 °C

²⁾ Limit curve valid for ϑ_i 20 °C and $\vartheta_{F,max}$ 35 °C

Uponor Comfort Pipe PLUS 16 x 2,0 mm with screed load distribution layer (su = 65 mm with $\lambda_u = 1,2 \text{ W/mK}$)

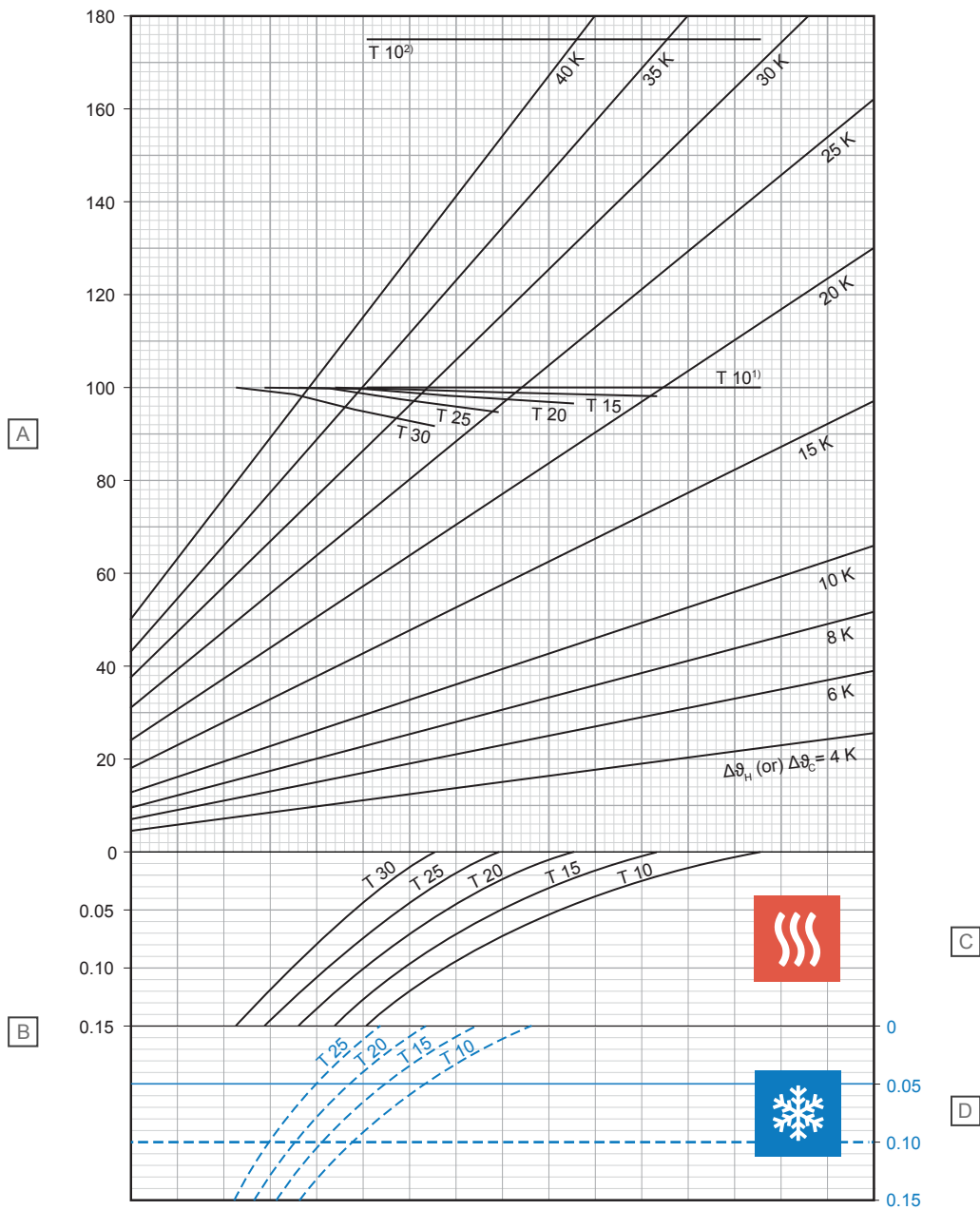

D10000248

Item	Unit	Description
A	W/m ²	Specific thermal heating or cooling output [q_H or q_C]
B	m ² K/W	Thermal resistance [$R_{\lambda,B}$]

C - Heating

T (cm)	q_H (W/m ²)	$\Delta\vartheta_{H,N}$ (K)
10	100,0	17,9
15	98,3	20,2
20	96,8	22,7
25	95,2	25,4
30	92,2	28,0

D - Cooling

T (cm)	q_C (W/m ²)	$\Delta\vartheta_{C,N}$ (K)
10	32,3	8
15	29,0	8
20	26,1	8
25	23,5	8

¹⁾ Limit curve valid for ϑ_i 20 °C and $\vartheta_{F,max}$ 29 °C or ϑ_i 24 °C and $\vartheta_{F,max}$ 33 °C

²⁾ Limit curve valid for ϑ_i 20 °C and $\vartheta_{F,max}$ 35 °C

Uponor Comfort Pipe PLUS 16 x 2,0 mm with screed load distribution layer (su = 75 mm with $\lambda u = 1,2 \text{ W/mK}$)

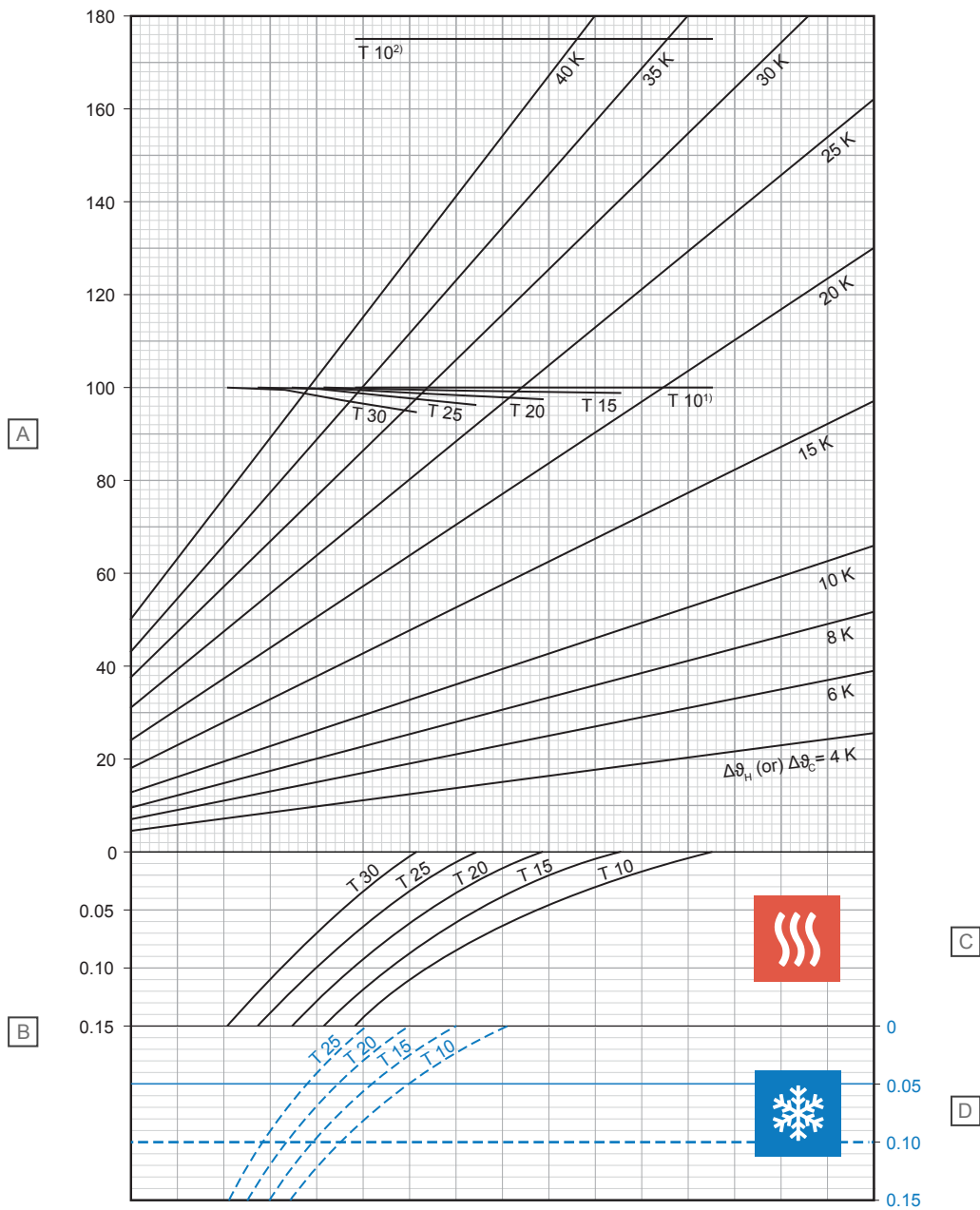

D10000249

Item	Unit	Description
A	W/m ²	Specific thermal heating or cooling output [q _H or q _C]
B	m ² K/W	Thermal resistance [R _{A,B}]

C - Heating

T (cm)	q _H (W/m ²)	Δθ _{H,N} (K)
10	100,0	19,0
15	99,0	21,4
20	97,7	24,0
25	96,6	26,9
30	95,1	30,0

D - Cooling

T (cm)	q _C (W/m ²)	Δθ _{C,N} (K)
10	30,9	8
15	27,9	8
20	25,2	8
25	22,8	8

¹) Limit curve valid for ϑ_i 20 °C and $\vartheta_{F, \max}$ 29 °C or ϑ_i 24 °C and $\vartheta_{F, \max}$ 33 °C

²) Limit curve valid for ϑ_i 20 °C and $\vartheta_{F, \max}$ 35 °C

Uponor Comfort Pipe PLUS 17 x 2,0 mm with screed load distribution layer (su = 35 mm with $\lambda_u = 1,2 \text{ W/mK}$)

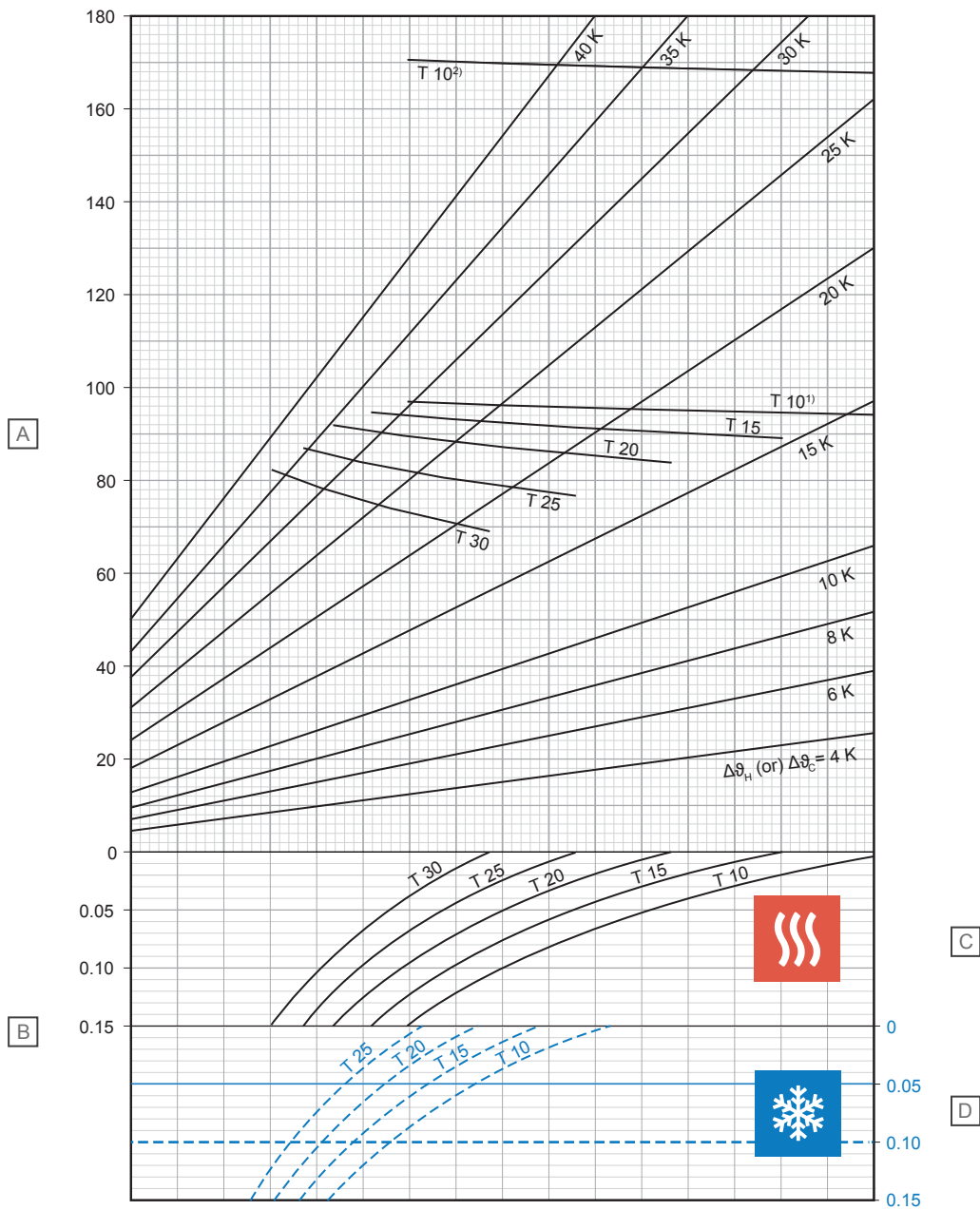

Item	Unit	Description
A	W/m^2	Specific thermal heating or cooling output [q_H or q_C]
B	$\text{m}^2\text{K/W}$	Thermal resistance [$R_{\lambda,B}$]

C - Heating

T (cm)	q_H (W/m^2)	$\Delta\theta_{H,N}$ (K)
10	94,1	14,1
15	89,1	15,5
20	83,8	16,9
25	76,6	17,9
30	69,1	18,7

D - Cooling

T (cm)	q_C (W/m^2)	$\Delta\theta_{C,N}$ (K)
10	36,9	8
15	32,8	8
20	29,3	8
25	26,1	8

¹⁾ Limit curve valid for $\vartheta_i 20^\circ\text{C}$ and $\vartheta_{F,max} 29^\circ\text{C}$ or $\vartheta_i 24^\circ\text{C}$ and $\vartheta_{F,max} 33^\circ\text{C}$

²⁾ Limit curve valid for $\vartheta_i 20^\circ\text{C}$ and $\vartheta_{F,max} 35^\circ\text{C}$

Uponor Comfort Pipe PLUS 17 x 2,0 mm with screed load distribution layer (su = 45 mm with $\lambda_u = 1,2 \text{ W/mK}$)

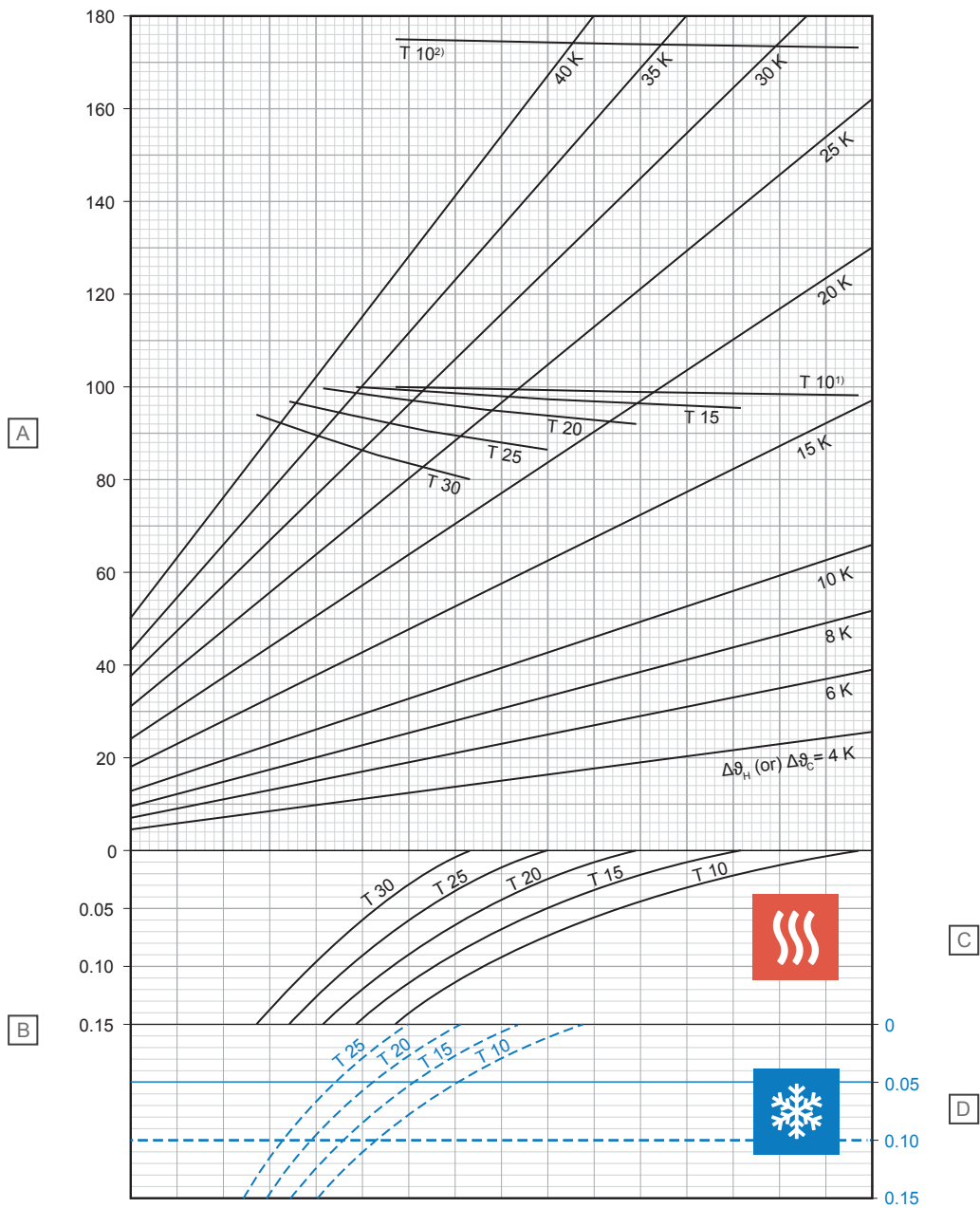

Item	Unit	Description
A	W/m ²	Specific thermal heating or cooling output [q_H or q_C]
B	m ² K/W	Thermal resistance [$R_{\lambda,B}$]

C - Heating

T (cm)	q_H (W/m ²)	$\Delta\vartheta_{H,N}$ (K)
10	98,3	15,5
15	95,6	17,5
20	92,2	19,4
25	86,6	21,0
30	80,4	22,4

D - Cooling

T (cm)	q_C (W/m ²)	$\Delta\vartheta_{C,N}$ (K)
10	35,4	8
15	31,6	8
20	28,3	8
25	25,3	8

¹⁾ Limit curve valid for ϑ_i 20 °C and $\vartheta_{F,max}$ 29 °C or ϑ_i 24 °C and $\vartheta_{F,max}$ 33 °C

²⁾ Limit curve valid for ϑ_i 20 °C and $\vartheta_{F,max}$ 35 °C

Uponor Comfort Pipe PLUS 17 x 2,0 mm with screed load distribution layer (su = 65 mm with $\lambda u = 1,2 \text{ W/mK}$)

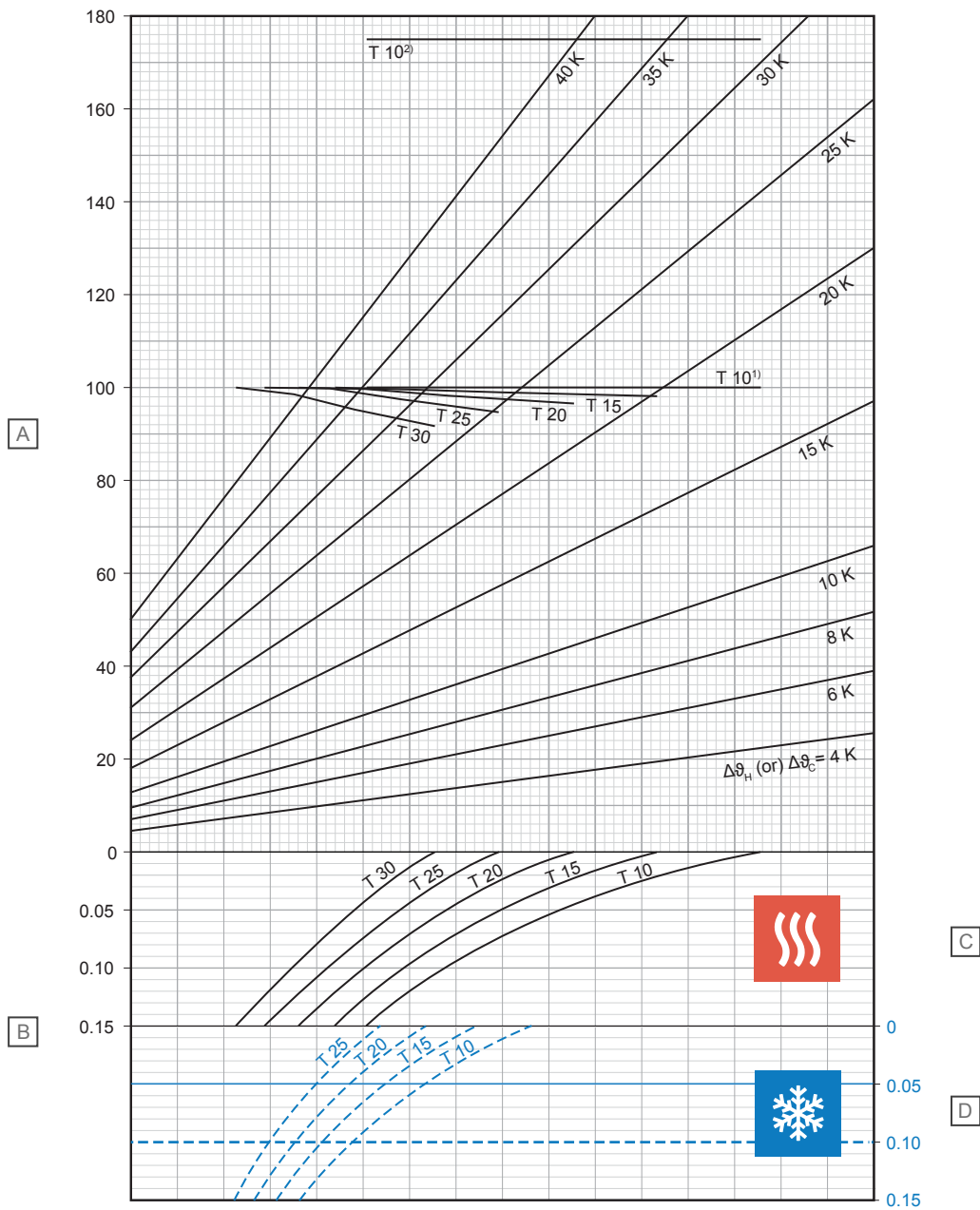

Item	Unit	Description
A	W/m ²	Specific thermal heating or cooling output [q _H or q _C]
B	m ² K/W	Thermal resistance [R _{A,B}]

C - Heating

T (cm)	q _H (W/m ²)	Δθ _{H,N} (K)
10	100,0	17,8
15	98,3	20,0
20	96,8	22,4
25	95,0	25,0
30	91,9	27,6

D - Cooling

T (cm)	q _C (W/m ²)	Δθ _{C,N} (K)
10	32,5	8
15	29,3	8
20	26,4	8
25	23,8	8

¹⁾ Limit curve valid for ϑ_i 20 °C and $\vartheta_{F, \max}$ 29 °C or ϑ_i 24 °C and $\vartheta_{F, \max}$ 33 °C

²⁾ Limit curve valid for ϑ_i 20 °C and $\vartheta_{F, \max}$ 35 °C

Uponor MLCP RED 14 x 1,6 mm with screed load distribution layer (su = 35 mm with $\lambda_u = 1,2 \text{ W/mK}$)

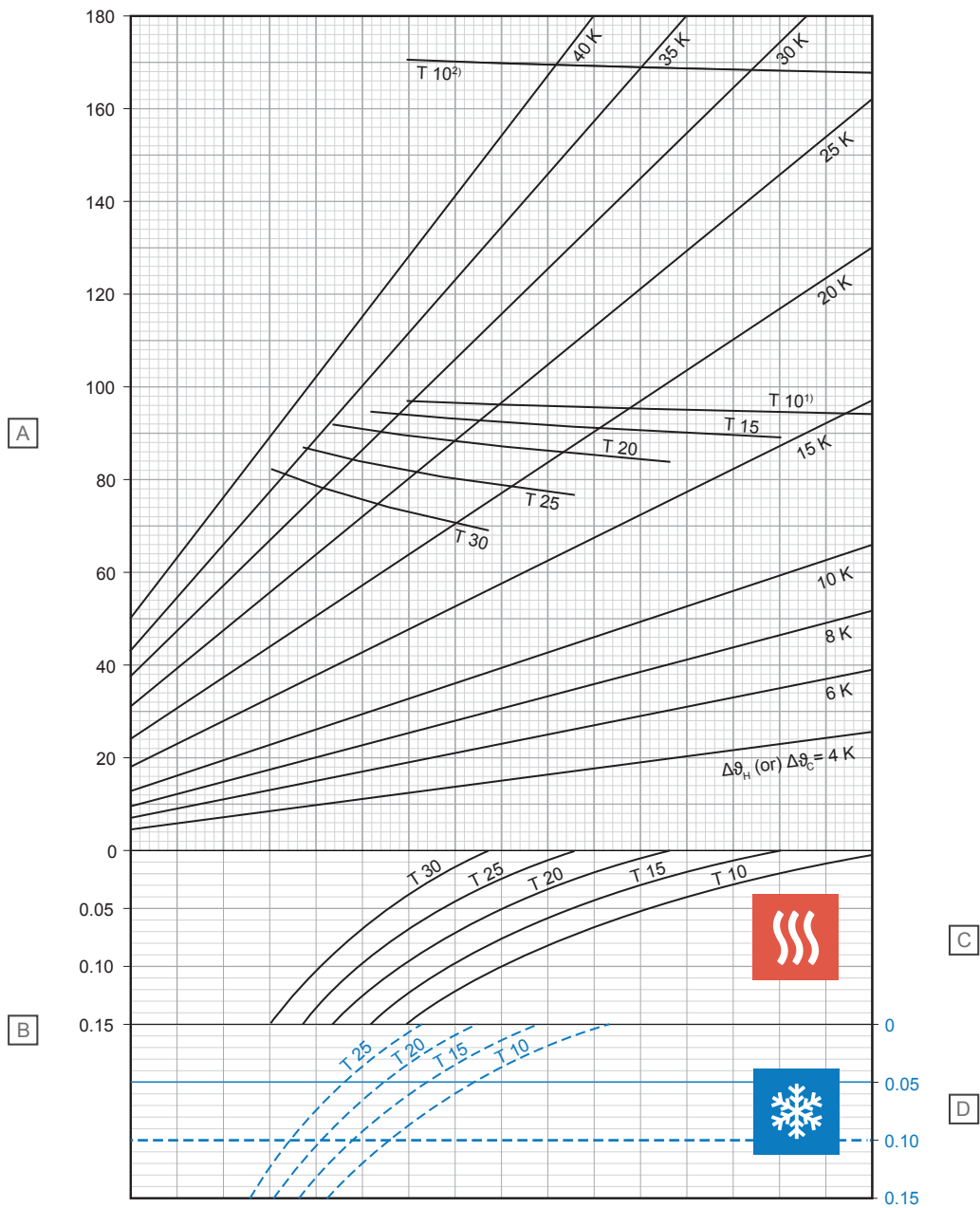

Item	Unit	Description
A	W/m ²	Specific thermal heating or cooling output [q_H or q_C]
B	m ² K/W	Thermal resistance [$R_{\lambda,B}$]

C - Heating

T (cm)	q_H (W/m ²)	$\Delta\vartheta_{H,N}$ (K)
10	94,2	13,9
15	89,2	15,3
20	83,8	16,6
25	76,6	17,5
30	68,9	18,3

D - Cooling

T (cm)	q_C (W/m ²)	$\Delta\vartheta_{C,N}$ (K)
10	37,1	8
15	33,1	8
20	29,6	8
25	26,4	8

¹⁾ Limit curve valid for ϑ_i 20 °C and $\vartheta_{F,max}$ 29 °C or ϑ_i 24 °C and $\vartheta_{F,max}$ 33 °C

²⁾ Limit curve valid for ϑ_i 20 °C and $\vartheta_{F,max}$ 35 °C

Uponor MLCP RED 14 x 1,6 mm with screed load distribution layer (su = 45 mm with $\lambda_u = 1,2 \text{ W/mK}$)

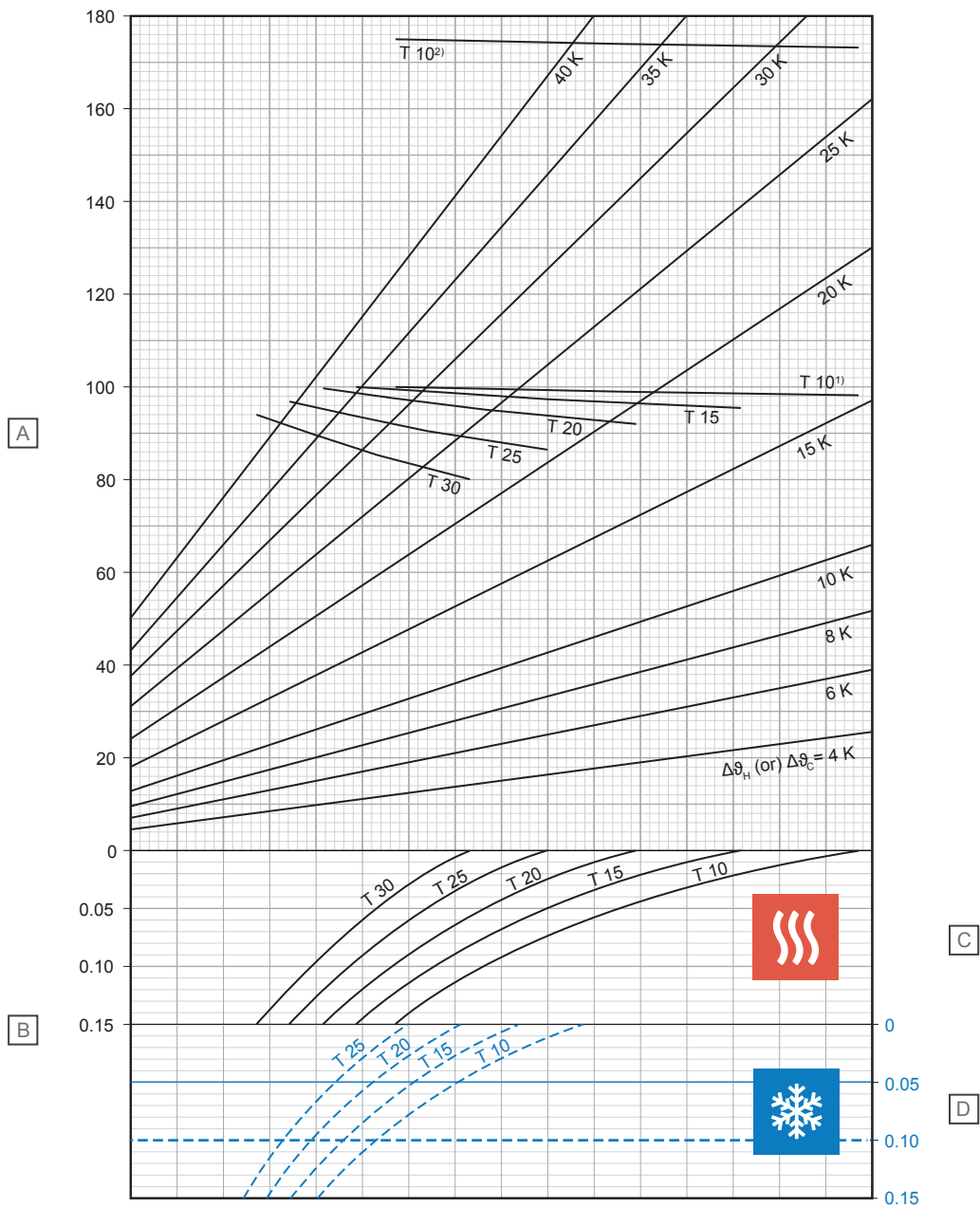

D10000251

Item	Unit	Description
A	W/m ²	Specific thermal heating or cooling output [q_H or q_C]
B	m ² K/W	Thermal resistance [$R_{\lambda,B}$]

C - Heating

T (cm)	q_H (W/m ²)	$\Delta\vartheta_{H,N}$ (K)
10	98,3	15,4
15	95,6	17,2
20	92,1	19,1
25	86,4	20,6
30	80,1	22,0

D - Cooling

T (cm)	q_C (W/m ²)	$\Delta\vartheta_{C,N}$ (K)
10	35,6	8
15	31,9	8
20	28,6	8
25	25,6	8

¹⁾ Limit curve valid for ϑ_i 20 °C and $\vartheta_{F,max}$ 29 °C or ϑ_i 24 °C and $\vartheta_{F,max}$ 33 °C

²⁾ Limit curve valid for ϑ_i 20 °C and $\vartheta_{F,max}$ 35 °C

Uponor MLCP RED 14 x 1,6 mm with screed load distribution layer (su = 65 mm with $\lambda_u = 1,2 \text{ W/mK}$)

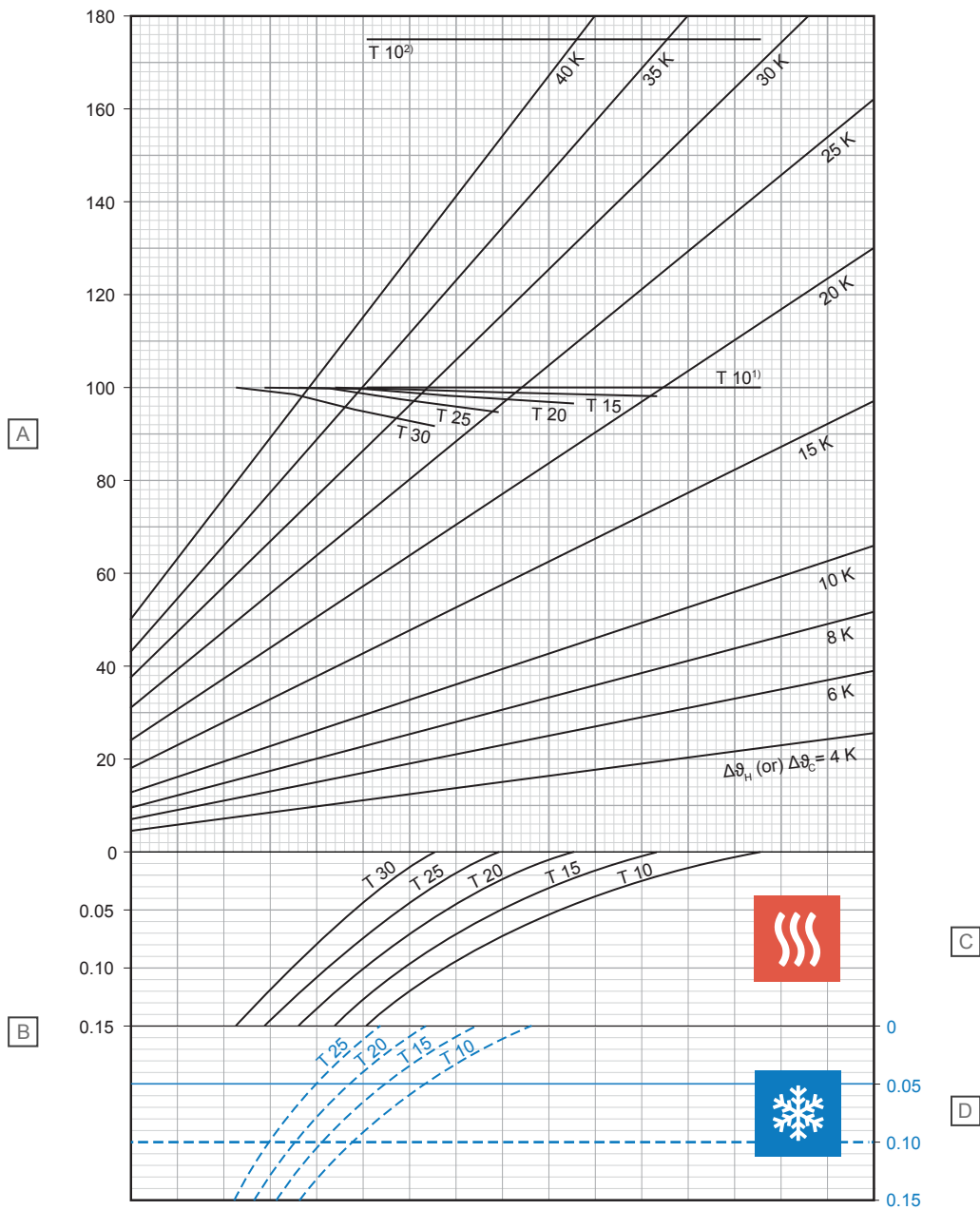

Item	Unit	Description
A	W/m^2	Specific thermal heating or cooling output [q_H or q_C]
B	$\text{m}^2\text{K/W}$	Thermal resistance [$R_{\lambda,B}$]

C - Heating

T (cm)	$q_H \text{ (W/m}^2\text{)}$	$\Delta\theta_{H,N} \text{ (K)}$
10	100,0	17,6
15	98,3	19,8
20	96,7	22,1
25	94,9	24,7
30	91,7	27,1

D - Cooling

T (cm)	$q_C \text{ (W/m}^2\text{)}$	$\Delta\theta_{C,N} \text{ (K)}$
10	32,7	8
15	29,4	8
20	26,6	8
25	24,0	8

¹⁾ Limit curve valid for $\vartheta_i 20 \text{ }^\circ\text{C}$ and $\vartheta_{F, \text{max}} 29 \text{ }^\circ\text{C}$ or $\vartheta_i 24 \text{ }^\circ\text{C}$ and $\vartheta_{F, \text{max}} 33 \text{ }^\circ\text{C}$

²⁾ Limit curve valid for $\vartheta_i 20 \text{ }^\circ\text{C}$ and $\vartheta_{F, \text{max}} 35 \text{ }^\circ\text{C}$

Uponor MLCP RED 14 x 1,6 mm with screed load distribution layer (su = 75 mm with $\lambda_u = 1,2 \text{ W/mK}$)

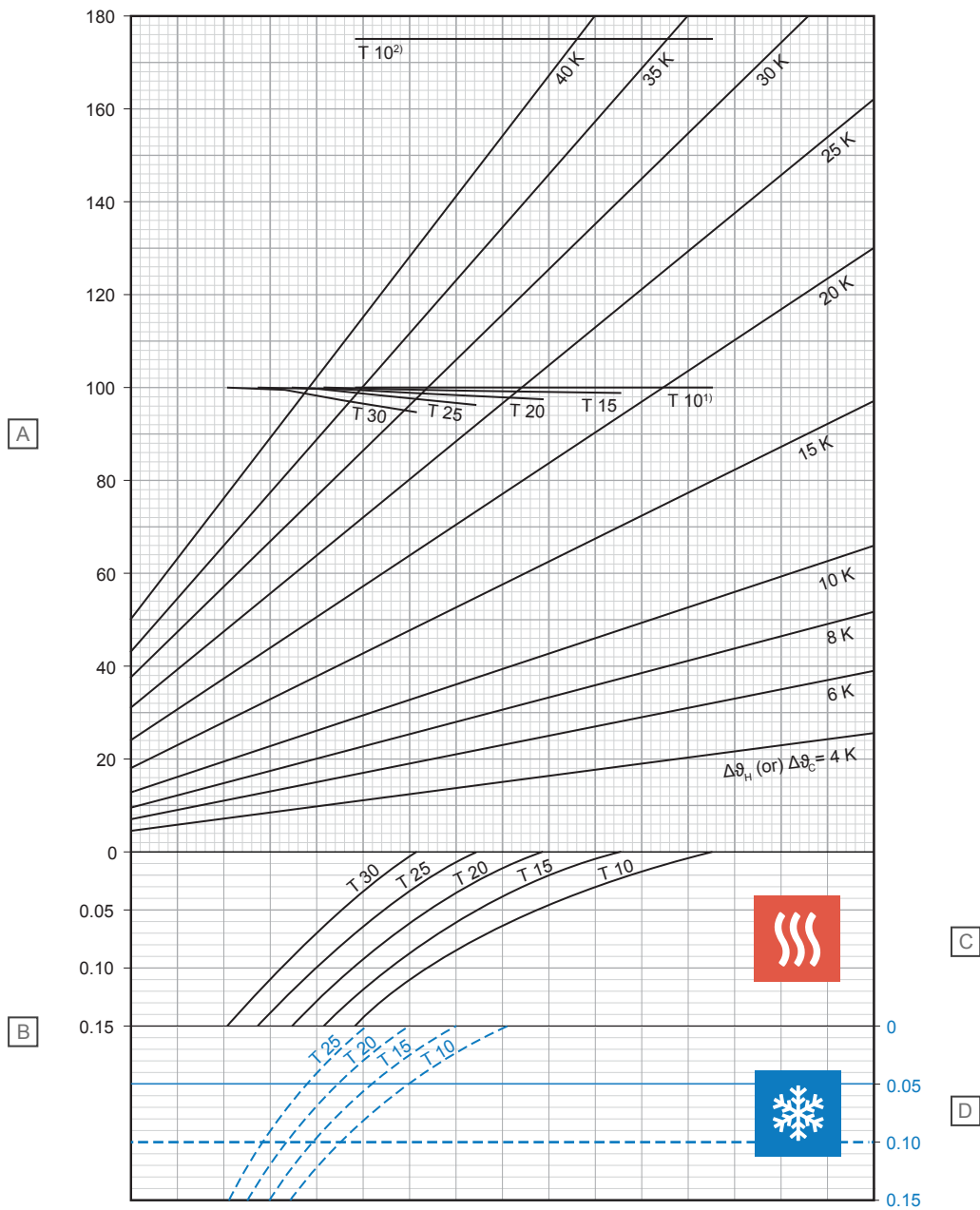

Item	Unit	Description
A	W/m ²	Specific thermal heating or cooling output [q _H or q _C]
B	m ² K/W	Thermal resistance [R _{A,B}]

C - Heating

T (cm)	q _H (W/m ²)	Δθ _{H,N} (K)
10	100,0	18,7
15	99,0	21,0
20	97,6	23,5
25	96,4	26,2
30	94,8	29,1

D - Cooling

T (cm)	q _C (W/m ²)	Δθ _{C,N} (K)
10	31,2	8
15	28,3	8
20	25,6	8
25	23,2	8

¹) Limit curve valid for ϑ_i 20 °C and $\vartheta_{F, \max}$ 29 °C or ϑ_i 24 °C and $\vartheta_{F, \max}$ 33 °C

²) Limit curve valid for ϑ_i 20 °C and $\vartheta_{F, \max}$ 35 °C

Uponor MLCP RED 16 x 2,0 mm with screed load distribution layer (su = 35 mm with $\lambda_u = 1,2 \text{ W/mK}$)

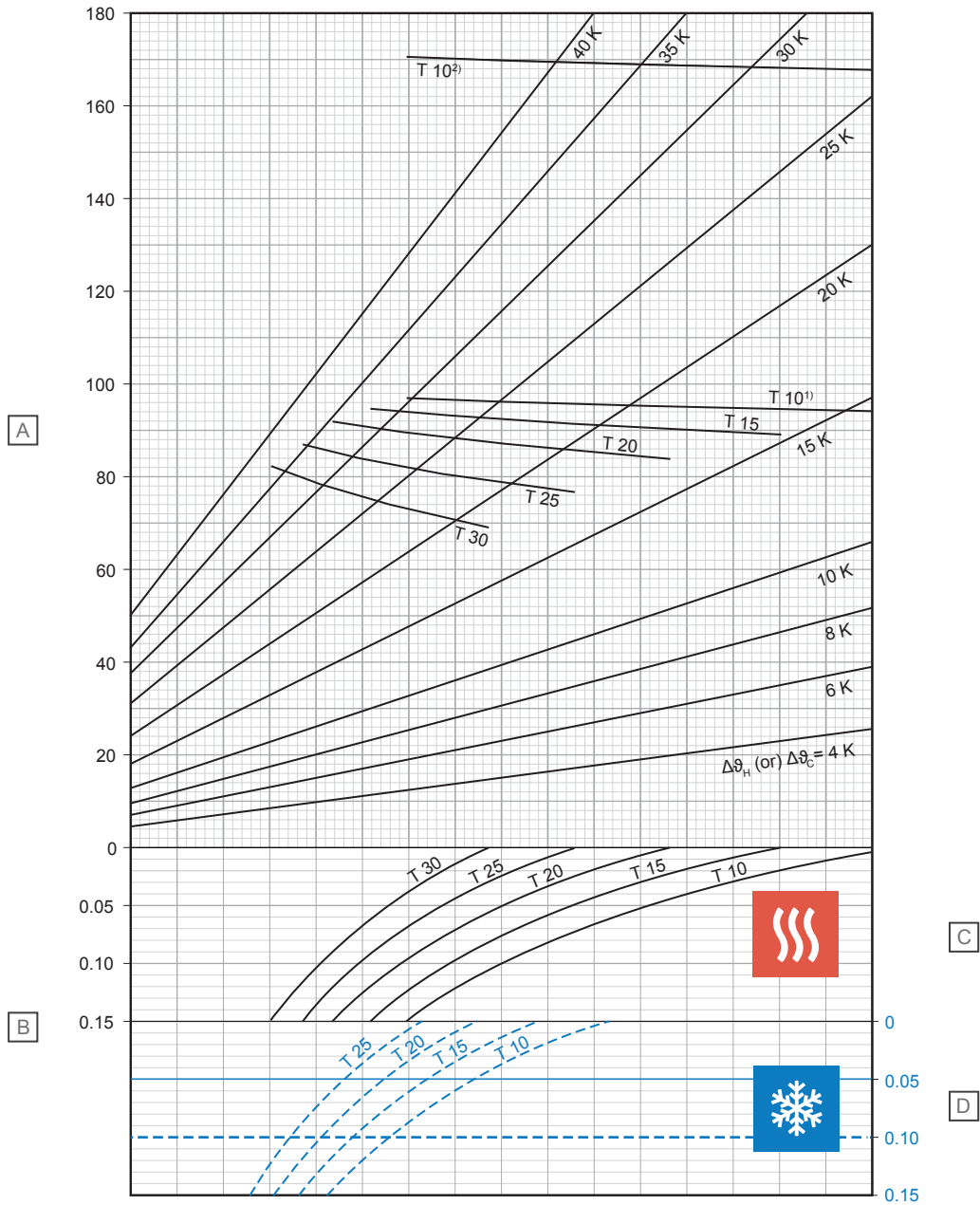

Item	Unit	Description
A	W/m ²	Specific thermal heating or cooling output [q_H or q_C]
B	m ² K/W	Thermal resistance [$R_{\lambda,B}$]

C - Heating

T (cm)	q_H (W/m ²)	$\Delta\vartheta_{H,N}$ (K)
10	94,2	14,0
15	89,2	15,4
20	83,8	16,8
25	76,6	17,8
30	69,0	18,5

D - Cooling

T (cm)	q_C (W/m ²)	$\Delta\vartheta_{C,N}$ (K)
10	37,0	8
15	32,9	8
20	29,4	8
25	26,2	8

¹⁾ Limit curve valid for ϑ_i 20 °C and $\vartheta_{F,max}$ 29 °C or ϑ_i 24 °C and $\vartheta_{F,max}$ 33 °C

²⁾ Limit curve valid for ϑ_i 20 °C and $\vartheta_{F,max}$ 35 °C

Uponor MLCP RED 16 x 2,0 mm with screed load distribution layer (su = 45 mm with $\lambda_u = 1,2 \text{ W/mK}$)

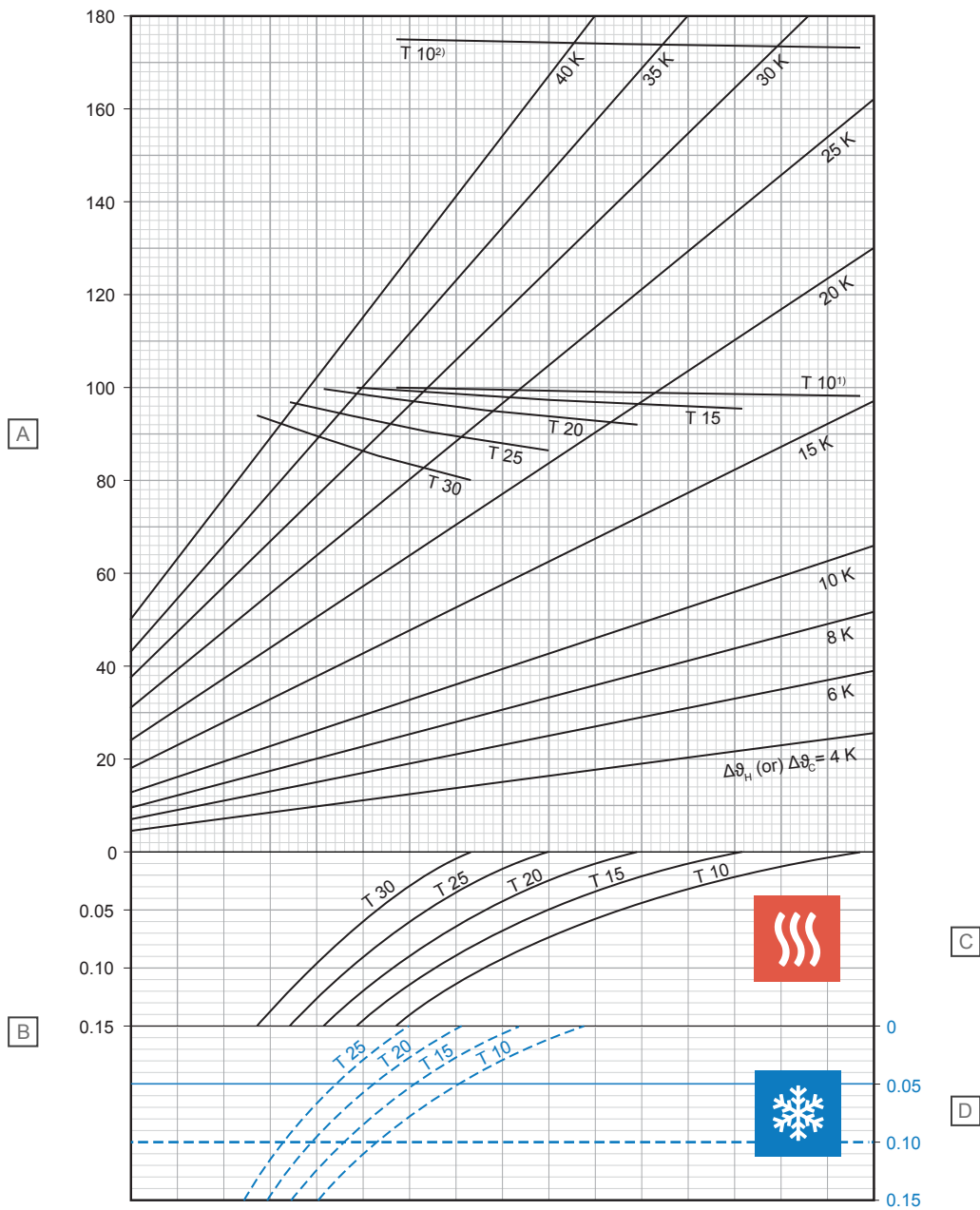

D10000255

Item	Unit	Description
A	W/m ²	Specific thermal heating or cooling output [q _H or q _C]
B	m ² K/W	Thermal resistance [R _{A,B}]

C - Heating

T (cm)	q _H (W/m ²)	Δθ _{H,N} (K)
10	98,3	15,5
15	95,6	17,4
20	92,2	19,3
25	86,6	20,9
30	80,3	22,3

D - Cooling

T (cm)	q _C (W/m ²)	Δθ _{C,N} (K)
10	35,5	8
15	31,7	8
20	28,4	8
25	25,4	8

¹⁾ Limit curve valid for θ_i 20 °C and θ_{F, max} 29 °C or θ_i 24 °C and θ_{F, max} 33 °C

²⁾ Limit curve valid for θ_i 20 °C and θ_{F, max} 35 °C

Uponor MLCP RED 16 x 2,0 mm with screed load distribution layer (su = 65 mm with $\lambda_u = 1,2 \text{ W/mK}$)

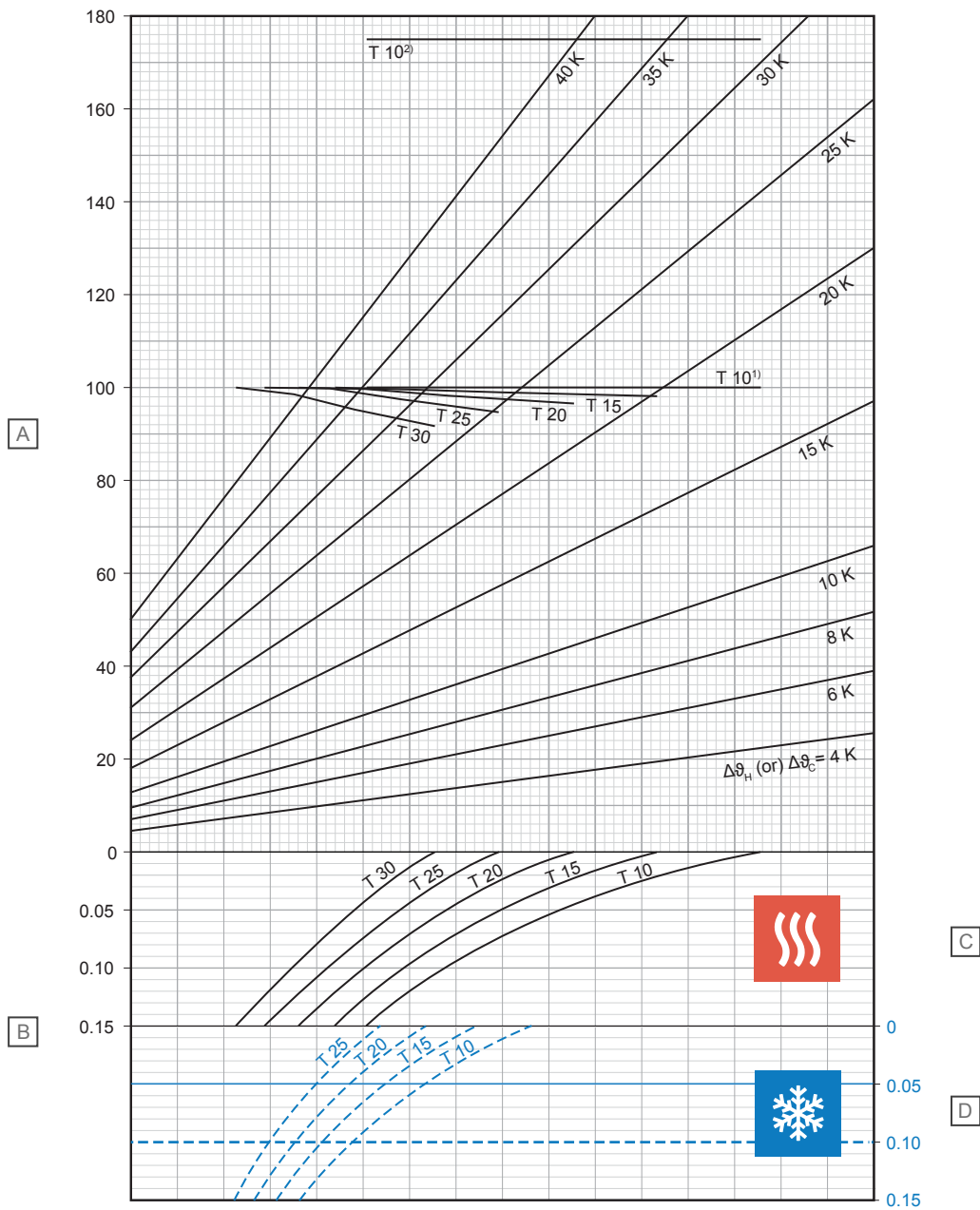

D10000256

Item	Unit	Description
A	W/m^2	Specific thermal heating or cooling output [q_H or q_C]
B	$\text{m}^2\text{K/W}$	Thermal resistance [$R_{\lambda,B}$]

C - Heating

T (cm)	q_H (W/m^2)	$\Delta\theta_{H,N}$ (K)
10	100,0	17,7
15	98,3	19,9
20	96,7	22,3
25	95,0	24,9
30	91,9	27,4

D - Cooling

T (cm)	q_C (W/m^2)	$\Delta\theta_{C,N}$ (K)
10	32,6	8
15	29,3	8
20	26,4	8
25	23,8	8

¹⁾ Limit curve valid for ϑ_i 20 °C and $\vartheta_{F,max}$ 29 °C or ϑ_i 24 °C and $\vartheta_{F,max}$ 33 °C

²⁾ Limit curve valid for ϑ_i 20 °C and $\vartheta_{F,max}$ 35 °C

Uponor MLCP RED 16 x 2,0 mm with screed load distribution layer (su = 75 mm with $\lambda_u = 1,2 \text{ W/mK}$)

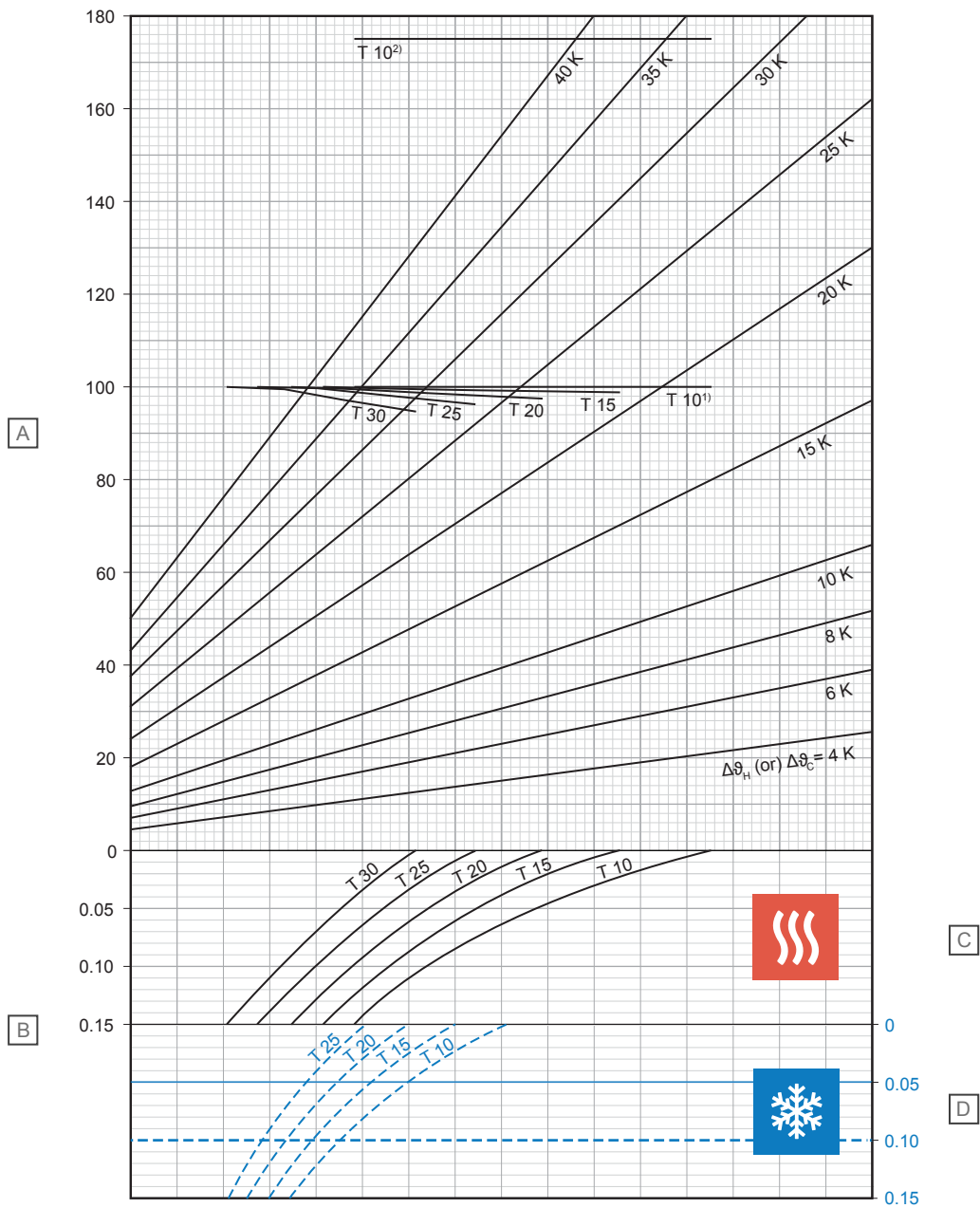

D10000257

Item	Unit	Description
A	W/m ²	Specific thermal heating or cooling output [q_H or q_C]
B	m ² K/W	Thermal resistance [$R_{\lambda,B}$]

C - Heating

T (cm)	q_H (W/m ²)	$\Delta\vartheta_{H,N}$ (K)
10	100,0	18,8
15	99,0	21,1
20	97,7	23,6
25	96,5	26,4
30	94,9	29,4

D - Cooling

T (cm)	q_C (W/m ²)	$\Delta\vartheta_{C,N}$ (K)
10	31,2	8
15	28,2	8
20	25,5	8
25	23,1	8

¹⁾ Limit curve valid for ϑ_i 20 °C and $\vartheta_{F,max}$ 29 °C or ϑ_i 24 °C and $\vartheta_{F,max}$ 33 °C

²⁾ Limit curve valid for ϑ_i 20 °C and $\vartheta_{F,max}$ 35 °C

2.3 Pressure drop diagrams

Uponor Comfort Pipe PLUS

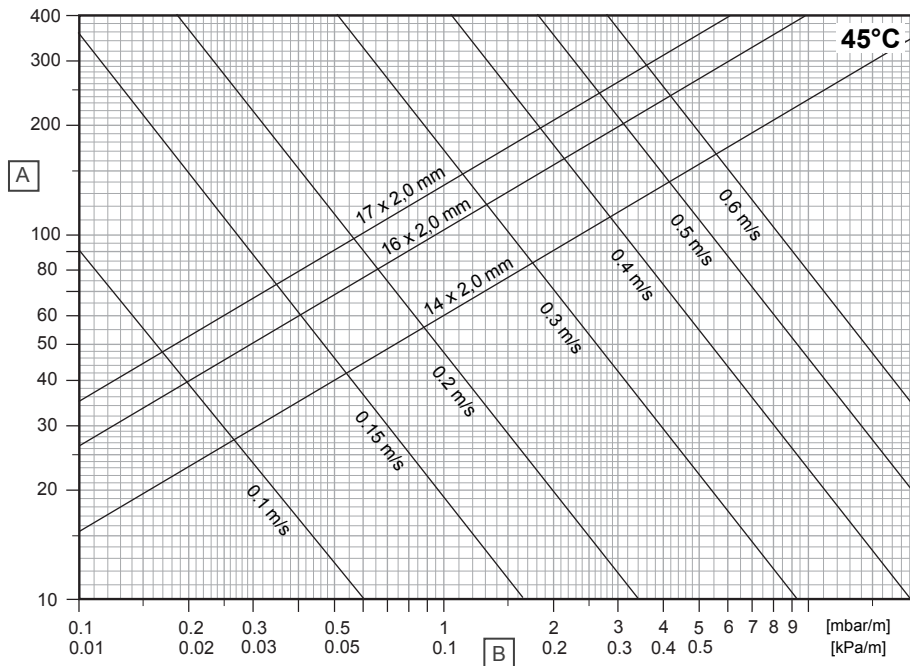

D10000245

Item	Unit	Description
A	kg/h	Mass flow rate
B	R	Pressure gradient

Uponor MLCP RED

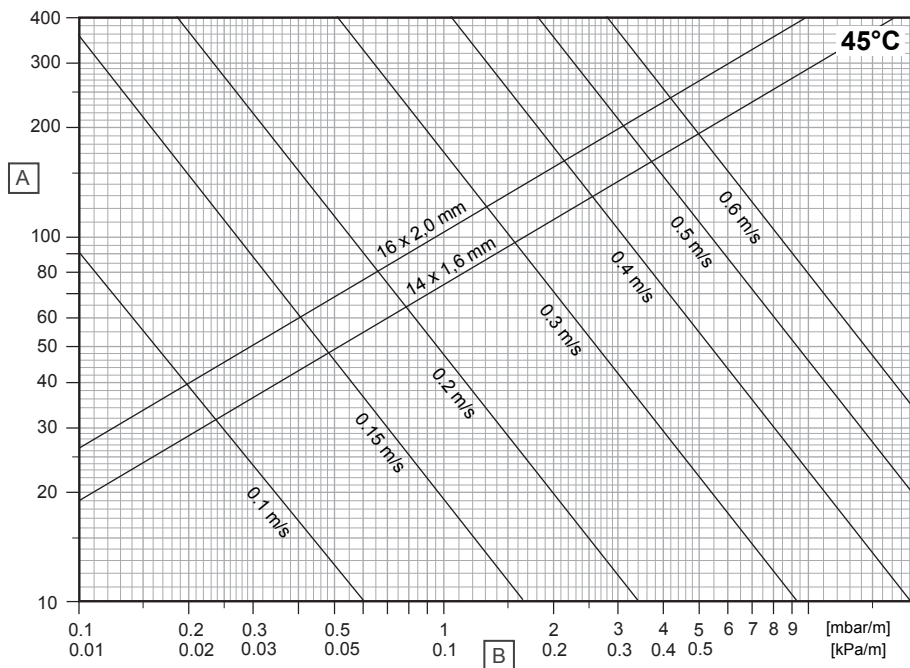

D10000286

Item	Unit	Description
A	kg/h	Mass flow rate
B	R	Pressure gradient

3 Installation

3.1 Installation process



Note

Installation must be performed by a qualified person in accordance with local standards and regulations.

As a guidance, always read and follow the instructions given in respective Uponor installation manual.

1. Edging strip installation

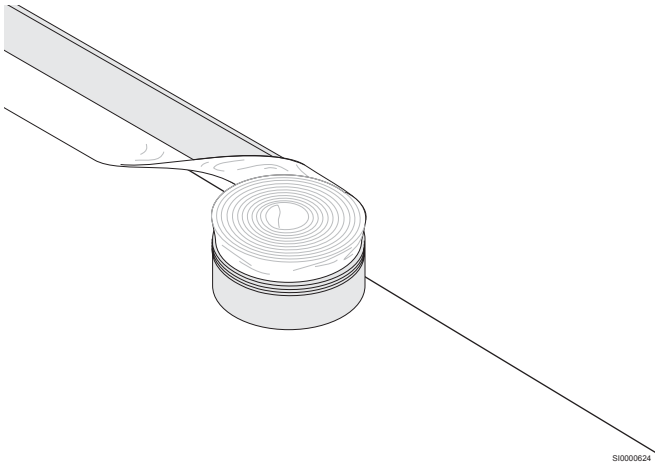

2. Panel installation

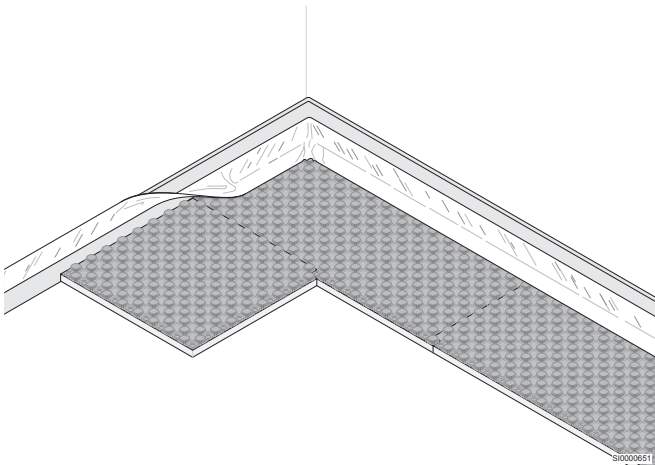

3. Pipe installation

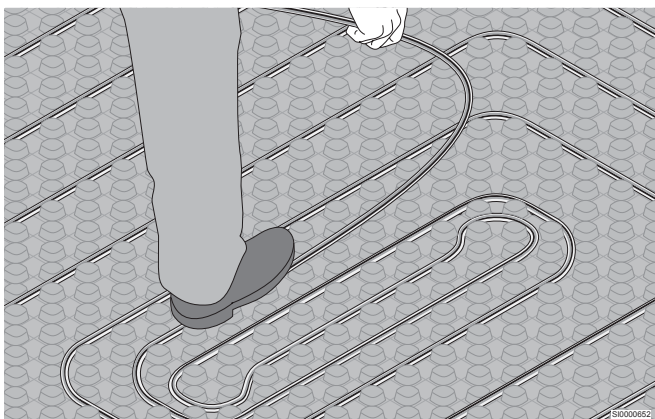

4. Connecting pipes to the manifold

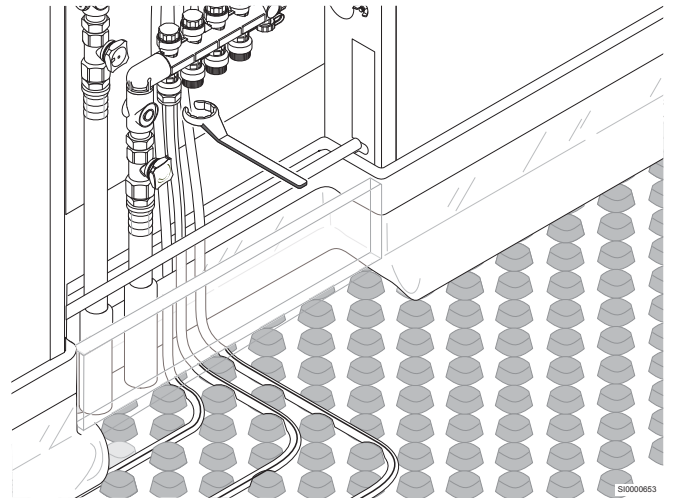

4 Technical data

4.1 Technical specifications

Uponor Tecto nub panel

Description	Value	Value
Product name	ND 30-2	ND 11
Material	EPS, PS	EPS, PS
Max. live load	5,0 kN/m ²	30,0 kN/m ²
Thermal resistance	0,75 m ² K/W	0,275 m ² K/W
Dynamic stiffness	20 MN/m ³	-
Compressive stress	≥ 100 kPa	-
Pipe spacing	10, 15, 20, 25, 30 cm	10, 15, 20, 25, 30 cm
Total height	52 mm	33 mm
Type of system	Wet system	Wet system
Load distribution layer	Cement screed or anhydrite screed	Cement screed or anhydrite screed
Screed volume between nubs	approx. 18.5 l/m ²	approx. 18.5 l/m ²

Uponor Comfort Pipe PLUS

	Value	Value	Value
Pipe designation	Uponor Comfort Pipe PLUS 14 x 2,0 mm	Uponor Comfort Pipe PLUS 16 x 2,0 mm	Uponor Comfort Pipe PLUS 17 x 2,0 mm
Pipe dimension	14 x 2,0 mm	16 x 2,0 mm	17 x 2,0 mm
Pipe length	120; 240; 640; 960 m	120; 240; 640 m	60; 120; 240; 480; 640 m
Material	PE-Xa, five-layer pipe	PE-Xa, five-layer pipe	PE-Xa, five-layer pipe
Colour	White with two blue longitudinal stripes	White with two blue longitudinal stripes	White with two blue longitudinal stripes
Manufacturing	Refer to EN ISO 15875	Refer to EN ISO 15875	Refer to EN ISO 15875
Certificates	KOMO, DIN CERTCO	KOMO, DIN CERTCO	KOMO, DIN CERTCO
Area of application	Class 4 + 5 / 6 bar (EN ISO 15875)	Class 4 + 5 / 6 bar (EN ISO 15875)	Class 4 + 5 / 6 bar (EN ISO 15875)
Max. operating temperature ¹⁾	90 °C (EN ISO 15875)	90 °C (EN ISO 15875)	90 °C (EN ISO 15875)
Max. operating pressure	6 bar at 70° C	6 bar at 70° C	6 bar at 70° C
Pipe jointings	Uponor screw connection Uponor Smart press coupling	Uponor screw connection, Uponor Smart press coupling, Uponor Q&E technology	Uponor screw connection, Uponor Q&E technology
Weight	0,078 kg/m	0,091 kg/m	0,098 kg/m
Water content	0,077 l/m	0,11 l/m	0,13 l/m
Oxygen tightness	Refer to ISO 17455; DIN 4726	Refer to ISO 17455; DIN 4726	Refer to ISO 17455; DIN 4726
Density	0,934 g/cm ³	0,934 g/cm ³	0,934 g/cm ³
Material class	Class B2 and class E, DIN 4102 / EN 13501	Class B2 and class E, DIN 4102 / EN 13501	Class B2 and class E, DIN 4102 / EN 13501
Min. bending radius	8 x D; free-hand bending (112 mm) 5 x D; supported bending (70 mm)	8 x D; free-hand bending (128 mm) 5 x D; supported bending (80 mm)	8 x D; free-hand bending (136 mm) 5 x D; supported bending (85 mm)
Pipe roughness	0,007 mm	0,007 mm	0,007 mm
Ideal installation temperature	≥ 0 °C	≥ 0 °C	≥ 0 °C
UV protection	Opaque cardboard (store remaining quantities in the cardboard box)	Opaque cardboard (store remaining quantities in the cardboard box)	Opaque cardboard (store remaining quantities in the cardboard box)

1) When more than one design temperature appears for any class, the times should be aggregated (e.g. the design temperature profile

for 50 years class 5 is: 20 °C for 14 years followed by 60 °C for 25 years, 80 °C for 10 years, 90 °C for 1 year and 100 °C for 100h).

Uponor MLCP RED

Description	Value	Value
Pipe designation	Uponor MLCP RED 14 x 1,6 mm	Uponor MLCP RED 16 x 2,0 mm
Pipe dimension	14 x 1,6 mm	16 x 2,0 mm
Pipe length	240; 480 m	240; 480 m
Material	Multi-layer composite pipe (PE-RT - aluminium - PE-RT), monitored by SKZ (Southern German Plastics Centre), oxygen-tight refer to DIN 4726.	Multi-layer composite pipe (PE-RT - aluminium - PE-RT), monitored by SKZ (Southern German Plastics Centre), oxygen-tight refer to DIN 4726.
Colour	Red	Red
Manufacturing	Refer to EN ISO 21003	Refer to EN ISO 21003
Certificates	KOMO, DIN CERTCO	KOMO, DIN CERTCO
Area of application	Class 4 / 5 (ISO 10508)	Class 4 / 5 (ISO 10508)
Max. operating temperature	60 °C	60 °C
Max. operating pressure	4 bar	4 bar
Pipe jointings	Uponor screw connection	Uponor screw connection Uponor S-Press PLUS
Weight	0,076 kg/m	0,117 kg/m
Water volume	0,091 l/m	0,113 l/m
Oxygen tightness	Refer to ISO 17455; DIN 4726	Refer to ISO 17455; DIN 4726
Building material class	Class B2, refer to DIN 4102	Class B2, refer to DIN 4102
Min. bending radius	4xd if free bending (56 mm) 3xd if supported bend (42 mm)	4xd if free bending (64 mm) 3xd if supported bend (48 mm)
Pipe roughness	0,004 mm	0,004 mm
Best mounting temperature	≥ 0 °C	≥ 0 °C
UV protection	Brown cardboard (store remaining quantities in the cardboard box)	Brown cardboard (store remaining quantities in the cardboard box)

Uponor

Uponor GmbH

Industriestraße 56,
D-97437 Hassfurt, Germany

1141644 v2_06_2024_EN
Production: Uponor/SKA

Uponor reserves the right to make changes, without prior notification, to the specification of incorporated components in line with its policy of continuous improvement and development.



www.uponor.com