

Uponor Base controller H pump X-60 6x 230V

EN Operation manual

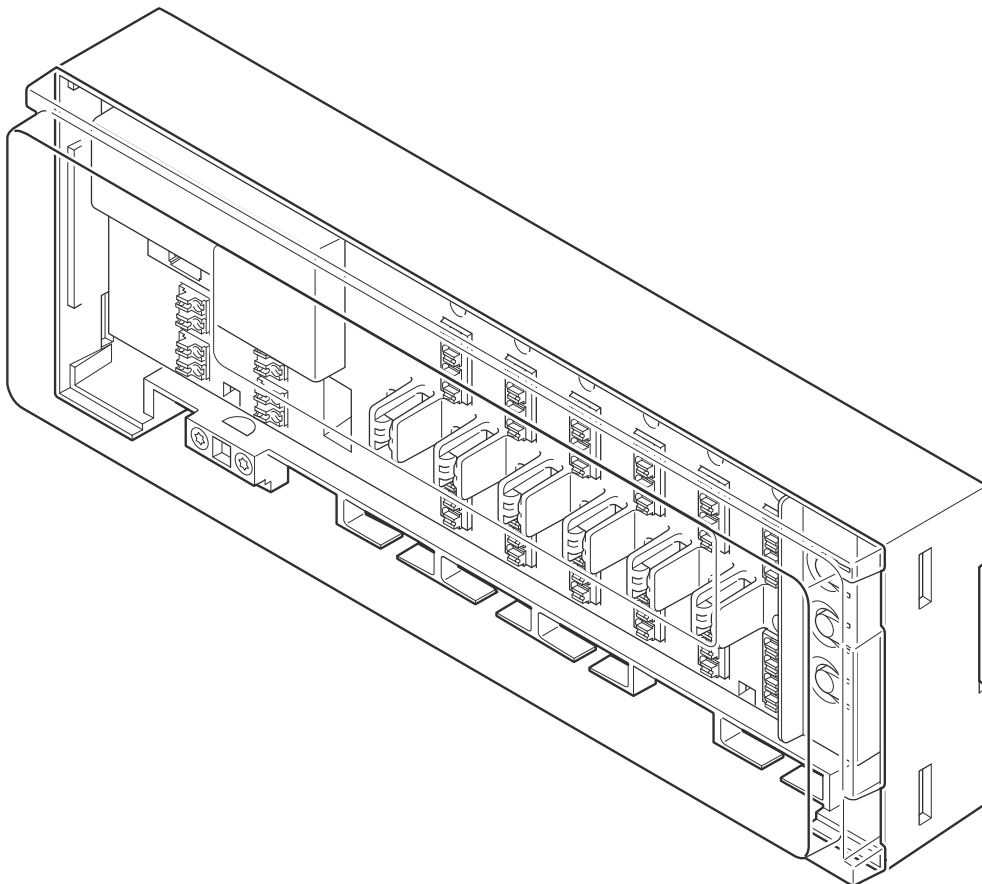





Table of contents

1	Safety instructions and disclaimer.....	3	8	Technical data.....	20
1.1	Safety instructions.....	3	8.1	Technical specifications.....	20
1.2	Correct disposal of this product (Waste Electrical and Electronic Equipment).....	3	8.2	Dimensions.....	21
1.3	Copyright and disclaimer.....	3	8.3	Wiring diagram.....	21
2	System description.....	5			
2.1	Autobalancing for more comfort and efficiency.....	5			
2.2	System compatibility.....	5			
2.3	Controller features.....	5			
2.4	Components of the controller.....	6			
3	Operation.....	9			
3.1	Controller cover opening.....	9			
3.2	Controller operation principle.....	9			
3.3	Start the controller.....	10			
3.4	Operating modes.....	10			
4	Run mode.....	11			
4.1	Example of a controller in run mode.....	11			
4.2	Features.....	11			
4.3	Autobalancing.....	11			
4.4	ON/OFF outputs management.....	11			
4.5	Pump management.....	11			
4.6	Valve exercise.....	11			
4.7	Day/night switch.....	12			
4.8	Factory reset.....	12			
5	Assignment mode.....	13			
5.1	Change from run mode to assignment mode.....	13			
5.2	Set up the assignment mode.....	13			
5.3	Enter the assignment mode with assigned thermostats/ actuators.....	13			
5.4	Assign the thermostats and actuators.....	13			
5.5	Check assigned channels.....	15			
5.6	Remove assigned channels.....	16			
5.7	Change back to run mode.....	16			
6	Maintenance.....	17			
6.1	Manual preventive maintenance.....	17			
6.2	Automatic preventive maintenance.....	17			
6.3	Corrective maintenance.....	17			
7	Troubleshooting.....	18			
7.1	General.....	18			
7.2	Troubleshooting after installation.....	18			

1 Safety instructions and disclaimer

1.1 Safety instructions

Safety messages used in this document

	Warning! Risk of injury and damage. Ignoring warnings can cause personal injury and/or damage to products and other property.
	Caution! Risk of malfunctions. Ignoring cautions can cause the product to not operate as intended.
	Note Important information to the section in the manual.

Uponor uses safety messages in the document to indicate special precautions required for the installation and operation of any Uponor product.

Safety measures

	Note For safe and proper use, obey the instructions given in this document. Keep them for future reference.
---	---

The installer and operator agree to comply with following measures regarding Uponor products:

- Read and obey the instructions and processes in the document.
- The installation must be performed by a qualified installer in accordance with local regulations.
- Uponor is not liable for modifications not specified in this document.
- Switch off all connected power supplies before starting any wiring work.
- Do not expose the Uponor components to flammable vapours or gases.
- Do not use water to clean electrical Uponor products/ components.

Uponor is not liable for damage caused by ignoring the instructions in this document or the applicable building code.

Power

	Warning! Uponor system power supply: 230 V AC, 50 Hz. In case of emergency, immediately disconnect the power.
---	--

Technical constraints

	Caution! To avoid interference, keep data cables away from components bearing power of more than 50 V.
---	--

1.2 Correct disposal of this product (Waste Electrical and Electronic Equipment)

	Note Applicable in the European Union and other European countries with waste separation systems.
---	---



This icon on the product, or in the related documents indicates that it should not be disposed with household waste. Please, recycle responsibly to support the sustainable use of resources and prevent possible harm to human health and/or the environment.

Household users should contact the retailer where they purchased this product, or their local government office, for details on where and how they can take it for recycling.

Business users should contact their supplier and check the terms and conditions of the purchase contract. Do not dispose this product with other commercial waste.

1.3 Copyright and disclaimer

This is a generic, European-wide document version. The document may show products that are not available in your location for technical, legal, commercial, or other reasons.

For any questions or queries, please visit the local Uponor website or speak to your Uponor representative.

“Uponor” is a registered trademark of Uponor Corporation.

Uponor has prepared this document solely for information purposes, images are only representations of the products. The content (text and images) of the document is protected by worldwide copyright laws and treaty provisions. You agree to comply with these when using the document. Modification or use of any of the content for any other purpose is a violation of Uponor’s copyright, trademark, and other proprietary rights.

This disclaimer applies to, but is not limited to, the accuracy, reliability, or correctness of the document.

The presumption for the document is that the product related safety instructions are fully obeyed. The following requirements apply to the Uponor product (including any components) as covered by the document.

- The system (combination of products) is selected and designed by a competent planner. It is installed and put into operation by a licensed and/or competent installer in compliance with the instructions provided by Uponor. Locally applicable building and plumbing codes/regulations have been obeyed.
- Temperatures, pressure and/or voltage limits according to product and design information have not been exceeded.
- The product remains in its originally installed location and is not repaired, replaced, or interfered with, without prior written consent of Uponor.
- The product is connected to potable water supplies or compatible plumbing, heating and/or cooling systems approved or specified by Uponor.

- The product is not connected to or used with third-party products, parts, or components except for those approved or specified by Uponor.
- The product does not show evidence of tampering, mishandling, insufficient maintenance, improper storage, neglect, or accidental damage before installation and being put into operation.

While Uponor has made all effort to ensure that the document is accurate, the company does not guarantee or warrant the accuracy of the information. Uponor reserves the right to change the product portfolio and the related documentation without prior notification, in line with its policy of continuous improvement and development.

Always make sure that the system or product complies with current local standards and regulations. Uponor cannot guarantee the full compliance of the product portfolio and related documents with all local regulations, standards, or working methods.

Uponor disclaims all warranties related to the content of this document, expressed or implied, to the fullest extent permissible unless otherwise agreed or statutory.

Uponor is under no circumstances liable for any indirect, special, incidental, or consequential damage/loss that results from the use or inability to use the product portfolio and related documents.

This disclaimer and any provisions in the document do not limit any statutory rights of consumers.

2 System description

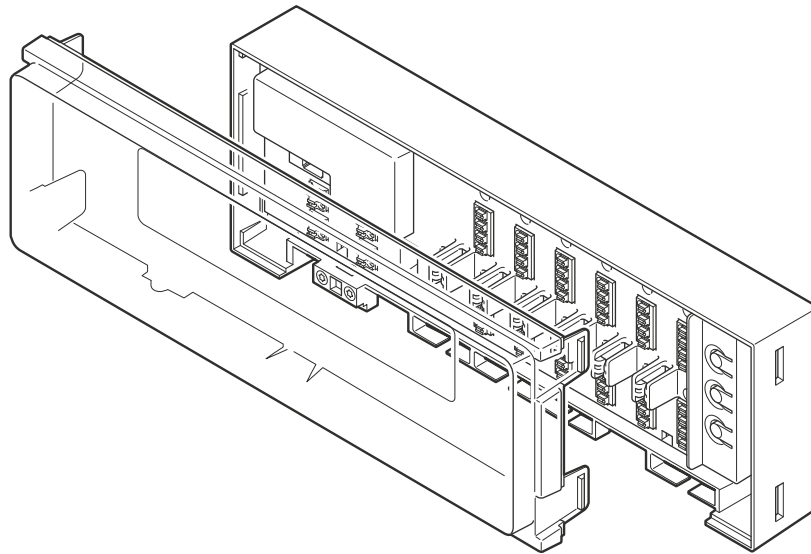

CD000065

Uponor Base controller H pump X-60 6x 230V (controller X-60) is one of the core components in radiant heating systems. It controls the heating source, pump, and actuators to adjust the indoor temperature in each room based on transmitted demand signals from the thermostats.

2.1 Autobalancing for more comfort and efficiency

When a conventional radiant heating system is installed, it is necessary to balance it manually to make sure that each room receives the required output. If the system is kept unbalanced with a constant flow rate, some rooms can be overpowered while others are underpowered. A system that is not properly balanced requires more energy to adequately heat all rooms.

The autobalancing technology of the controller X-60 offers a more energy efficient system than a manually balanced system. It constantly calculates and adjusts the accurate energy quantity to keep an optimal comfort in each room. Another advantage is that it is not necessary to balance the system during the initial start.

In renovation projects, the autobalancing feature can easily be adapted to an available installation without any new calculation. In a conventional radiant heating system, also small changes in a building interior can have an effect on the temperature balance. One reason can be that the required quantity of water at a given supply temperature is necessary to change due to a replacement of floor covering. The autobalancing feature in the controller X-60 can automatically adapt to these changes, to keep the comfort.

2.2 System compatibility

Note

For more detailed information, product range and documentation please visit the Uponor website: www.uponor.com.

The autobalancing controller X-60 is compatible with Uponor Base thermostats 230 V. This controller is also compatible with other 230 V thermostats available on the market.

Third-party thermostats



Warning!

The installer must make sure that the thermostat is compatible with the controller before the installation is done.

Following minimum requirements must be obeyed if third-party thermostats should be connected to the controller.

- 2 wires for power supply 230 V
- 1 output 230 V for the demand

Following feature is an optional requirement.

- Day/night input

2.3 Controller features

Main hardware characteristics of this controller:

- 230 V AC input.
 - 1 power LED (green).
- Digital inputs: day/night switch.
- Pump relay.
- Can operate up to 6 thermostats:
 - 4 connectors per thermostat (L – N – Demand and output for day/night switch).
 - 6 red thermostat channel LEDs, which are used during the connection process.
- Can operate up to 12 actuators, with 2 actuators at a time that follow a common thermostat:
 - 6 double noiseless actuator outputs (triacs).
 - 6 bi-colour actuator output LEDs which are used during the connection process and to indicate the actuator status.
- 3 push buttons: Thermostat (>), "OK", Actuator (>).
- 1 switch to enable/disable the autobalance function.

Software features

Main characteristics of the controller software:

- Output management (set by default).
 - Autobalancing (set by default).
 - ON/OFF outputs management.
- Pump management.
- Valve exercise.
- Day/night switch.
- Assignment of input – output (thermostats – actuators).
- Factory reset.

2.4 Components of the controller

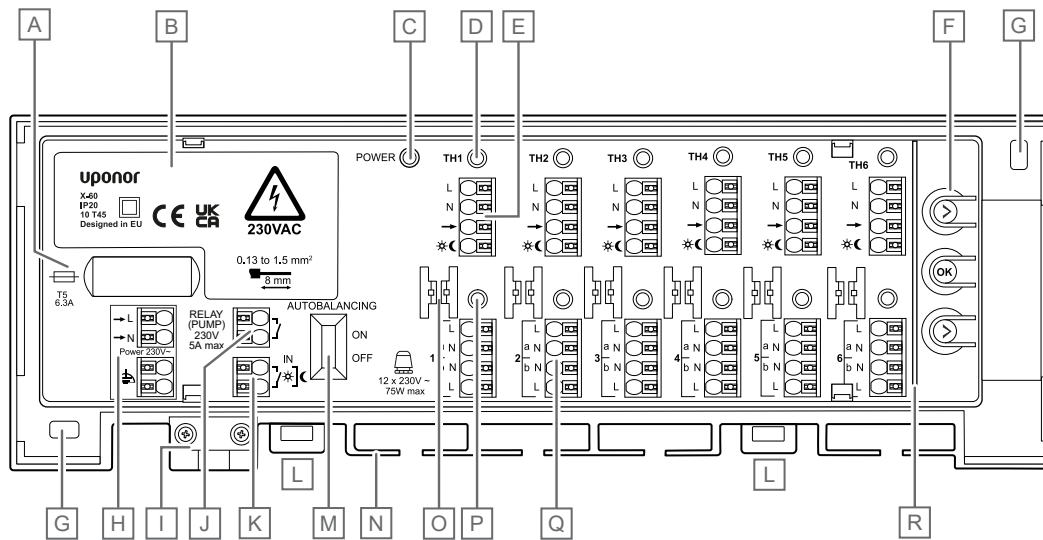

CD0000591

Item	Description
A	Fuse (T5 6.3 A)
B	Power module 230 V AC, 50 Hz
C	Power LED
D	LEDs for thermostat channels 1-6 (TH1-TH6)
E	Thermostat connection terminals 1-6
F	Push buttons for channel registration
G	Holes for wall installation
H	Power input 230 V AC
I	Strain relief for the 230 V power cable
J	Optional output for pump management (ON/OFF switch)

Item	Description
K	Day/night input
L	Clips to lock and unlock the controller from the DIN rail
M	Autobalancing switch
N	Cable entry
O	Cable guides
P	LEDs for actuator channels 1-6
Q	Actuator output, 12 terminals (1a-1b, 2a-2b ... 6a-6b)
R	Safety partition between the push buttons and the connection terminals

Overview of the LED colours

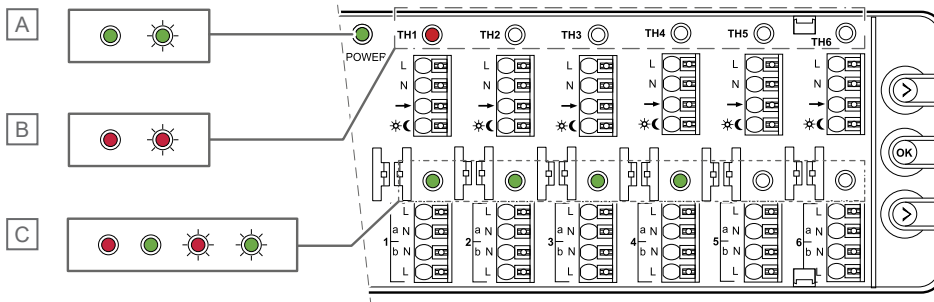

CD0000594

Item	Description	Condition		
		Colour	Assignment mode	Run mode
A	Power LED	Solid green		Run mode ON
		Flashing green	Assignment mode ON	
B	Thermostat channel LED	Solid red	Thermostat selected/assigned	
		Flashing red	Thermostat pointed	
C	Actuator channel LED	Solid red		Heating demand
		Solid green	Actuator assigned	
		Flashing red	Actuator pointed	
		Flashing green	Actuator selected	

The different controller LEDs and their colours are clarified in separate sections in this document.

Push buttons for channel registration

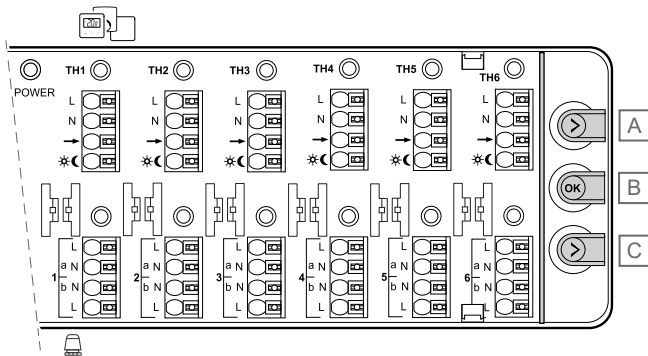

CD0000595

Item	Description
A	Thermostat button (>)
B	"OK" - confirmation button
C	Actuator button (>)

There are 3 push buttons on the right-hand side of the controller. They are used for assignment, and for factory reset.

Label with a QR code on the cover

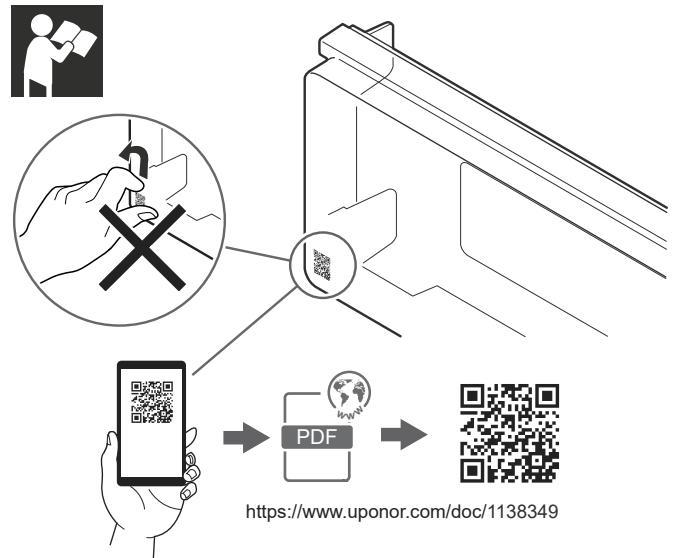

SI0000633

There is a label with a QR code in the lower left-hand corner of the transparent cover. It is a link to the product documentation on the website.

Do not remove this label. Keep it for future reference to easily find the related documentation.

Safety partition



Warning!

Risk of electric shock!

Do not touch the connected cables when the controller is powered. The unit operates with a 230 V AC voltage.

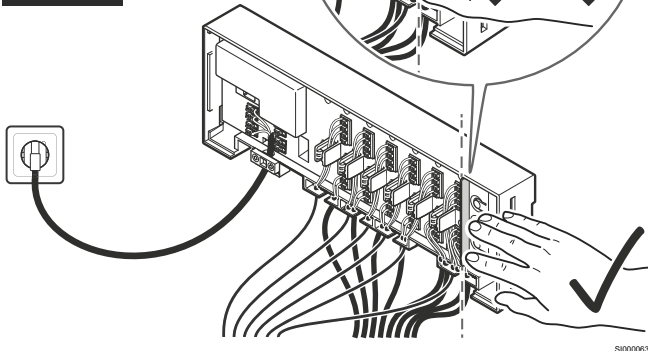



S10000631

There is a safety partition between the push buttons for channel assignment, and the thermostat - and actuator connection terminals. This wall prevents that the fingers accidentally touch the connected cables during the assignment.

The cables are under power supply during the assignment and can cause an electric shock if a cable is not correctly connected.

3 Operation

3.1 Controller cover opening

	Warning! Uponor system power supply: 230 V AC, 50 Hz. In case of emergency, immediately disconnect the power.
	Warning! Preferably use a 5 mm screwdriver to remove the transparent cover. A too large screwdriver can damage the controller parts.

Any installation and assignment that should be done requires that the transparent cover is removed from the controller body. There are two (2) clips on each side of the cover that locks the cover to the body.

Follow these steps to remove the transparent cover.

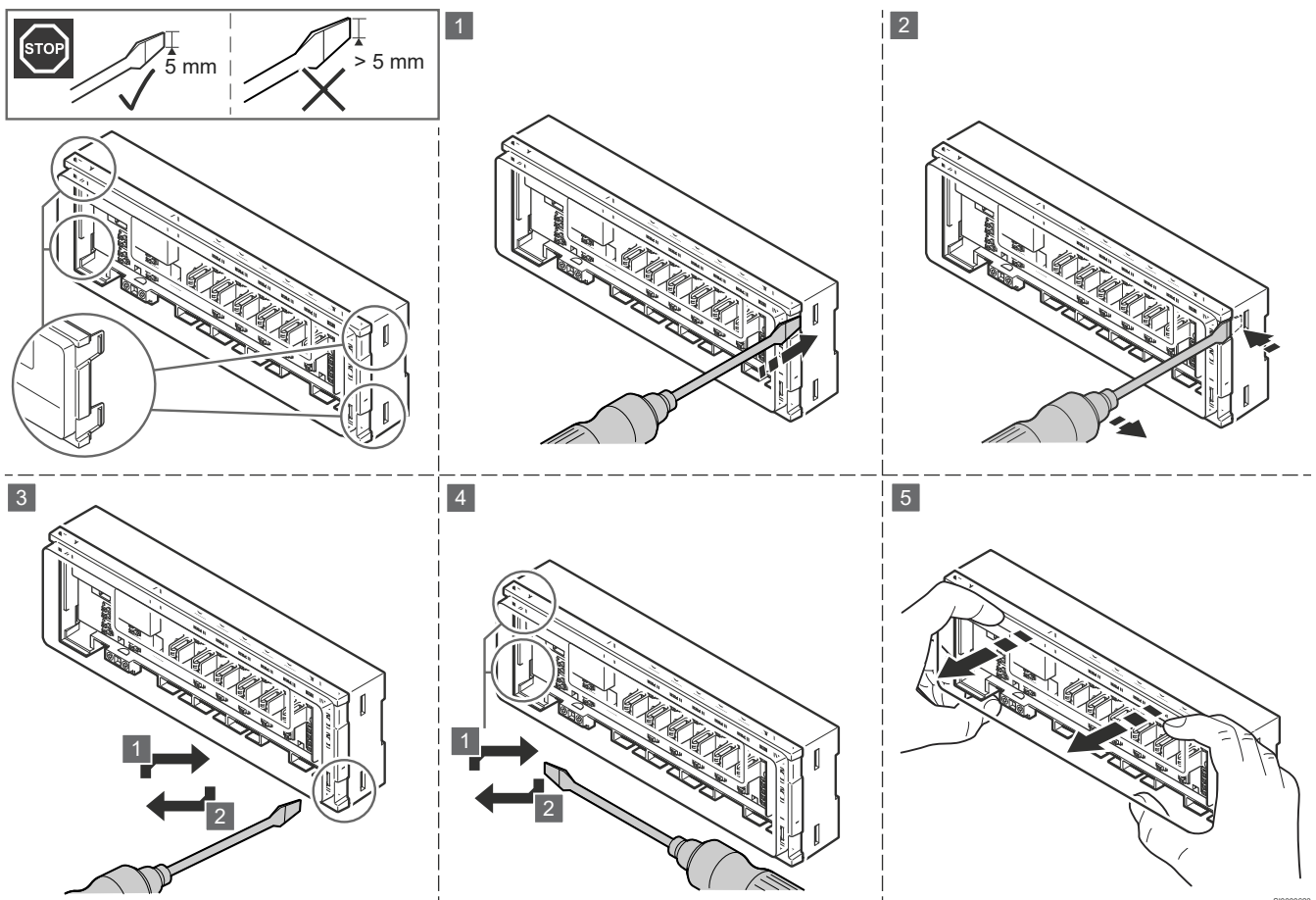

1. Position a flat screwdriver in the clip hole in the first corner.
2. Gently push the screwdriver to the opposite side of the controller body to release the first clip.
3. Repeat steps 1 and 2 on the second clip.
4. If necessary, repeat the steps 1 and 2 on the other side of the controller.
5. Use your hands to gently remove the cover from the controller body.

3.2 Controller operation principle

	Warning! The autobalancing controller 230 V is compatible only with 230 V thermostats.
---	--

The autobalancing controller operates the radiant heating system based on customer needs. The indoor temperatures are measured and adjusted with thermostats located in each room.

If the temperature in a room is lower than the setpoint temperature, the thermostat sends a demand signal to the controller to change the temperature. The controller opens the related actuator based on current operating mode and settings. Once the set temperature is reached in the room, the signal from the thermostat stops and the controller closes the actuator.

3.3 Start the controller

The first time the controller is started, it is by default in assignment mode since no thermostat or actuator has been assigned yet. If no button is pushed during 10 minutes, the controller goes to run mode.

When at least one thermostat and actuator have been assigned, the controller starts in run mode by default.

3.4 Operating modes

The controller X-60 can operate in two different modes. Each mode is described in a separate chapter.

Chapter	Operating mode
4	Run mode
5	Assignment mode

The controller is in run mode during normal operation.

4 Run mode

4.1 Example of a controller in run mode

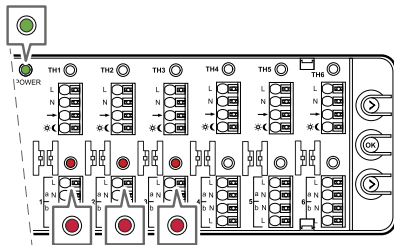

Run mode - thermostat 1 (channel 1 and 2) and thermostat 2 (channel 3) with heating demand.

The controller is in run mode during normal operation.

The power LED is solid green when the system is powered.

The controller opens and closes the actuators based on demand signals from the thermostats and the setup of the system. An affected actuator LED shows a solid red light when there is a heating demand.

4.2 Features

Section	Feature
4.3	Autobalancing
4.4	ON/OFF outputs management
4.5	Pump management
4.6	Valve exercise
4.7	Day/night switch
4.8	Factory reset

The available features in run mode are given in separate sections.

4.3 Autobalancing

Note

The Uponor Base controller can operate the actuator outputs either by ON/OFF signals directly given by the thermostats, or by the autobalancing.

Autobalancing is ON by default.

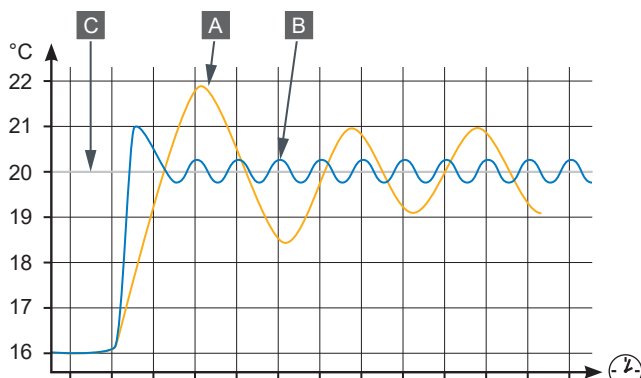

D1000016

Item	Description
A	Manual balancing
B	Autobalancing
C	Setpoint value

Autobalancing is a feature where the system calculates the actual energy demand in the individual rooms, and adjusts the output of each loop based on its length. This means that a short loop can receive 20 % of the output while a long loop can receive about 60 %.

The autobalancing continues throughout the seasons, changed lifestyle and usage patterns in the household, and prevents the need of manual balancing. The ON/OFF signals are calculated by an algorithm. This gives smoother floor temperatures and faster system reaction times with lower energy consumption than a standard ON/OFF system.

A manual hydraulic balancing only takes the initial conditions and calculations into account. The autobalancing feature adjusts the changes in the system or room automatically without any need for the installer to make complex re-calculation or adjustment.

When autobalancing is ON, also during periods of demand, the actuators are opening and closing to make sure that only the required energy is used by the room. There is a time limit bypass function in the controller to avoid that the pump and/or boiler is damaged due to short ON/OFF periods. If the last ON period is too short, the remaining open actuator stays open until there is a demand in another room or during maximum 30 minutes.

4.4 ON/OFF outputs management

Bi-metal or electronic ON/OFF thermostats that are connected to the radiant heating system send demand signals to the controller.

When there is no heating demand from the thermostat to the controller, the LEDs of the actuators assigned to the thermostat are turned OFF. The actuators are closed.

When the controller receives a heating demand signal from a thermostat, the affected actuators open. The actuator channel LEDs are solid red to indicate the demand status.

4.5 Pump management

The pump is powered externally. The relay switch turns ON the pump when an actuator is open due to a demand.

If any actuator is open due to a valve exercise, the pump is not activated.

There is a delay of 2 minutes during the pump startup (when it goes from stop mode to run mode). During this time, the actuator opens completely to make sure that there is a water flow.

4.6 Valve exercise

The controller is equipped with an automatic valve exercise function. This function prevents the valve and actuators from sticking due to inactivity. The exercise operates if a valve is closed for 3,5 days. During this exercise, the valve is open for 2 minutes.

This valve exercise does not create any demand signal. Hence the pump is not activated during the exercise. The actuator LED will not turn ON as there is no demand.

4.7 Day/night switch

When thermostats with day/night functions are connected to the controller X-60, the function can be used in the underfloor heating system. The controller sends a signal to those thermostats to switch between day and night mode.

4.8 Factory reset

Note

All thermostat and actuator assignments are deleted when the controller is reset to factory settings.

Follow these steps to factory reset the controller when it is in run mode.

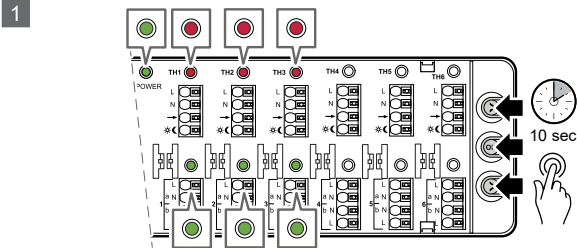

CD0000592

1. Press and hold all 3 buttons for up to 10 seconds.

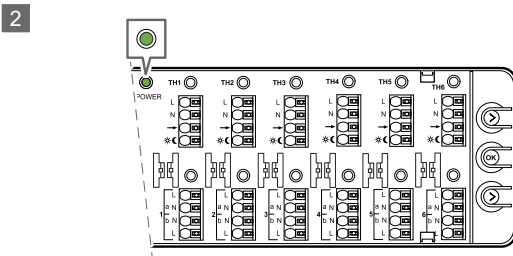

CD0000593

2. All the thermostat and actuator assignments are deleted.

5 Assignment mode



IC0000155

	Warning!
	Risk of electric shock! Do not touch the connected cables when the controller is powered. The unit operates with a 230 V AC voltage.
	Caution!
	Always complete the connection of all cables before the assignment procedure starts.
	Note
	The illustrations that are used in this document to visualise the step instructions give the controllers without any cables connected. This is done only to increase the readability of the illustrations.

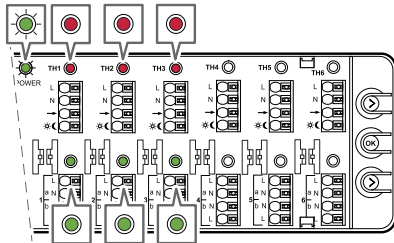

CD0000588

When the thermostats and actuators have been correctly connected to the controller, they must be assigned to the controller. The assignment is done in the **assignment mode** in the controller.

The power LED flashes green when the operating mode in the controller has been changed to assignment mode and the system is ON.

The LEDs in already assigned thermostat channels are solid red. In the assigned actuator channels the LEDs are solid green.

5.1 Change from run mode to assignment mode

	Note
	There is a timeout function in the controller. If no button is pushed for 10 minutes, the system goes back to run mode.

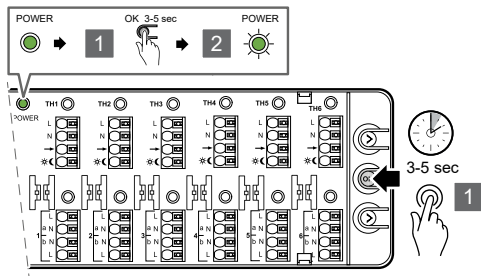

CD0000590

Follow these steps to change from run mode to assignment mode.

1. Push and hold the button "OK" for 3-5 seconds.
2. The power LED starts to flash green to show the change to assignment mode.

5.2 Set up the assignment mode

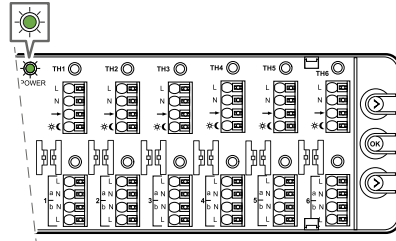

CD0000586

When the assignment mode should be Initially set, only the power LED flashes green. There is no actuator assigned to any thermostat.

5.3 Enter the assignment mode with assigned thermostats/actuators

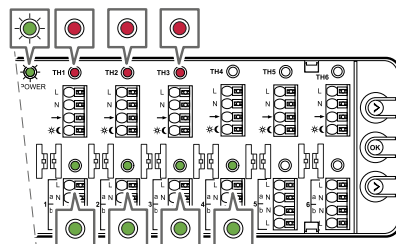

CD0000587

When the assignment mode is entered once some of the thermostats and actuators have been assigned, the power LED flashes green. The assigned thermostat LEDs are solid red. The LEDs of the assigned actuators are solid green.

5.4 Assign the thermostats and actuators

The controller can only operate when the thermostats and actuators have been assigned to it. This can be done in two possible procedures, either assign the thermostat first or the actuator first. In both procedures, the push buttons in the controller are used to make the assignments.

A – Select the first thermostat to be assigned

- This section gives the procedure to assign the thermostat before the actuator.

B – Assign another thermostat with related actuator

- This section gives the procedure to assign the actuator before the thermostat.

A – Select the first thermostat to be assigned

Note

If the button "OK" is pushed and held for 3–5 seconds without any selected actuator channel, the system goes back to run mode. No assignment is made.

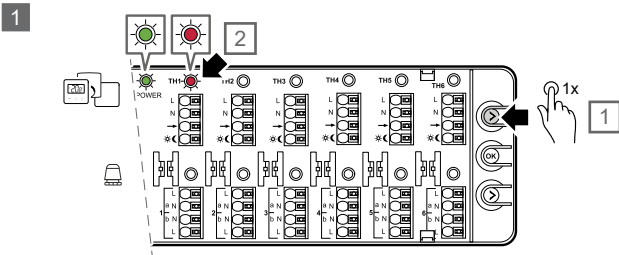

SI0000563

Use the thermostat button to point and select a thermostat.

1. Push the thermostat button (>) once.
 - The first available thermostat is pointed, and its LED starts to flash red.

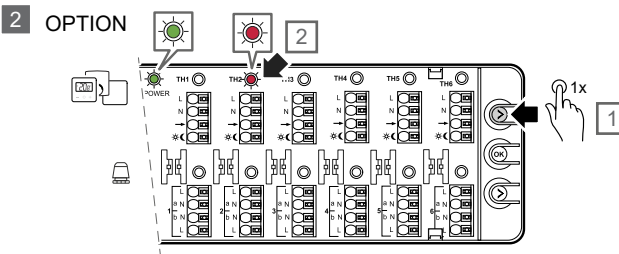

SI0000565

2. If necessary, push the thermostat button (>) again to point the next thermostat channel.
 - When the last thermostat channel is reached, the procedure starts from channel 1 again.

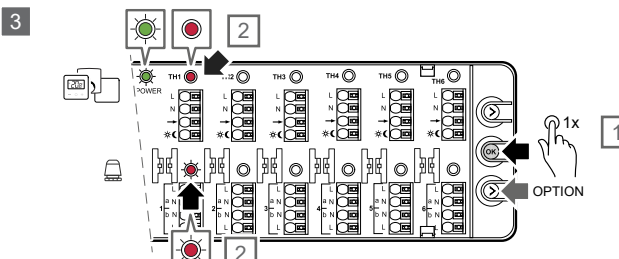

SI0000567

3. When the desired thermostat is pointed (flashing red), push the button "OK" to select it.
 - The thermostat channel LED changes to solid red.
 - At the same time, the first available actuator channel LED starts to flash red.
 - OPTION: If another actuator channel should be selected instead, push the actuator button (>) until the correct channel is pointed and its LED flashes red.

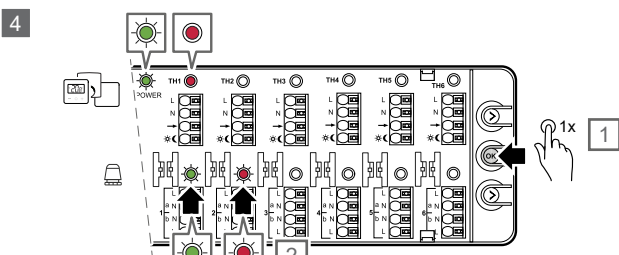

SI0000569

4. Push the button "OK" to select the actuator.

- The LED in the pointed actuator channel starts to flash green.
- At the same time, next available actuator channel is pointed and the LED starts to flash red to show where the pointer is.
- OPTION: If another actuator channel should be selected instead, push the actuator button (>) until the correct channel is pointed and its LED flashes red.

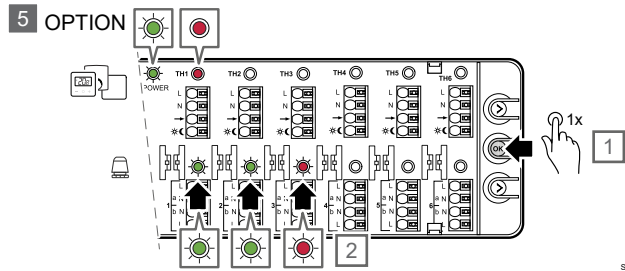

SI0000570

5. If an additional actuator should be selected, point it (the actuator LED flashes red), and push the button "OK".
 - The LED in the selected actuator channel changes from flashing red to flashing green.
 - At the same time, next available actuator channel is pointed and the LED starts to flash red to show where the pointer is.
 - OPTION: If another actuator channel should be selected instead, push the actuator button (>) until the correct channel is pointed and its LED flashes red.
 - OPTION: Repeat step 5 if necessary to select all actuators that should be assigned to the selected thermostat.

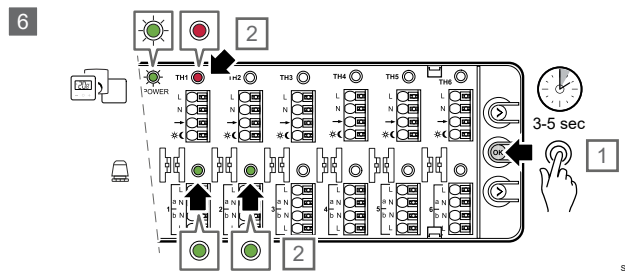

SI0000571

6. Push and hold the button "OK" for 3-5 seconds to confirm the assignment of the selected thermostats and actuators.
 - The assignment between the selected thermostat and the related actuator channels is completed.
 - The LEDs in the pointed actuator channels change from flashing green to solid green.
 - At the same time, the LED in next available actuator channel turns OFF.
 - The power LED continues to flash green as the assignment mode is still active.
7. If more thermostats and actuators should be added, repeat the steps 1-6 or continue with option B.
8. When the assignment is completed, change back to run mode. See the section "Change back to run mode".

B – Assign another thermostat with related actuator

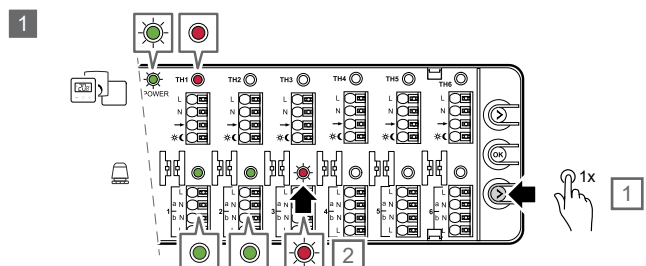

SI0000562

1. Push the actuator button (>) once.
 - The first available actuator channel is pointed, and its LED starts to flash red.
 - If another actuator channel should be pointed, repeat the step.

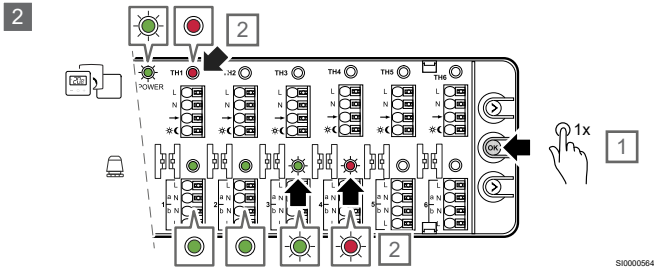

SI0000564

2. Push the button "OK" once to confirm the selection.
 - The selected actuator channel LED starts to flash green.
 - At the same time, next available actuator channel is pointed and the LED starts to flash red to show where the pointer is.
 - If applicable, repeat step 2 and 3 until all desired actuator channels are selected.

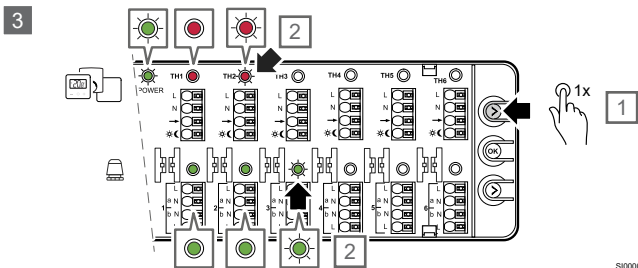

SI0000566

3. When the desired actuator channels are selected and their LEDs are flashing green, push the thermostat button (>) once.
 - The LED in the first available thermostat channel starts to flash red.
 - The LEDs for the selected actuator channels flash green.
 - At the same time, the LED in next pointed actuator channel that was flashing red turns off. The pointer goes to point the thermostats.
 - To point to another thermostat channel instead, push the thermostat button (>) once again. The LED in next available thermostat channel starts to flash red.
 - When the last thermostat channel is reached, the procedure starts from channel 1 again.

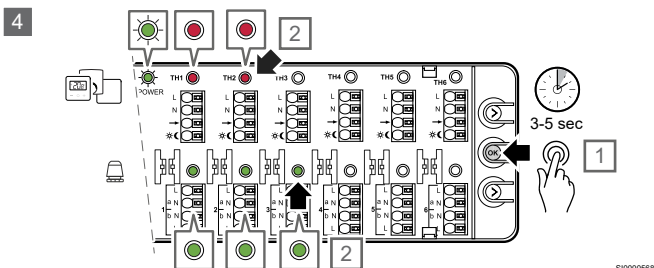

SI0000568

4. When the desired thermostats and actuators are selected, push and hold the button "OK" for 3-5 seconds.
 - The thermostat LED is solid red, and the actuator LED is solid green.

The assignment between the selected thermostat and the related actuator channels is completed.

5.5 Check assigned channels

When the controller is in run mode, follow these steps to check the assignment between a thermostat and its actuators.

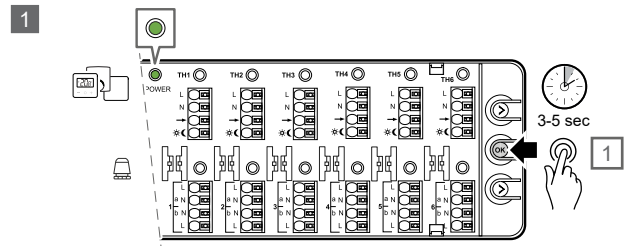

SI0000572

1. Push and hold the button "OK" for 3-5 seconds to change to assignment mode.

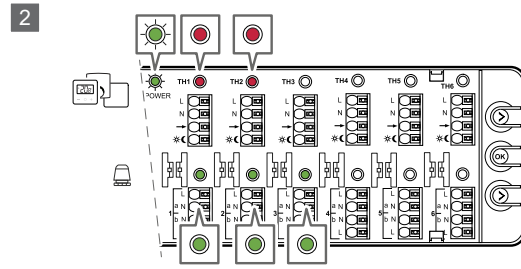

SI0000573

2. The power LED starts to flash green to show the change to assignment mode.
 - The assigned thermostat LEDs are solid red.
 - The assigned actuator LEDs are solid green.

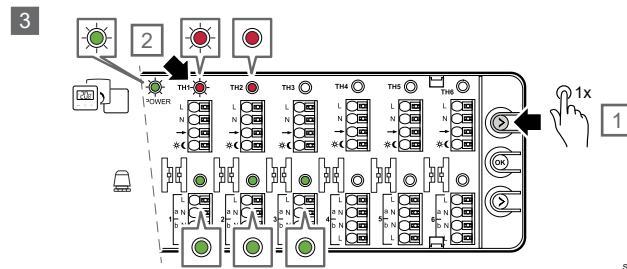

SI0000574

3. Push the thermostat button (>) once.
 - The LED in the first available thermostat channel starts to flash red.
 - To point to another thermostat channel instead, push the thermostat button (>) as many times as necessary to reach the desired thermostat.

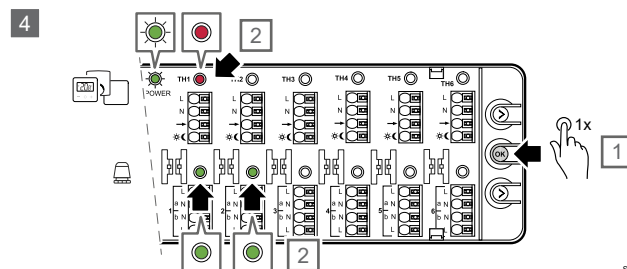

SI0000575

4. Push the button "OK" once to confirm the selection.
 - Only the selected thermostat with its assigned actuators is visible.

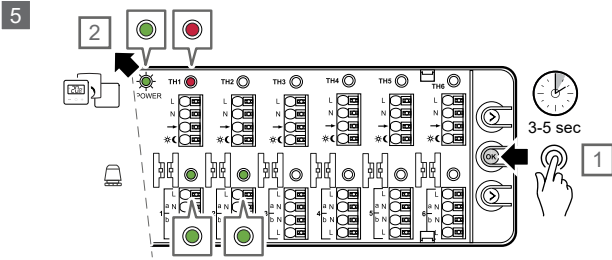

5. Push and hold the button "OK" for 3-5 seconds to change back to run mode.

5.6 Remove assigned channels

Note

Assignment mode is required to remove assigned channels.

When an assignment is incorrect for any reason, it is possible to remove it.

When the controller is in run mode, follow these steps to remove the assignment between a thermostat and its actuators.

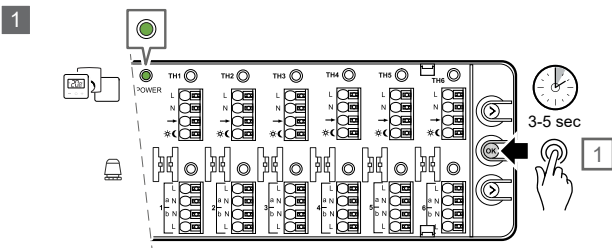

1. Push and hold the button "OK" for 3-5 seconds to change to assignment mode.

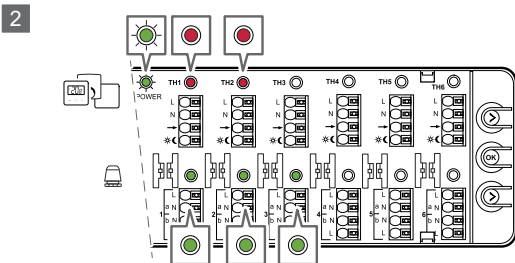

2. The power LED starts to flash green to show the change to assignment mode.

- The assigned thermostat LEDs are solid red.
- The assigned actuator LEDs are solid green.

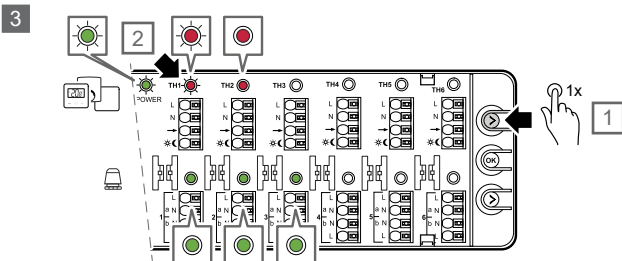

3. Push the thermostat button (>) once.
 - The LED in the first available thermostat channel starts to flash red.

- To point to another thermostat channel instead, push the thermostat button (>) as many times as necessary to reach the desired thermostat.

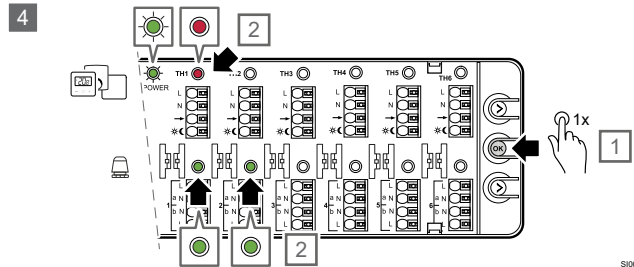

4. Push the button "OK" once to confirm the selection.

- Only the selected thermostat with its assigned actuators is visible.

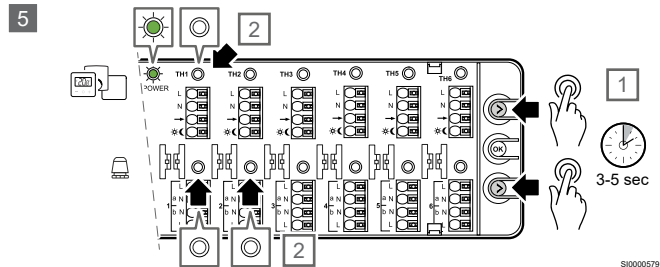

5. If this assignment should be removed, push the thermostat (>) and actuator (>) buttons simultaneously for 3-5 seconds.

- The LEDs in the selected thermostat and actuators turn OFF.

- The assignment is removed.

- The system changes back to run mode and normal operation.

- The power LED changes to solid green.

6. If necessary, follow the assignment process to re-assign the removed thermostat with related actuators.

- See the above section "Assign thermostats and actuators".

5.7 Change back to run mode

Note

There is a timeout function in the controller. If no button is pushed for 10 minutes, the system goes back to run mode.

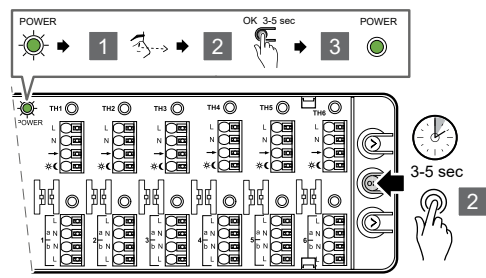

Follow these steps to change back to run mode from assignment mode.

1. Check that no actuator is selected.
2. Push and hold the button "OK" for 3-5 seconds.
3. The power LED changes from flashing green to solid green to show that the controller is back in run mode.

6 Maintenance

6.1 Manual preventive maintenance



Note

Use only a dry, soft cloth to clean the Uponor products.
Do not use any cleanser.

The controller requires no preventive maintenance.

6.2 Automatic preventive maintenance

The controller is equipped with an automatic valve exercise function. This function prevents the valve and actuators from sticking due to inactivity. The exercise operates if a valve is closed for 3,5 days. During this exercise, the valve is open for 2 minutes.

This valve exercise does not create any demand signal. Hence the pump is not activated during the exercise. The actuator LED will not turn ON as there is no demand.

6.3 Corrective maintenance

Reset the controller

It can be necessary to reset the controller if it does not operate correctly, for example due to a hang-up.

- Disconnect and reconnect the controller to the AC power.
- The disconnection from the AC power does not have any effect on the adjustments made in the controller. They will stay also after the reconnection.

7 Troubleshooting

7.1 General



Warning!

Always disconnect the 230 V power supply before the internal connections in the controller terminals are accessed.

This section describes general problems and alarms that can occur with the controller X-60 and describes possible solutions.

A common cause can be incorrectly installed pipe loops in the system or mixed up thermostats.

- Make sure that the controller is connected to the 230 V AC power supply.
- Make sure that all cables are correctly connected.
- Make sure that the thermostats and actuators are correctly assigned, see the chapter "Check assigned channels".

The floor temperature is changing abnormally between hot and cold in heating mode

- The supply water temperature is too high.
 - Examine the boiler or shunt.

The room temperature does not align with the thermostat setpoint

- The room thermostat is installed in direct sunlight or near other heat sources.
 - Make sure that the position of the thermostat refers to the installation manual.
 - Change position if necessary.
- The room thermostat is installed in the wrong room.
 - Make sure that the thermostat position is correct.
 - Make sure that the thermostat and actuator assignments are correct.

The room is too cold

The thermostat setpoint is too low

- The thermostat setpoint is too low.
 - Change the temperature setpoint.

The white indicator cannot be seen in an actuator

- An actuator does not open.
 - Replace the actuator.
 - Speak to the installer.

The room is too warm

A related loop is warm also after a long period without any heating demand

- An actuator does not close.
 - Speak to the installer.
 - Make sure that the actuator is correctly installed.
 - Replace the actuator.

The room is too warm also after a long period without any heating demand

- Make sure that the room is not heated by another source, for example sunlight, a fireplace or an oven.

The floor is cold

The room temperature is satisfactory but the floor is cold

- There is no heating demand signal from the radiant heating system.
- The room is heated by another source, for example sunlight, a fireplace or an oven.

7.2 Troubleshooting after installation

The system does not start

The power LED in the controller is off

- There is no 230 V AC power supply to the controller.
 1. Make sure that the controller is connected to the AC power supply.
 2. Remove the power plug.
 3. Make sure that the wires in the 230 V compartment are correctly connected.
 4. Make sure that there is 230 V AC power supply in the wall socket.

There is 230 V AC power supply in the wall socket

- The controller fuse has blown or the power cable is faulty.
 - Replace the fuse and/or the power cable and plug.

The actuator is open but there is no flow

- The pump does not operate.
 - Make sure that the pump is not stuck.
 - Make sure that the power supply voltage is correct.
- The valve exercise is operating.
 - The actuator LED is OFF because there is no demand signal.
 - The exercise can occur every 3,5 days and operates during 2 minutes.
- There is a demand signal and the LED is fixed red, but the pump delay at startup (2 minutes) is not completed.
- The actuator can be defect.
 - If none of the above given solutions solves the problem and it continues, replace the actuator or speak to the installer.

There is no demand signal but the actuator is open

- The valve exercise is operating.
 - The actuator LED is OFF because there is no demand signal.
 - The exercise can occur every 3,5 days and operates during 2 minutes.
- The autobalance switch is ON.
 - As a result of the time limit bypass function, the remaining open actuator stays open until there is a demand in another room or during maximum 30 minutes.
 - All actuators are closed to prevent an extra boiler and pump startup due to autobalance algorithm behaviour.

There is a demand signal but the actuator is closed

- The autobalance switch is ON and the autobalance algorithm operates in the OFF cycle for that actuator.
 - The actuator should open in less than 30 minutes if the demand signal continues.
 - If necessary, speak to the installer. The actuator can be defect.

8 Technical data

8.1 Technical specifications

Description	Value
Product name	Uponor Base controller H pump X-60 6x 230V
Dimension	265 x 90 x 56 mm
Weight	590 g
Purpose of control	Automatic control
Construction of control	Electronic independently mounted control
Method of disconnection	Type X
Type of action	Type 1C (micro-interruption)
Degree of protection	IP20, class II (IP: degree of inaccessibility to active parts of the product and degree of water)
Max. ambient RH (relative humidity)	85 % at 20 °C
Marking	CE, UKCA
ERP	I
Low voltage tests	EN 60730-1* and EN 60730-2-9**
EMC (electromagnetic compatibility requirements) tests	EN 60730-1
Power supply	230 V AC +10/-15 %, 50 Hz or 60 Hz
Internal fuse (valve protection)	T5 6.3A
Rated impulse voltage	2,5 kV, OVC II
Control pollution degree	2
Software class	A
Operating temperature	-10 °C ... +45 °C
Storage temperature	-20 °C ... +60 °C
Temperature for ball pressure test	100 °C
Extension of sensing element	Temperature
Regulation cycle time for load command	2 min / 10 min / see parameters
External load on valve output	230 V / 75 W max per output – valves
External fuse protection on the installation required	5 A fuse on both relay output
Maximum consumption	Without load 3 W
Day/night switch input	Only dry contact
Valve outputs	230 V
Pump relay output	5 A / 230 V max – resistive only
Connection terminals	0,13 ... 1,5 mm ²
Power supply cable (not included)	Ø min. 6,5 ... max. 8,0 mm
Command interface	Keyboard, 3 keys

*) EN 60730-1 Automatic electrical controls for household and similar use -- Part 1: General requirements

**) EN 60730-2-9 Automatic electrical controls for household and similar use -- Part 2-9: Particular requirements for temperature sensing controls

Regulatory conformance

The wired Uponor Base controllers comply with the following directives.

- CE
- UKCA

EU/UK Declaration of conformity

Hereby, Uponor declares that the wired Uponor Base controllers are in compliance with the relevant Community harmonisation legislation. ¹⁾



The full text of the EU/UK declaration of conformity is available at the following internet address:

<https://www.uponor.com/doc/1138349>

1) Refer to the related Uponor product for the specified certification and compliance marks.

Additional product information and instructions are delivered with the Uponor product. They are available at the website www.uponor.com/services/download-centre and at the national Uponor websites in local language.



8.2 Dimensions

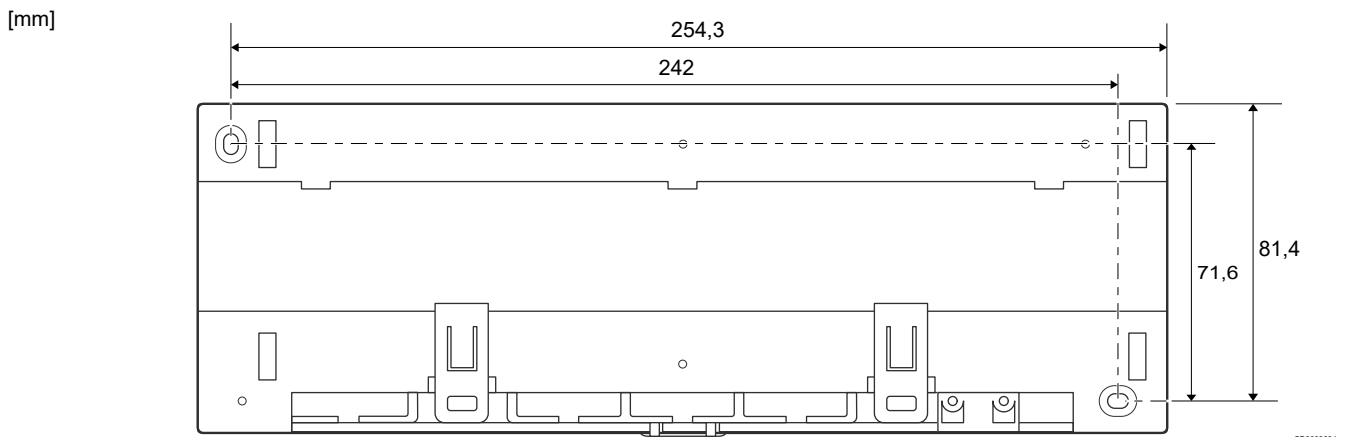
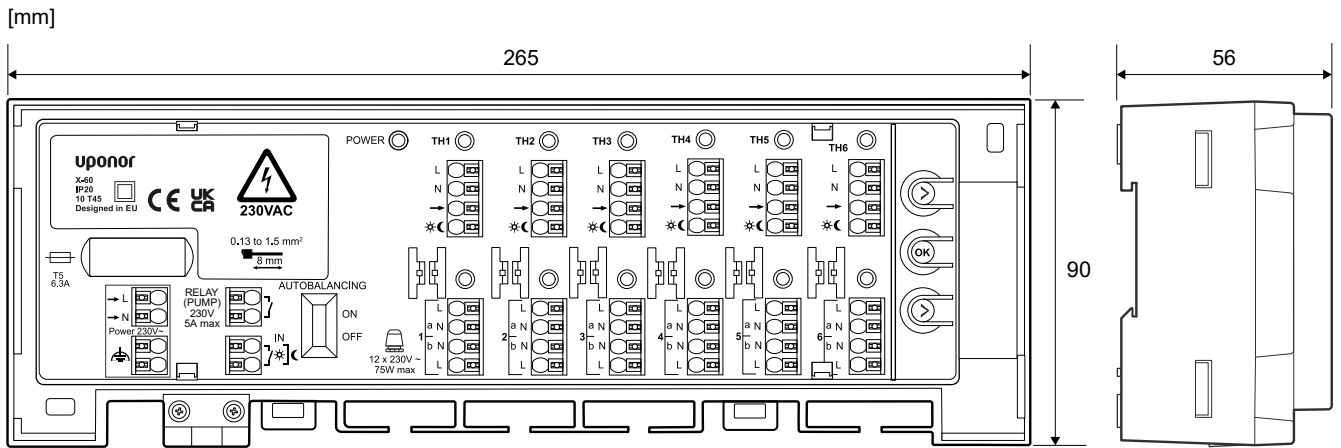

8.3 Wiring diagram

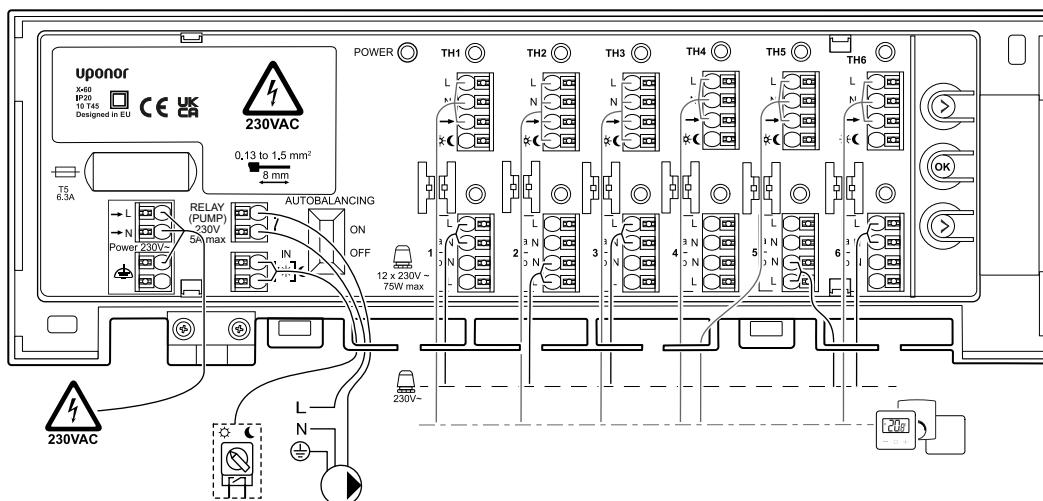

Uponor

Uponor GmbH

Industriestraße 56,
D-97437 Hassfurt, Germany

1139822 v2_10_2023_EN
Production: Uponor/ELO

Uponor reserves the right to change the product portfolio and the related documentation without prior notification, in line with its policy of continuous improvement and development.



www.uponor.com