

**Oil Separator Bypass**  
**Technical Datasheet**

**Uponor**



# Uponor oil separator PE-30/300-3 Bypass 10



- Fulfills class 1 requirements of harmonized standard EN-858
- Integrated by-pass. 10 x NS
- Flexible installation with separate riser pipe and cover, adaptable to the project specification.
- Can be used in traffic load areas without using extra load bearing plates.
- Separate alarm system for full control of operation.
- Maintenance performed from ground level. (No entry needed)

## Intended use

Oil and sand separators are designed for separating mineral suspensions that settle in liquid wastes and oil and petrol substances that cannot be introduced into the receiving body of water, sewage system or local sewage treatment plants.

The series of separators are used for purifying rain sewage obtained by draining streets and car parks, purifying industrial waste from engineering industry, petrol stations, automated and hand car washed, garages etc.

Separator is designed to be used in passageways with circular traffic.

Application	Storm water / Wastewater
Uponor no	1143214
RSK/LVI/VVS	-
Material	PEHD
NS (l/s)	30
Max flow (l/s)	300
Sludge trap	Small
Weight (kg)	390
Standards	EN-858
DoP	CPR-20-OIL-1201

# Properties

System properties	Standard
Class 1 oil separator, with integrated sludge trap, integrated bypass, coalescing filter, auto closing valve and inlet deflection	EN-858
<p>The separator tank is made of PE-HD polyethylene. All inside equipment is made of PE-HD or acid resisting steel.</p> <p>Inspection holes to be extended with IQ-600 PP extension system.</p> <p>Alarm system installed separately.</p> <p>*/**Sensor levels for alarm system in table below.</p> <p>*50%, **80% of total storage volume. Dimension from separator bottom to sensor level.</p>	

Working parameters	NS (l/s)	Sludge trap (dm <sup>3</sup> )	Oil capacity (dm <sup>3</sup> )	Sludge level* (mm)	Oil level* (mm)
Maximum values	30	3000	603	746	2040
Dimensions	H (mm)	ID (mm)	OD (mm)	DN (mm)	B (mm)
Value	3250	1600	1790	400	2280

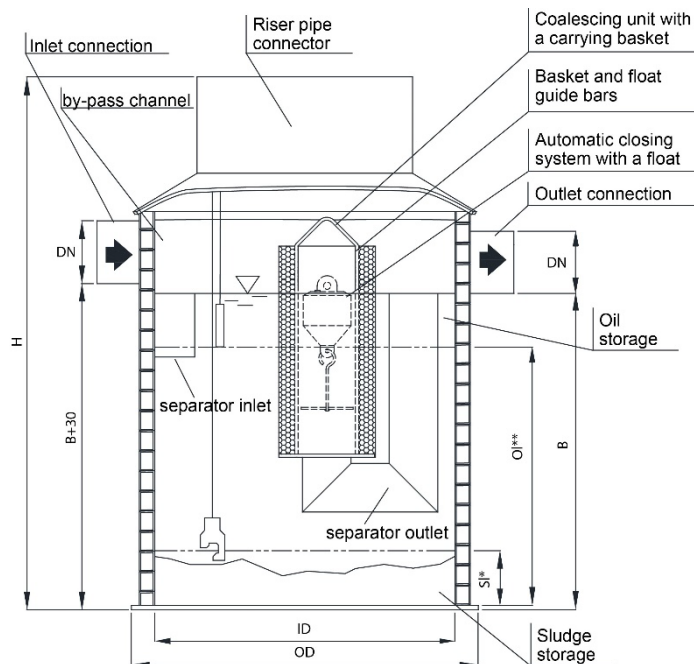

# Moving > Water

**uponor**

**Uponor Corporation**

Ilmalantori 4

00240 Helsinki

Finland

**T** +358 (0)20 129 211

**F** + 358 (0)20 129 2841

[www.uponor.com](http://www.uponor.com)